



MODEL Y

OWNER'S MANUAL



Software version: 2024.38
New Zealand

YOUR OWNER'S MANUAL

For the latest and greatest information that is customized to your vehicle, view the Owner's Manual on your vehicle's touchscreen by touching the app launcher and then selecting the Manual app. The information is specific to your vehicle depending on the features you purchased, vehicle configuration, market region, and software version. In contrast, owner information that is provided by Tesla elsewhere is updated as necessary and may not contain information unique to your vehicle.

RELEASE NOTES

Information about new features is displayed on the touchscreen after a software update, and can be viewed at any time by choosing the **Release Notes** tab in the Manual app, or by touching **Controls > Software > Release Notes**. If the content in the Owner's Manual on how to use your vehicle conflicts with information in the Release Notes, the Release Notes take precedence.

ILLUSTRATIONS AND PRODUCT SPECIFICATIONS

The illustrations provided in this document are for demonstration purposes only. Depending on vehicle options, software version and market region, the information displayed on the touchscreen in your vehicle may appear slightly different.

All specifications and descriptions contained in this document are verified to be accurate at the time of printing. However, because continuous improvement is a goal at Tesla, we reserve the right to make product modifications at any time. To communicate any inaccuracies or omissions in this document, please send an email to: ownersmanualfeedback@tesla.com.

SAFETY INFORMATION

You can find safety information in your Model Y Owner's Manual on the touchscreen.

For detailed information about your Model Y, go to the Tesla website for your region, log on to your Tesla account, or sign up to get an account.

If you have any questions or concerns about your Model Y, call Tesla at 0800 005 431.

© 2012-2024 TESLA, INC.

All information in this document and all vehicle software is subject to copyright and other intellectual property rights of Tesla, Inc. and its licensors. This material may not be modified, reproduced or copied, in whole or in part, without the prior written permission of Tesla, Inc. and its licensors. Additional information is available upon request. Shown here are trademarks or registered trademarks of Tesla, Inc. in the United States and other countries:

MODEL 3 MODEL S TESLA TESLA ROADSTER

MODEL Y MODEL X TESLA MOTORS T E S L A





Overview.....	3	About Autopilot.....	106
Exterior.....	3	Autopilot Features.....	108
Interior.....	4	Traffic Light and Stop Sign Control.....	116
Touchscreen.....	5	Autopark.....	123
Interior Electronics.....	9	Summon.....	125
Car Status.....	11	Smart Summon.....	127
Voice Commands.....	14	Limitations and Warnings.....	129
Cameras.....	16		
Opening and Closing.....	18	Active Safety Features.....	134
Keys.....	18	Lane Assist.....	134
Doors.....	22	Collision Avoidance Assist.....	137
Windows.....	24	Speed Assist.....	140
		Cabin Camera.....	141
Storage Areas.....	25	Dashcam, Sentry, and Security.....	142
Rear Trunk.....	25	Safety & Security Settings.....	142
Front Trunk.....	27	Dashcam.....	144
Interior Storage.....	29	Sentry Mode.....	146
		USB Drive Requirements for Recording Videos.....	148
Seating and Safety Restraints.....	31	Climate.....	149
Front and Rear Seats.....	31	Operating Climate Controls.....	149
Seat Belts.....	35	Ventilation.....	154
Child Safety Seats.....	38	Cold Weather Best Practices.....	155
Child Safety Seats.....	48	Hot Weather Best Practices.....	158
Airbags.....	61		
Connectivity.....	64	Navigation and Entertainment.....	159
Mobile App.....	64	Maps and Navigation.....	159
Wi-Fi.....	66	Media.....	165
Bluetooth.....	67	Theater, Arcade, and Toybox.....	167
Phone, Calendar, and Web Conferencing.....	69		
Smart Garage.....	71	Charging and Energy Consumption.....	170
Driving.....	74	Electric Vehicle Components.....	170
Starting and Powering Off.....	74	High Voltage Battery Information.....	171
Steering Wheel.....	75	Charging Instructions.....	173
Mirrors.....	77	Scheduled Precondition and Charge.....	178
Shifting.....	79	Getting Maximum Range.....	180
Lights.....	81		
Wipers and Washers.....	84	Maintenance.....	182
Braking and Stopping.....	85	Software Updates.....	182
Park Assist.....	89	Maintenance Service Intervals.....	183
Vehicle Hold.....	91	Tire Care and Maintenance.....	185
Traction Control.....	92	Cleaning.....	192
Acceleration Modes.....	93	Windshield Wiper Blades, Jets and Fluid.....	196
Track Mode.....	94	Jacking and Lifting.....	198
Driver Profiles.....	96	Parts and Accessories.....	199
Trip Information.....	98	Do It Yourself Maintenance.....	206
Rear Facing Camera(s).....	99		
Pedestrian Warning System.....	100	Specifications.....	207
Towing and Accessories.....	101	Identification Labels.....	207
		Vehicle Loading.....	209
Autopilot.....	106	Dimensions.....	210
		Subsystems.....	212



Contents

Wheels and Tires.....	214
Instructions for Transporters.....	217
Instructions for Transporters.....	217
In Case of Emergency.....	220
Contacting Tesla Roadside Assistance.....	220
Running Out of Range.....	221
Opening the Hood with No Power.....	222
Jump Starting.....	223
Opening Doors with No Power.....	225
Troubleshooting.....	226
Troubleshooting Alerts.....	226
Consumer Information.....	279
About this Owner Information.....	279
Feature Availability Statement.....	280
Disclaimers.....	281
Reporting Safety Defects.....	282
Certification Conformity.....	283
Index.....	285

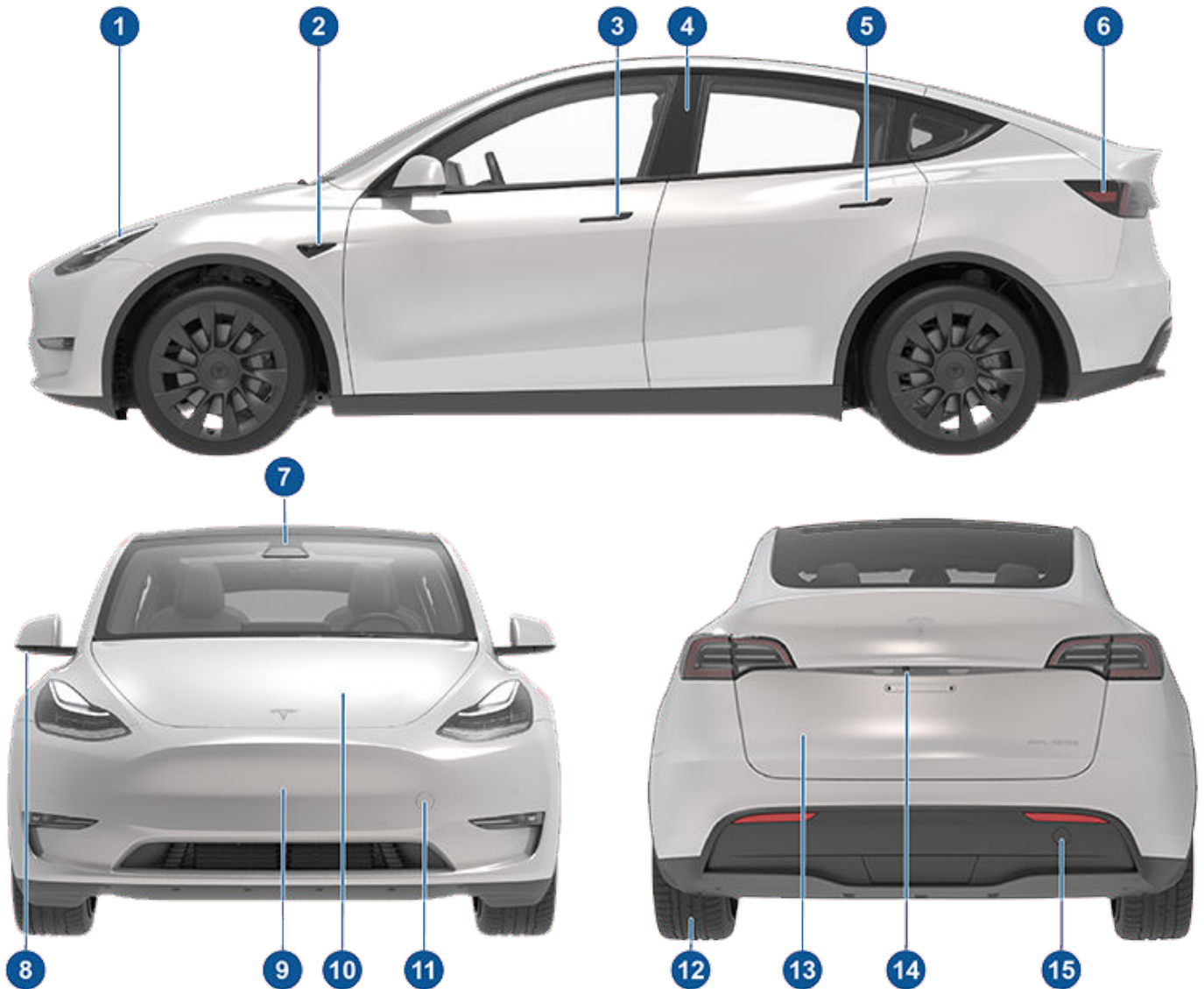

1. Exterior lights ([Lights on page 81](#))
2. Autopilot camera ([Cameras on page 16](#))
3. Front door handle ([Using Exterior Door Handles on page 22](#))
4. Key card sensor ([Keys on page 18](#)), Autopilot camera ([Cameras on page 16](#))
5. Rear door handle ([Using Exterior Door Handles on page 22](#))
6. Charge port ([Charging Instructions on page 173](#))
7. Autopilot cameras ([Cameras on page 16](#))
8. Exterior mirrors ([Mirrors on page 77](#))
9. Radar sensor, if equipped (hidden from view)
10. Hood/front trunk ([Front Trunk on page 27](#))
11. Front tow eye cover ([Instructions for Transporters on page 217](#))
12. Wheels and tires ([Wheels and Tires on page 214](#))
13. Rear trunk ([Rear Trunk on page 25](#))
14. Rear view camera ([Rear Facing Camera\(s\) on page 99](#))
15. Rear tow eye cover ([Instructions for Transporters on page 217](#))



Interior

NOTE: On RHD (Right Hand Drive) vehicles, the controls illustrated throughout the Owner's Manual are arranged similarly, but are mirrored on the right side of the vehicle.

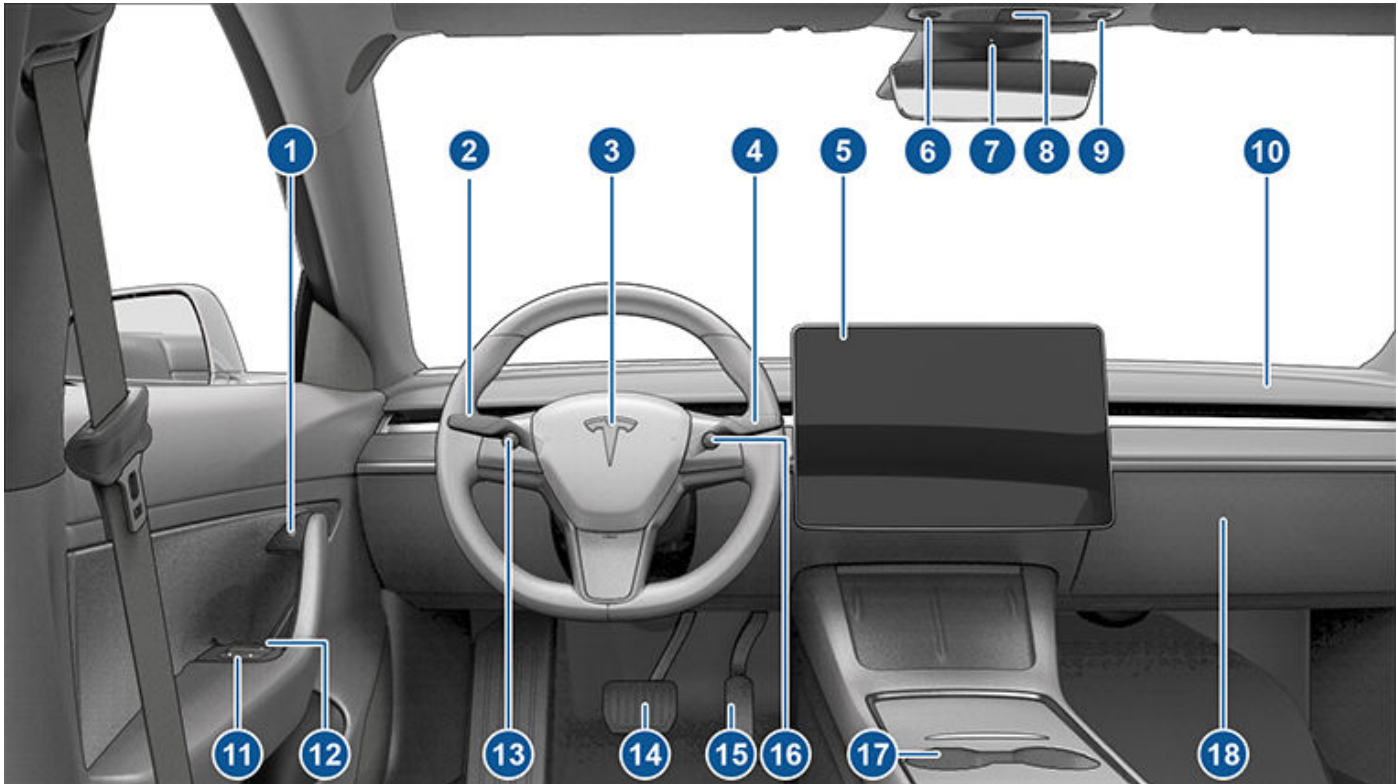

1. Door open button ([Opening Doors from the Interior on page 22](#))
2. Turn signal stalk ([High Beam Headlights on page 82](#)), [Turn Signals on page 83](#), and [Wipers and Washers on page 84](#))
3. Horn ([Horn on page 76](#))
4. Drive stalk ([How to Shift on page 79](#), [Autopilot Features on page 108](#))
5. Touchscreen ([Touchscreen on page 5](#))
6. Driver dome light ([Lights on page 81](#))
7. Cabin camera ([Cabin Camera on page 141](#))
8. Hazard warning flashers ([Hazard Warning Flashers on page 83](#))
9. Passenger dome light ([Lights on page 81](#))
10. Climate control vent (see [Operating Climate Controls on page 149](#))
11. Power window switches ([Windows on page 24](#))
12. Manual door release ([Opening Doors from the Interior on page 22](#))
13. Left scroll button ([Scroll Buttons on page 75](#))
14. Brake pedal ([Braking and Stopping on page 85](#))
15. Accelerator pedal ([Regenerative Braking on page 86](#))
16. Right scroll button ([Scroll Buttons on page 75](#))
17. Center console ([Interior Electronics on page 9](#))
18. Glovebox ([Glovebox on page 29](#))

WARNING: Always pay attention to road and traffic conditions when driving. To minimize driver distraction and ensure the safety of vehicle occupants as well as other road users, avoid using the touchscreen to adjust settings while the vehicle is in motion.

Use the touchscreen to control many features that, in traditional cars, are controlled using physical buttons (for example, adjusting the cabin heating and air conditioning, headlights, etc.). You also use the touchscreen to control media, navigate, use entertainment features, and customize Model Y to suit your preferences. For hands-free access to common touchscreen controls, use voice commands (see [Voice Commands on page 14](#)).

If the touchscreen is unresponsive or demonstrates unusual behavior, you can restart it (see [Restarting the Touchscreen on page 7](#)).

CAUTION: Do not apply a screen protector on the touchscreen. Doing so can result in unintended inputs to the touchscreen (phantom inputs), delayed response or unresponsiveness to touches, electrostatic discharge which can damage the touchscreen, etc. Any damage caused by installing a screen protector is not covered by the warranty.

NOTE: Illustrations are provided to improve conceptual understanding only. Depending on vehicle options, software version, market region and regional and language settings, the details displayed on the screen will differ.

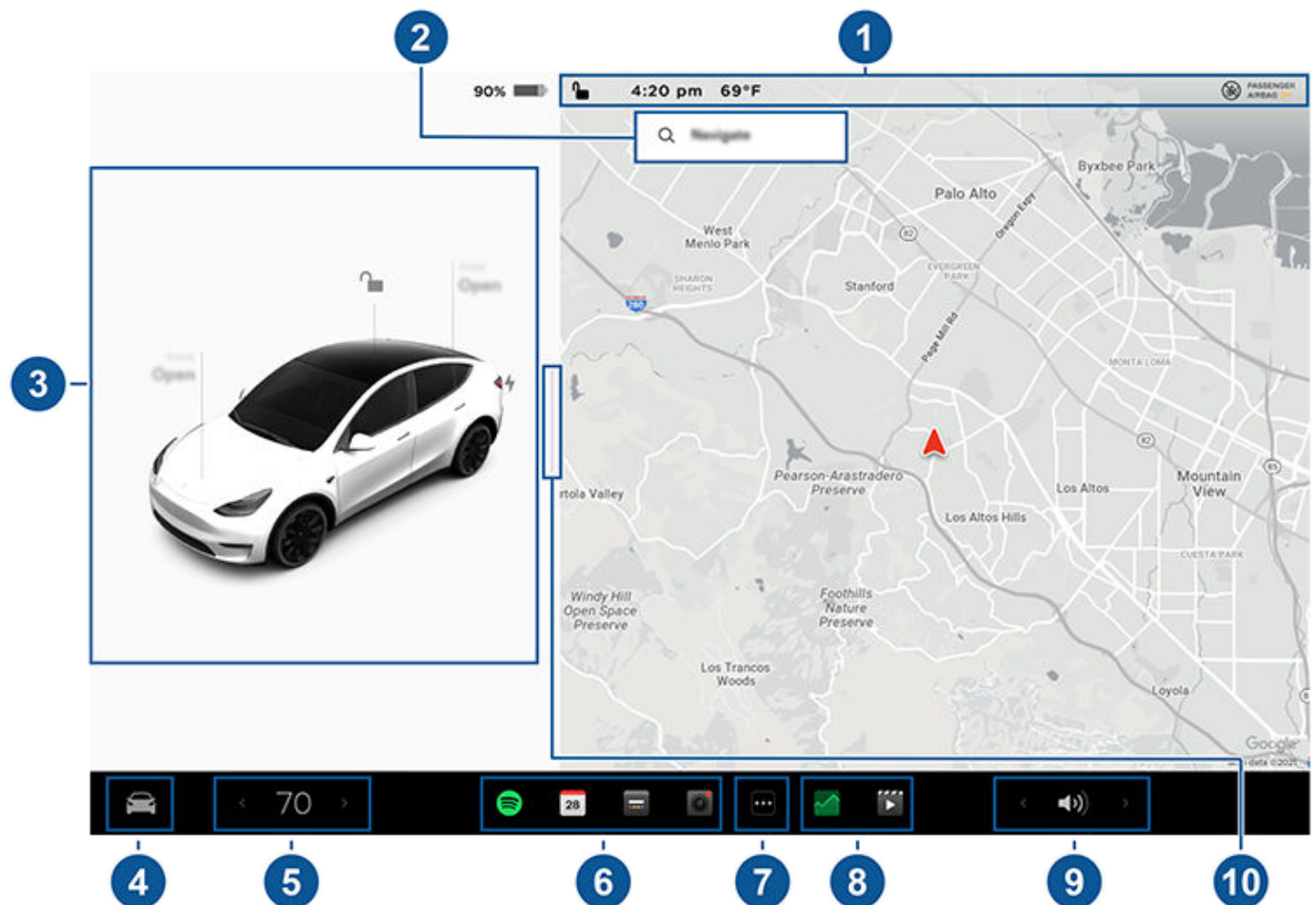

- 1. Status bar:** Find car controls and status in the top bar (see [Top Status Bar Icons on page 6](#)).
- 2. Navigation:** Change the orientation of the map, find or navigate to a destination, and change navigation settings (see [Maps and Navigation on page 159](#)).
- 3. Car status:** This area dynamically displays the current status of Model Y as you drive, park, open doors, turn lights on, etc. Monitor this area when driving as it displays important information such as driving speed and warning messages (see [Car Status on page 11](#)). When the car is in Park, you can open the trunks or charge port door. This area also houses shortcut "cards" for Media, tire pressures, and Trip Information.



Touchscreen

When full self-driving is enabled (if equipped), the car status area displays visualizations of the road and your vehicle's surroundings. You can expand/condense the visualization by dragging the car status area from side to side. Expanding the visualization displays more details about the roadway and its surroundings, including road markings, stop lights, and objects (such as trash cans and poles).

- 4. **Controls:** Control various features and customize Model Y to suit your preferences. The Controls screen appears over the map. Touch an option on the Controls screen to display the various settings and preferences associated with the chosen option.

To search for a specific setting, touch **Search** at the top of the Controls screen. Make changes directly from the result or touch the link to jump to that option in Controls.



When an information icon displays beside a specific setting, touch it to display a popup that provides helpful details about the associated setting.

NOTE: Many vehicle controls, settings, and preferences (such as climate, media, and navigation) can be adjusted hands-free using voice commands (see [Voice Commands on page 14](#)).

NOTE: You can send touchscreen feedback to Tesla by long-pressing this icon.

- 5. **Climate controls (driver):** Use the left and right arrows to decrease/increase cabin temperature. Touch **Split** on the popup to display separate controls for the driver and passenger. Touch the temperature icon to customize climate control settings (see [Operating Climate Controls on page 149](#)). The passenger climate controls display when temperature controls have been **Split** to provide separate controls for the driver and passenger.
- 6. **My Apps:** For one-touch access to frequently used apps and controls, you can choose what displays here. See [Customizing My Apps on page 6](#).
- 7. **App Launcher:** Touch the app launcher to open the app tray. Then touch any app to open it. The app you choose displays on top of the map. To close an app, drag it downward.
- 8. **Recent App(s):** Displays the most recently used app(s). The number of recent apps displayed here depends on how many apps have been added to **My Apps**. If you add the maximum number of apps to **My Apps**, only the most recent app displays.
- 9. **Volume Control:** Controls the volume of media player and phone calls (see [Volume Controls on page 165](#)). The volume of navigation instructions is controlled separately (see [Maps and Navigation on page 159](#)).
- 10. **Full-screen Park view:** (If equipped) Swipe towards the passenger for a full-screen Park view with media and navigation controls.

Customizing My Apps

For one-touch access to commonly used apps and controls, you can customize what displays in the **My Apps** area on the touchscreen's bottom bar:

- 1. Enter customization mode by touching and holding any app or control in the **My Apps** area. If this area is empty, touch the App Launcher.
- 2. Drag any app or control from the app tray onto the **My Apps** area in the bottom bar.

NOTE: Seat heaters selected from the app tray appear next to the temperature, instead of in the My Apps area.

NOTE: When you've added the maximum number of apps or controls to **My Apps**, adding an additional app removes the rightmost app.

NOTE: Remove an app or control from the **My Apps** area by touching and holding, then touching its associated "X".

Top Status Bar Icons



Touch to lock/unlock all doors and trunks.



Displays the local weather conditions. Touch to display more detailed information about the weather and air quality, including chance of rain, humidity, and UV index. Requires premium connectivity.

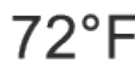

Displays the current temperature. If your vehicle is equipped with premium connectivity, you can also touch to display more detailed information about the weather and air quality, including chance of rain, humidity, and UV index.



Displays on the touchscreen status bar only when Model Y detects that the local Air Quality Index (AQI) value is poor. A poor AQI will have yellow, orange, red, purple, or maroon numbers. Touch to display more detailed information about the weather and air quality, including chance of rain, humidity, and UV index. Requires premium connectivity.

4:20 pm

Your vehicle automatically updates the time. If the time is incorrect, confirm your vehicle has internet and GPS connectivity with the latest software.



Displays on the touchscreen status bar only when Model Y detects a programmed HomeLink within range, and the touchscreen is not already displaying the HomeLink screen or popup. See [Smart Garage on page 71](#).



Displays on the touchscreen status bar only when Model Y is parked. Add, configure (including **Valet Mode** and **Use Easy Entry**), or quickly switch driver profiles. Driver profiles can also be accessed from the top of any Controls screen. See [Driver Profiles on page 96](#).



Available when Model Y is parked, touch to manually enable or disable Sentry Mode for the current drive cycle. To automatically turn Sentry Mode on (or off) every time you leave your vehicle, enable the setting from **Controls > Safety > Sentry Mode**. See [Sentry Mode on page 146](#) for more information.

NOTE: If you turn Sentry Mode on or off from **Controls > Sentry Mode**, the shortcuts on the vehicle's touchscreen and mobile app will only work for the current drive cycle.

NOTE: For some vehicles manufactured after approximately November 1, 2021, the center console USB ports may only support charging devices. Use the USB port inside the glove box for all other functions.



Displays when Model Y is connected to a Wi-Fi network.



Displays when Model Y is connected to a cellular network. Touch this icon for quick access to Wi-Fi settings.



Displays when Model Y cellular connectivity is unavailable. Touch this icon for quick access to Wi-Fi settings.



Status of the front passenger airbag (see [#unique_44 on page](#)).



Appears when your vehicle's GPS location is actively being accessed in the Tesla mobile app by the owner, an added driver, or a third party app you're using. Tap the icon for details. To disable, navigate to **Safety > Allow Mobile Access** on the touchscreen.

Popup Messages and Vehicle Alerts

Popup messages appear at the bottom of the touchscreen. For example, a seat belt reminder appears if a seat belt is unfastened in an occupied seat, an alert appears to notify you of an incoming phone call, a text message appears (when applicable), and voice commands appear when in use. If applicable, touch options from these popup messages (for example, accept/decline a phone call, choose an option from the headlight menu, etc.). To dismiss a popup message, swipe it downward.

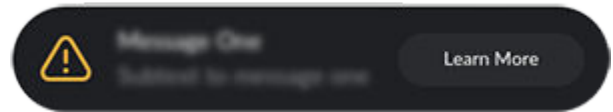

If an alert appears on your vehicle's touchscreen, touch **Learn More** for more details regarding the alert and how it can be resolved. You can view a list of vehicle alerts and notifications by touching the bell icon at the top of **Controls**.

NOTE: Not all alerts provide additional information at this time.

Restarting the Touchscreen

You can restart your touchscreen if it is unresponsive or demonstrates unusual behavior.



WARNING: Only restart the touchscreen while the vehicle is stopped and in Park. The car status display, safety warnings, backup camera, etc. will not be visible during the restart.

1. Shift into Park.
2. Hold down both scroll buttons on the steering wheel until the touchscreen turns black. Pressing the brake pedal while holding down the scroll buttons does not have any impact and is not required.



Touchscreen

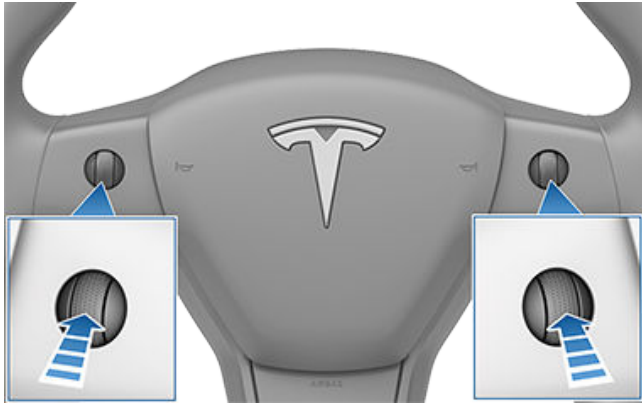

3. After a few seconds, the Tesla logo appears. Wait approximately 30 seconds for the touchscreen to restart. If the touchscreen is still unresponsive or demonstrating unusual behavior after a few minutes, try power cycling the vehicle (if possible). See [Power Cycling the Vehicle on page 74](#).

NOTE: Pressing the scroll buttons only restarts the touchscreen. It does not restart any other vehicle component and does not power Model Y off and on.

Customizing Display and Sound Settings

Touch **Controls** > **Display** to adjust display settings to suit your preferences:

- **Appearance:** Customize the display to be **Dark** or **Light**. When set to **Auto**, the brightness changes automatically based on ambient lighting conditions.
- **Reduce Blue Light:** When enabled, the display automatically adjusts to use warmer colors at night.
- **Brightness:** Drag the slider to manually control the brightness level. If **Display Mode** is set to **Auto**, the touchscreen further adjusts based on both the ambient lighting conditions and your brightness preference. Model Y remembers your chosen brightness preference and adjusts the touchscreen accordingly.
- **Screen Clean Mode:** When enabled, your touchscreen darkens and temporarily disables to facilitate cleaning. Follow the onscreen instructions to exit Screen Clean Mode.
- **Touchscreen Language:** Select the language that the touchscreen displays.
NOTE: Model Y must be in Park to change the language. When you change the language, you experience a brief delay as Model Y shuts down and restarts the touchscreen.
- **Voice Recognition Language:** Choose the language to be used for voice commands.
- **Voice Navigation Language:** Choose the language that the navigation system uses for spoken instructions.

NOTE: For languages that require a download, select the language in the dropdown list to initiate the download (Wi-Fi connection required).

- **Text size:** Select between **Standard** and **Large** to customize the text size on your vehicle's touchscreen.
- **Time:** Choose to display time in either 12 or 24 hour format.
- **Energy Display:** Choose to display remaining energy and charging units as either a percentage of battery energy remaining, or as an estimate of the distance you can drive.
NOTE: When anticipating when you need to charge, use energy estimate as a general guideline only. Many factors have an impact on energy consumption. See [Factors Affecting Energy Consumption on page 180](#).
- **Distance:** Choose to display measurements in metric (kilometers, centimeters, etc.) or imperial (miles, inches, etc.) units.
- **Temperature:** Choose to display temperature using Fahrenheit or Celsius.
- **Tire Pressure:** Choose to display tire pressures using BAR or PSI.

In addition to customizing the display, you can enable Joe Mode to reduce the volume of all chimes that are not related to critical safety issues. Touch **Controls** > **Safety** > **Joe Mode** to enable.

Naming your Vehicle

To further personalize your vehicle, you can name it. Touch **Controls** > **Software** > **Name Your Vehicle** located on the right side of the touchscreen below the image of Model Y. If your vehicle already has a name, touch the existing name to change it. Enter the new name in the popup and touch **Save**. The name of your Model Y also appears in the Tesla mobile app.

Erasing Personal Data with a Factory Reset

When transferring ownership of Model Y, perform a factory reset for security purposes *before removing your vehicle from your account* by touching **Controls** > **Service** > **Factory Reset**. Before erasing data, Model Y verifies your credentials by prompting you to enter the user name and password associated with your Tesla account.

NOTE: Performing a factory reset is only possible when the vehicle is in your account. After the vehicle is removed from your account, you no longer have access to perform a reset of customized settings to the factory defaults and to erase all personal data.



In addition to storage compartments and cup holders (see [Interior Storage on page 29](#)), the Model Y interior supports various electronics such as an RFID transmitter that reads key fobs and key cards (see [Keys on page 18](#)), USB ports, a wireless phone charger, and a 12V power socket.

USB Ports

Model Y has two USB ports located in the front compartment of the center console. These ports can be used to:

- Connect and charge USB devices.
- Play audio files stored on a phone or USB device (see [Playing Media from Devices on page 166](#)).
- Save videos when using features such as Sentry Mode or Dashcam (see [Dashcam on page 144](#) and [Sentry Mode on page 146](#)).

NOTE: The preferred location for saving videos for Sentry Mode or Dashcam is using the USB port located in the glove box. Using this port increases security and minimizes power consumption.

The USB ports can output power up to approximately 15W (which may vary depending on vehicle manufacture date).

NOTE: For some vehicles manufactured after approximately November 1, 2021, the center console USB ports may only support charging devices. Use the USB port inside the glove box for all other functions.

Both ports are USB-C compatible.

See [USB Drive Requirements for Recording Videos on page 148](#) for information about formatting USB flash drives.

Open the front compartment of the center console. The front USB ports are located on the rear wall of the compartment.

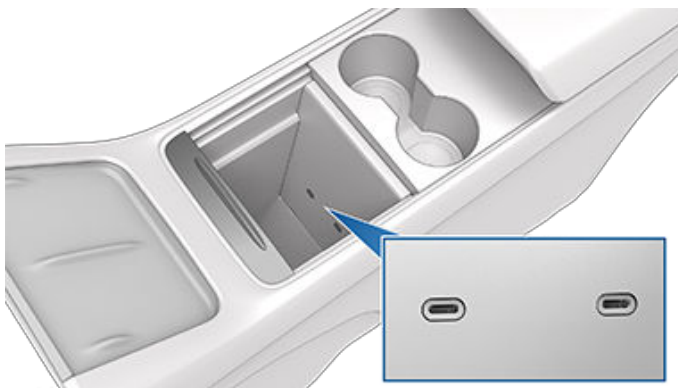

Depending on date of manufacture, some vehicles include a USB port located inside the glovebox. This USB-A port is equipped with a pre-formatted flash drive, ready to save videos when using features such as Sentry Mode and Dashcam. Although not its primary purpose, this port can also communicate with the vehicle and can be used to charge a USB-connected device.

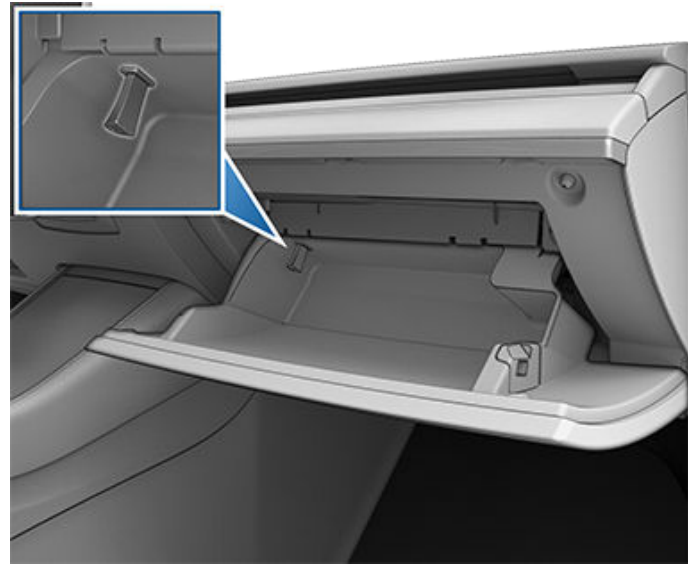

Two additional USB ports are located in the rear of the center console (on vehicles manufactured since approximately June 2020, these ports are USB-C). These ports charge USB-connected devices but do not communicate with the vehicle.



NOTE: Power is available when the vehicle is in use or detects that a user is present. A user is considered present when a person is in the driver seat or interacts with the touchscreen. Leaving an accessory plugged in does not deplete the low voltage battery.

NOTE: Use USB 3.0 compliant cables to connect a device to a USB port. Using non-compliant cables can result in slower charging, potential connection problems or degraded performance.

NOTE: Do not connect multiple devices using a USB hub. This can prevent connected devices from charging or from being recognized by Media Player, Sentry Mode, Dashcam, etc.

Wireless Phone Charger

A wireless phone charger (if equipped), is integrated into the front console to provide up to 15W of power to charge a Qi-enabled phone. Simply place your phone on the charger. Your device may feel warm while charging, but this is a normal effect of inductive charging.



Interior Electronics

When placed on the wireless charger, your phone charges whenever the vehicle is powered on (the touchscreen is on and you are inside the vehicle). Your phone will not charge after exiting the vehicle unless a feature (such as Sentry mode) is enabled and providing power to the USB ports. Model Y will also not charge a phone if the vehicle's Battery is discharged.

NOTE: The phone must be in direct contact with the wireless charger. The wireless phone charger may not work if your phone case is too large or is made of metal. Try removing the phone from its case before placing in the charger.

CAUTION: Before you charge, remove any objects (coins, keys, metal objects, etc.) between the phone and charger, as well as any NFC cards (for example, the vehicle key card, credit cards, or hotel key) placed on or behind the phone (like with integrated phone cases). Damage to NFC cards can occur when you charge the phone without first removing the card.

Low Voltage Power Socket

Your Model Y has a power socket located in the center console's rear compartment.

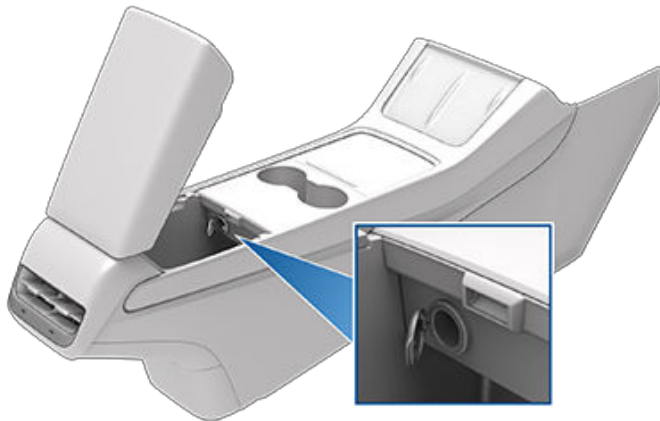

The power socket is suitable for accessories requiring up to 12A continuous draw (16A peak).

NOTE: For vehicles manufactured after approximately November 2021, power inverters plugged into the low voltage power socket must support 16V DC input to function.

An additional low voltage power socket is located on the left side of the rear trunk.



NOTE: Power is available when the vehicle is in use or detects that a user is present. A user is considered present when a person is in the driver seat or interacts with the touchscreen. Leaving an accessory plugged in does not deplete the low voltage battery.

- WARNING:** The power socket and an accessory's connector can become hot.
- WARNING:** To prevent excessive interference with the vehicle's electronics, Tesla recommends that you do not plug any non-Tesla accessories, including power inverters, into the low voltage power socket. However, if you do use a non-Tesla accessory and notice any malfunctions or unexpected behavior, such as indicator lights, alert messages, or excessive heat from the accessory, unplug the accessory from the low voltage power socket immediately.
- CAUTION:** Do not attempt to jump start Model Y using the low voltage power socket. Doing so can result in damage.

Overview

The touchscreen displays the status of Model Y at all times. What you see depends on whether the vehicle is:

- Parked (shown below).
- Driving (see [Driving Status on page 12](#)).
- Charging (see [Charging Status on page 174](#)).

When Model Y is parked, the status area shows the drive mode, estimated range, and an overhead view of the car with buttons you can touch to open the trunks and charge port door. When you press the brake, Model Y powers up and indicator lights flash briefly. Unless an indicator light applies to the current situation (for example, a seat belt is not fastened), it should turn off. If an indicator light fails to turn on or off, contact Tesla.

NOTE: The following image is provided for demonstration purposes only. Depending on vehicle options, software version, and market region, the information displayed may be slightly different.

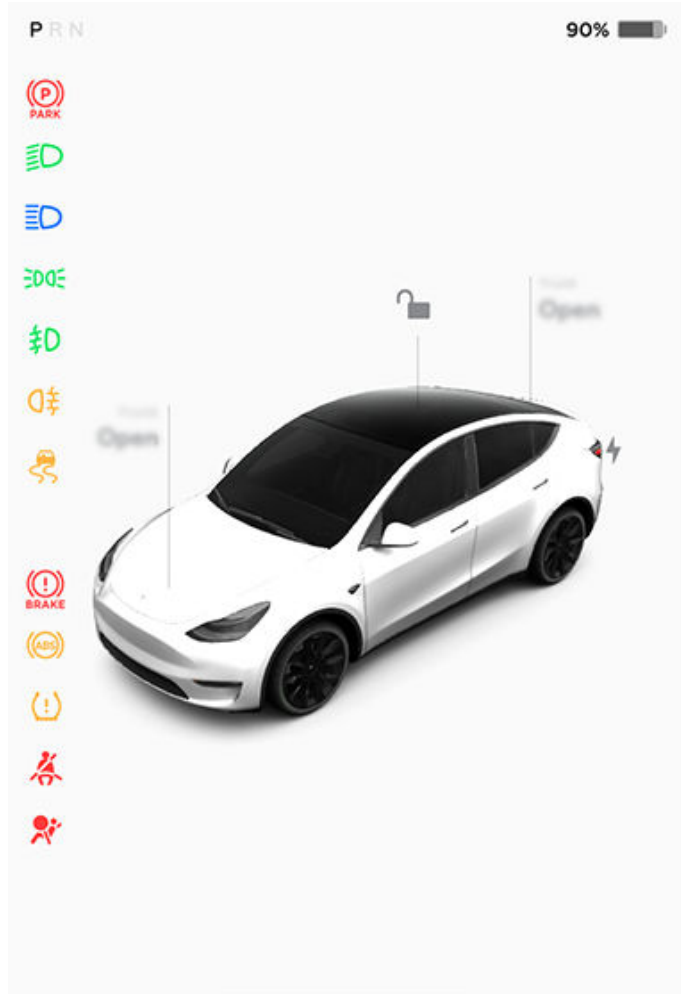

Cards

The bottom of the car status display also shows shortcut "cards" for quick access to Media, tire pressure data, trip information, and more. Swipe the cards to the left or right to customize your cards shortcuts.

Indicator Lights

The following indicator lights illuminate to advise you or alert you of a specific status or condition.



If the touchscreen displays this red brake indicator at any time other than briefly when you first start Model Y, a brake system fault is detected, or the level of the brake fluid is low. Contact Tesla immediately. Apply steady pressure and keep the brake pedal firmly pressed to stop the vehicle when safe to do so.



The touchscreen displays this amber brake indicator if a brake booster fault is detected. Apply steady pressure and keep the brake pedal firmly pressed to stop the vehicle when safe to do so. Hydraulic Boost Compensation will be active (see [Braking and Stopping on page 85](#)).



The ABS indicator briefly flashes amber on the touchscreen when you first start Model Y. If this indicator lights up at any other time, an ABS fault has occurred and the ABS is not operating. Contact Tesla. The braking system remains fully operational and is not affected by an ABS failure. However, braking distances may increase. Drive cautiously and avoid heavy braking.



When you manually apply the parking brake using the touchscreen, the red parking brake indicator lights up on the touchscreen.



If the parking brake experiences an electrical issue, the amber parking brake indicator lights up and a fault message displays on the touchscreen.



Tire pressure warning. The pressure of a tire is out of range. If a fault with the Tire Pressure Monitoring System (TPMS) is detected, the indicator flashes. For a TPMS fault, contact Tesla. See [Tire Care and Maintenance on page 185](#).



A seat belt for an occupied seat is not fastened. See [Seat Belts on page 35](#).



Car Status



Airbag safety. If this indicator does not flash on briefly when Model Y prepares to drive, or if it remains on, contact Tesla immediately. See [Airbag Warning Indicator on page 63](#).



Front fog lights are on, if equipped. See [Lights on page 81](#).



Parking lights are on (side marker lights, tail lights, and license plate lights) . See [Lights on page 81](#).



Low beam headlights are on.



High beam headlights are on and is disabled or currently unavailable.



is enabled and high beams are on. Model Y is ready to turn off the high beams if light is detected. See [High Beam Headlights on page 82](#).



is enabled but high beams are not on because light is detected in front of Model Y. When light is no longer detected, high beams automatically turn back on. See [High Beam Headlights on page 82](#).



This indicator flashes amber when the electronic stability control systems are actively minimizing wheel spin by controlling brake pressure and motor power. See [Traction Control on page 92](#). If this indicator remains on, a fault is detected and you should immediately contact Tesla.



Electronic stability control systems are no longer minimizing wheel spin. On a Rear Wheel Drive vehicle, the traction control system has been turned off, or on an All-Wheel Drive vehicle, Slip Start has been enabled. See [Traction Control on page 92](#).



Vehicle Hold is actively applying the brakes. See [Vehicle Hold on page 91](#).



A door or trunk is open. See [Doors on page 22](#), [Rear Trunk on page 25](#), or [Front Trunk on page 27](#).



A blue snowflake appears when some of the energy stored in the Battery may not be available due to cold weather conditions. During these cold weather conditions, charging rates may also be limited. If Model Y is plugged in, you can heat your Battery by turning on climate control with the mobile app. The snowflake disappears when the Battery is sufficiently warm.



Appears when regenerative braking is limited. See [Regenerative Braking on page 86](#) for more information.



Vehicle power is currently being limited because the energy remaining in the Battery is low, the vehicle's systems are being heated or cooled, or an error is detected by the drive inverter.

See [Popup Messages and Vehicle Alerts on page 7](#) for more information about alert popups on your vehicle's touchscreen.

Driving Status

When Model Y is driving (or ready to drive), the touchscreen shows your current driving status and a real-time visualization of the road as detected by the Autopilot components (see [Cameras on page 16](#)). The visualization automatically zooms in and out to better utilize touchscreen space and inform you when a vehicle is detected in your blind spot.

NOTE: The following illustration is provided for demonstration purposes only. Depending on vehicle options, software version, and market region, the information displayed may be slightly different.

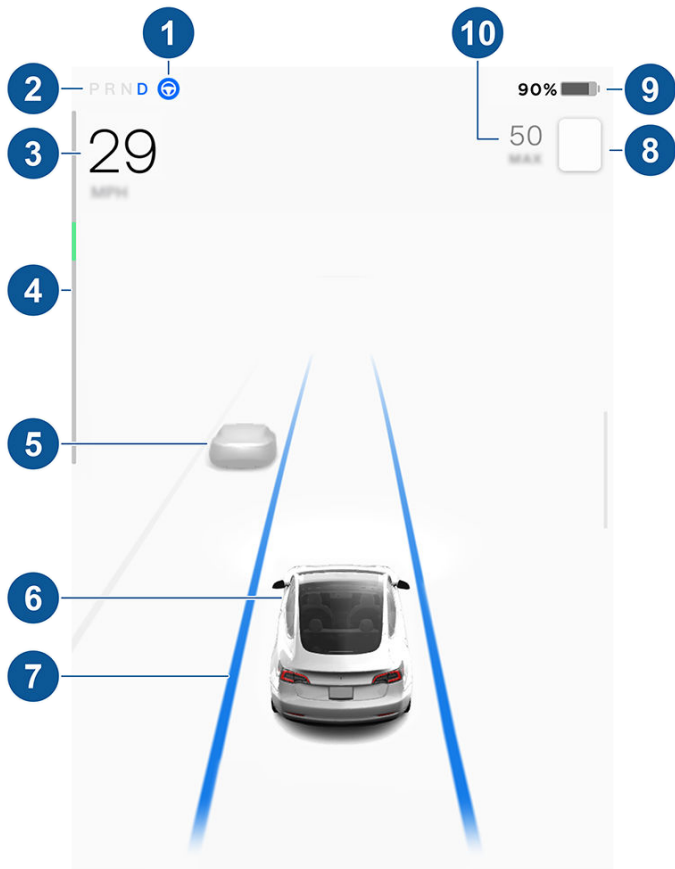

NOTE: To display more details about the roadway and its surroundings, such as road markings, stop lights, objects (such as trash cans and poles), etc., touch **Controls > Autopilot > Full Self-Driving Visualization Preview** (if equipped).

1. When Autosteer is available but you haven't activated it, the icon is gray. When Autosteer is actively steering Model Y, the icon is blue (see [Autosteer on page 109](#)).
2. Currently selected drive mode: Park, Reverse, Neutral, or Drive.
3. Driving speed.
4. The power meter displays real-time power usage (see [Regenerative Braking on page 86](#) for more information). The power meter may display vertically at the top of the driving status screen but the function is the same.
5. Other cars detected on the road (as applicable).
6. Your Model Y. Colored lines radiate from the image of your Model Y as objects are detected (other motorists, guard rails, etc.). The location of the lines correspond to the location of the detected object. The color of the lines (white, yellow, orange, or red) represents the object's proximity to Model Y, with white being the farthest and red being very close and requiring your immediate attention. See [Lane Assist on page 134](#).
7. When Autosteer is active and detecting the driving lane, the lane is highlighted in blue (see [Autosteer on page 109](#)).

NOTE: If Navigate on Autopilot is active, the driving lane displays as a single blue line in front of Model Y (see [Navigate on Autopilot on page 111](#)).

8. The speed limit that is currently being detected by Speed Assist (see [Speed Assist on page 140](#)).

NOTE: A blue outline may appear around the speed limit icon to notify that you are above the speed limit.

NOTE: On roads where the map data determines that a conditional speed limit exists (for example, a speed limit based on time of day or weather conditions), a second speed limit displays. It is the driver's responsibility to determine whether the conditional speed limit is currently in effect and adjust the driving speed accordingly.

NOTE: The icon associated with the detected speed limit reflects the style of speed limit signs used in your market region.

9. Total estimated driving distance (or energy) available. Touch the displayed value to change how available energy is displayed. You can toggle between driving distance and percentage of battery energy remaining. You can also change how energy is displayed by touching **Controls > Display > Energy Display**.

NOTE: When anticipating when you need to charge, use range estimates as a general guideline only.

10. The set cruising speed. When Traffic-Aware Cruise Control is available but you haven't set a cruising speed, the number is gray (see [Traffic-Aware Cruise Control on page 108](#)).

 **WARNING:** Pay attention to important alert messages that display at the bottom of the car status area of the touchscreen. Ignoring these messages can result in serious injury or death.

 **WARNING:** Although the touchscreen shows surrounding traffic, some vehicles may not be displayed. Never rely on the touchscreen to determine if a vehicle is present (for example, in your blind spot). Always use your mirrors and perform shoulder checks.



Voice Commands

NOTE: For your convenience, Tesla allows you to choose from a variety of languages to use for voice commands. To choose a different language, touch **Controls > Display > Voice Recognition Language**.

Use voice commands to easily control settings and preferences without using the touchscreen. Voice commands are designed to understand natural requests. The following is a non-exhaustive list of actions that you can perform with voice commands:

- Adjust climate preferences
- Tweak the windshield wiper speed and frequency
- Control various aspects of your vehicle
- Navigate to a location
- Call a contact
- Interact with apps and settings

To initiate a voice command, press and release the right scroll wheel button on the steering wheel. When a chime sounds, make your request.



Examples of Voice Commands

Here is a list of example voice commands. This is not an exhaustive list. Tesla is constantly working to improve voice commands.

NOTE: Your vehicle must be in Park to enable some voice commands (such as Sentry Mode, Dog Mode, etc.).

Climate Controls

Adjust your climate preferences:

- "Make it cooler"
- "Make it warmer"
- "Turn on/off the driver's seat heater"

- "Cool down the passenger"
- "Direct airflow to my face"
- "Sync climate"
- "Increase/decrease the fan speed"
- "Turn on/off rear defroster"
- "Set the temperature/fan..."
- "Turn on recirculate"

Windshield Wipers

Update the windshield wiper speed and frequency based on changing road and weather conditions:

- "Speed up the wipers"
- "Increase/decrease windshield wiper speed by..."
- "Turn on/off the wipers"

Vehicle Controls

Modify various controls in your vehicle:

- "Sentry Mode on/off"
- "Keep my car safe"
- "Lock/unlock the doors"
- "Turn on Dog Mode"
- "Fold/unfold the mirrors"
- "Open/close charge port"
- "Start/stop charging"
- "Open service settings"
- "Open the glovebox"

Navigation

Search for or navigate to a location:

- "Where is [location]?"
- "Drive to [location]"
- "Navigate to [location]"
- "Show nearby Superchargers"
- "I'm feeling hungry/lucky" (see [Maps and Navigation on page 159](#)).
- "Stop navigation"
- "Mute voice guidance"

If you have defined a navigation address for your home or work locations, you can use a voice command to navigate there by saying "Navigate home" or "Take me to work".



Contacts

To call or text a contact on your Bluetooth-connected phone (see [Phone, Calendar, and Web Conferencing on page 69](#)), say:

- "Call [contact name/phone number]"
- "Text [contact name/phone number]"

Media

Listen to media and adjust your playback preferences:

- "Listen to [song name]"
- "Lower/raise the volume"
- "Skip to next"
- "Pause/play song"
- "Change the source to [media source]"

To improve voice command recognition accuracy, provide multiple cues in your command, such as artist and song.

Apps and Settings

Easily navigate through your apps and settings:

- "Open [Toybox/browser/theater/phone]"
- "Search for..."
- "The screen is too bright"
- "Show me the Owner's Manual"

You can also file a bug report by saying "Report", "Feedback", or "Bug report".

For more information on voice commands, go to <https://www.tesla.com/support/voice-commands>.

NOTE: To support ongoing quality improvements, Tesla captures and processes voice command transcriptions (such as "set the temperature..."). Audio voice recordings are not collected, and transcriptions are not associated with your Tesla account or with your vehicle's identification number. To further protect your privacy, voice commands containing personal data are not captured (such as "Navigate to..." or "Make a call to...").



Cameras

Your Model Y includes the following components that actively monitor the surrounding area:

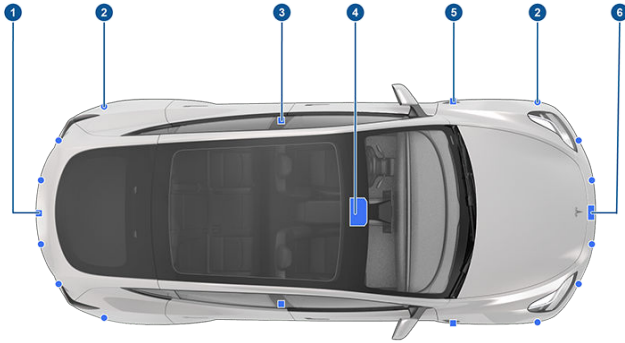

1. A camera is mounted above the rear license plate.
2. Ultrasonic sensors (if equipped) are located in the front and rear bumpers.
3. A camera is mounted in each door pillar.
4. Three cameras are mounted to the windshield above the rear view mirror.
5. A camera is mounted to each front fender.
6. Radar (if equipped) is mounted behind the front bumper.

Model Y is also equipped with high precision electronically-assisted braking and steering systems.

Cabin Camera

Your Model Y may be equipped with a cabin camera located above the rear view mirror. For more information, see [Cabin Camera on page 141](#).



Drive to Calibrate Cameras

Model Y must maneuver with precision when Autopilot features are being used. Therefore, before some features such as Lane Departure Avoidance and Automatic Emergency Braking can be used for the first time or after some types of service repairs, cameras must complete a self-calibration process. For your convenience, the touchscreen displays a progress indicator.

When calibration is complete, Autopilot features, as well as Active Safety features, are available for use. Calibration typically completes after driving 32-40 km, but the distance varies depending on road and environmental conditions. For example, calibration completes quicker when driving on a straight road with multiple lanes (such as a controlled-access highway), with highly-visible lane markings (in the driving lane as well as the adjacent lanes). Contact Tesla only if your Model Y has not completed the calibration process after driving 160 km in the described conditions.

If a camera has shifted from its calibrated position (for example, the camera or windshield was replaced), you must clear the calibration. To do so, touch **Controls** > **Service** > **Camera Calibration** > **Clear Calibration**. When the calibration is cleared, Model Y repeats the calibration process. While this helps re-calibrate the cameras in many cases, **Clear Calibration** may not resolve all camera and sensor concerns.

NOTE: To calibrate, cameras require highly-visible lane markings in both the driving lane and adjacent lanes (at least two lanes over on each side of the vehicle). For best results, drive in the middle lane of a multi-lane highway (ideally with at least five lanes) that has clear lane markings and minimal traffic.

NOTE: If you attempt to use a feature that is not available until the calibration process is complete, the feature is disabled and the touchscreen displays a message.

NOTE: Model Y must repeat the calibration process if the cameras are serviced by Tesla, and in some cases, after a software update.

Keeping Cameras Free of Obstructions

Ensure all cameras are clean and free of obstructions before each drive and before using Autopilot features (see [Cleaning a Camera on page 192](#)). Dirty cameras and sensors (if equipped), as well as environmental conditions such as rain and faded lane markings, can affect Autopilot performance. If a camera is obstructed or blinded, Model Y displays a message on the touchscreen and Autopilot features may not be available. For more information on specific alerts, see [Troubleshooting Alerts on page 226](#).

Condensation can form inside the camera enclosures, especially if you park your vehicle outside in cold or wet conditions. The touchscreen may display an alert stating that a camera is blocked and that some or all Autopilot features may be temporarily restricted until the camera vision is clear. To proactively dry the condensation, precondition the cabin

by setting it to a warm temperature, turning the windshield defroster on, and directing the front air vents toward the door pillars (see [Mobile App on page 64](#)).

Types of Keys

Model Y supports the following types of keys:

- **Phone key** – You can set up your personal phone as a "phone key" that communicates with Model Y using Bluetooth. A phone key supports automatic locking and unlocking.
- **Key card** – Tesla provides two key cards that communicate with Model Y using short range radio-frequency identification (RFID) signals. Unlike the phone key and key fobs, the key card does not support automatic locking and unlocking. In situations where your phone key has a dead battery, or is lost or stolen, use your key card to unlock, drive, and lock Model Y.
- **Key fob** – The key fob (if equipped) allows you to press buttons to open the front and rear trunks, and unlock, lock, and drive Model Y. The key fob also supports automatic locking and unlocking, if available in your region (see [Walk-Away Door Lock on page 22](#)) and can be used as a backup to your phone key.

Model Y supports a total of 19 keys, which can include phone keys, key cards, and up to four key fobs.

 **CAUTION:** Remember to bring a key with you when you drive. Although you can drive Model Y away from its key, you will be unable to power it back on after it powers off.

Phone Key

 **CAUTION:** Do not leave your paired phone in your vehicle (for example, if you are hiking or at the beach). If you must leave your phone in the vehicle, disable Bluetooth and/or turn the phone off.

Using your phone as a key is a convenient way to access your Model Y. As you approach, your phone's Bluetooth signal is detected and the doors unlock when you pull a door handle. Likewise, when you exit and walk away with the phone key, doors automatically lock (provided the **Walk-Away Door Lock** feature is turned on; see [Walk-Away Door Lock on page 22](#)).

Before you can use a phone to access Model Y, follow these steps to authenticate it (see [Pairing a New Phone Key on page 20](#)).

Once a phone has been authenticated, it no longer requires an internet connection to be used as a phone key for Model Y. However, to use the phone hands-free, access your phone's contacts, play media from it, etc., you must also pair it and connect it as a Bluetooth device (see [Bluetooth on page 67](#)).

To view a list of keys that can currently access Model Y, or to remove a phone key, touch **Controls > Locks** (see [Managing Keys on page 20](#)).

Model Y can connect to three phone keys simultaneously. Therefore, if more than three phone keys are detected and you want to authenticate or pair a different phone, move the other connected phone key(s) out of range or turn off its Bluetooth setting.

Some smartphones with NFC capability can be used to lock/unlock your vehicle, just like using a key card. Ensure the Tesla mobile app is correctly paired to your vehicle and enable the NFC function on your phone. Once enabled, simply hold the phone to the driver's side door pillar to lock or unlock the door. Refer to your smartphone's instructions for specific information on how to do this.

Key Card

Tesla provides you with two Model Y key cards, designed to fit in your wallet.

To use a key card to unlock or lock Model Y, position the card as shown and tap it against the card reader located just below the Autopilot camera on the driver's side door pillar. When Model Y detects the key card, the exterior lights flash, the mirrors unfold or fold (if Fold Mirrors is on), the horn sounds (if Lock Confirmation Sound is on), and the doors unlock or lock.

NOTE: You may need to physically touch the center console or driver's side door pillar with the key card, and you may need to hold it against the transmitter for one or two seconds.



Once inside, power up Model Y by pressing the brake pedal within two minutes of scanning the key card (see [#unique_97 on page](#)). If you wait longer than two minutes, you must re-authenticate by placing the key card near the card reader located behind the cup holders on the center console. When your key card is detected, your two minute authentication period restarts.



NOTE: If enabled, Walk-Away Door Lock (see [Walk-Away Door Lock on page 22](#)) operates only when you walk away using a phone key or key fob. When you walk away carrying your key card, Model Y does not automatically unlock/lock.

CAUTION: Always carry your key card with you in your purse or wallet to use as a backup in case your authenticated phone has a dead battery, or is lost or stolen.

Key Fob

If you have purchased the key fob accessory, you can quickly familiarize yourself with this key by thinking of it as a miniature version of Model Y, with the Tesla badge representing the front. The key has three buttons that feel like softer areas on the surface.



1. Front trunk - Double-click to unlatch the front trunk.
2. Lock/Unlock All - Single-click to lock doors and trunks (all doors and trunks must be closed). Double-click to unlock doors and trunks.

3. Rear trunk - Double-click to unlatch the rear trunk. Hold down for one to two seconds to open the charge port door.

Once inside, power up Model Y by pressing the brake pedal within two minutes of pressing the unlock button on the key fob (see [Starting and Powering Off on page 74](#)). If you wait longer than two minutes, you must press the unlock button again, or place the key fob near the card reader located behind the cup holders on the center console. When your key fob is detected, the two minute authentication period restarts.

When approaching or leaving Model Y carrying the key fob, you do not need to point the key fob at Model Y as you press a button, but you must be within operating range.

Radio equipment on a similar frequency can affect the key. If this happens, move the key at least 30 cm away from other electronic devices (phones, laptops, etc.).

In the event that the key fob's battery is dead, you can still use it to drive the vehicle by scanning the key fob on the card reader located on the driver's side door pillar (like the key card).

Instructions for changing the battery are provided in [Replacing the Key Fob Battery on page 20](#).

NOTE: You can use the same key fob with multiple Model Y vehicles provided you authenticate it (see [Managing Keys on page 20](#)). However, key fob works with only one Model Y at a time. Therefore, to use a key fob for a different Model Y, touch its flat side against the card reader on the driver's side door pillar.

NOTE: Model Y supports up to four different key fobs.

CAUTION: Protect the key from impact, high temperatures, and damage from liquids. Avoid contact with solvents, waxes, and abrasive cleaners.

Passive Locking and Unlocking

Locking and unlocking Model Y with your key fob is conveniently hands-free. Although you must be carrying a paired key fob, there is no need to use it. Model Y has sensors around the vehicle that can recognize the presence of a key fob within a range of approximately two meters. Therefore, you can keep your key fob in your pocket or purse and simply pull on the door handle to unlock. When carrying your key fob with you, you can also open the trunk without having to use the key by pressing the liftgate's exterior door handle. If **Walk-Away Door Lock** is enabled, Model Y automatically locks when you exit and the key fob is no longer in range (see [Walk-Away Door Lock on page 22](#)). Passive locking and unlocking is automatically enabled when you pair your key fob to Model Y.

Although you can use the same key fob with multiple vehicles, it can only be paired to one vehicle at a time. To activate a paired key fob to a different vehicle, touch the flat side onto the driver's side door pillar and click any button on the key fob to confirm.



NOTE: For increased security, passive locking and unlocking disables after being stationary for five minutes while within vehicle range when the vehicle is not in use (for example, you are standing outside your vehicle). In this situation, you must shake or press a button on the key fob to re-enable passive locking and unlocking.

Replacing the Key Fob Battery

Under normal use, the accessory key fob has a battery that lasts for up to one year, depending on key fob version and selected vehicle settings. When the battery is low, a message displays on the touchscreen.

To replace the key fob battery:

1. With the key fob placed button side down on a soft surface, release the bottom cover, using a small flat-bladed tool.



2. Remove the battery by lifting it away from the retaining clips.



3. While avoiding touching the battery's flat surfaces, insert the new battery (type CR2032) with the '+' side facing up.

NOTE: Wipe the battery clean before fitting and avoid touching the battery's flat surfaces. Finger marks on the flat surfaces of the battery can reduce battery life.

NOTE: CR2032 batteries can be purchased from any retailer that sells batteries.

4. Holding the bottom cover at an angle, align the tabs on the cover with the corresponding slots on the key fob, then press the cover firmly onto the key fob until it snaps into place.
5. Test that the key fob works by unlocking and locking Model Y.

⚠ WARNING: Key fob batteries contain a chemical burn hazard and should not be ingested. The key fob contains a coin cell battery. If the coin cell battery is swallowed, it can cause severe internal burns within two hours and can lead to death. Keep new and used batteries away from children. If the battery compartment does not close securely, stop using the product and keep it away from children. If you think batteries might have been swallowed or placed inside any part of the body, seek immediate medical attention.

Managing Keys

To display a list of all keys that can access your Model Y, touch **Controls > Locks**. An icon displays next to each key to indicate whether the key is a phone key, key card, or key fob. Use this list to manage keys that have access to your Model Y.

Model Y supports up to 19 keys. When you reach this limit, you must delete a key before adding a new one.

NOTE: You can use the same key for more than one Model Y. This prevents you from having to deal with multiple keys when you switch vehicles. If you customize the name of an authenticated key card or key fob on one Model Y (by touching the pencil icon), any other Model Y to which the key card or key fob is authenticated also displays the changed name.

NOTE: If you are leasing your vehicle, contact your leasing company to add or remove keys.

Pairing a New Phone Key

To set up your smartphone as a key:

1. Download the Tesla mobile app to your phone.
2. Log into the Tesla mobile app using your Tesla account username and password.

NOTE: You must remain logged in to your Tesla account to use your phone to access Model Y.

NOTE: If multiple vehicles are linked to your Tesla account, you must ensure that the vehicle you want the mobile app to access is currently selected on the mobile app.

3. Ensure:
 - Your phone's general Bluetooth settings are enabled.
 - Bluetooth is enabled within your phone's settings for the Tesla mobile app. For example, on your phone, navigate to Settings, choose the Tesla mobile app, and ensure the Bluetooth setting is turned on.
 - Access to your location is enabled. Open the Tesla mobile app in your phone's settings and select **Location > Always**. For the best experience, keep the mobile app running in the background.
 - Allow Mobile Access is enabled on the vehicle touchscreen (**Controls > Safety > Allow Mobile Access**).

NOTE: Model Y communicates with your phone using Bluetooth. Keep in mind that your phone must have enough battery power to run Bluetooth and that many phones disable Bluetooth when the battery is low.

4. While inside or near the vehicle, open the Tesla mobile app and touch **Set Up Phone Key** on the main screen, or navigate to **Security > Set Up Phone Key**. Follow the prompts on the mobile app and vehicle touchscreen to set up your phone key.

Adding Keys from the Touchscreen

If you have a key card or key fob that is already paired with your vehicle, you can pair a new key using the touchscreen.

1. On the touchscreen, touch **Controls > Locks > Keys > Add Key**.
2. Scan your new key card or key fob on the card reader located behind the cup holders on the top of the center console. After the new key card or key fob is recognized, remove it from the card reader.

NOTE: When adding a key fob, ensure it is at room temperature. Pairing a key fob that is very cold can be unsuccessful.
3. Scan a key card or key fob that has already been paired to the vehicle to confirm new key pairing.
4. When complete, the key list includes the new key. Touch the associated pencil icon to customize the name of the key.

Adding Keys from the Mobile App

In the event that you don't have a working key card or key fob, you can add a new key using the Tesla mobile app.

NOTE: Only the owner of the vehicle is able to pair a new key using the mobile app.

NOTE: Pairing a key with the mobile app is supported with version 4.29.0 of the Tesla mobile app on vehicles with software versions 2022.40 or higher.

1. While inside or near the vehicle, open the Tesla mobile app on your smartphone.
2. In the mobile app, touch **Security & Drivers**, then touch **Add Key Card**.
3. Scan your new key card or key fob on the card reader located behind the cup holders on the top of the center console.

NOTE: When adding a key fob, ensure it is at room temperature. Pairing a key fob that is very cold can be unsuccessful.
4. When the key is paired successfully, the mobile app shows a confirmation message. Touch **Done** in the mobile app and remove the key card or key fob from the card reader.
5. When complete, the key list on the touchscreen includes the new key. Touch the associated pencil icon to customize the name of the key.

Removing Keys

When you no longer want a key to access Model Y (for example, you lost your phone or key card, etc.), follow these steps to remove it.

1. On the touchscreen, touch **Controls > Locks**.
2. In the key list, find the key that you would like to delete and touch its associated trash icon.
3. When prompted, scan an authenticated key on the card reader to confirm the deletion. When complete, the key list no longer includes the deleted key.

NOTE: Model Y requires at least one authenticated key card or key fob at all times. If only one key card remains on the key list, you cannot delete it.

Replacing Key cards

If you lose a key card, you can purchase replacement ones on the Tesla Shop. When ready to pair, simply follow the steps in [Managing Keys on page 20](#). Remember to remove your old key cards from **Controls > Locks > Keys** for security purposes.



Using Exterior Door Handles

Use your thumb to push the wide part of the door handle. The handle pivots toward you, and you can open the door by pulling the handle or pulling the edge of the door.



The handle retracts automatically.



When a door or trunk is open, the touchscreen displays the Door Open indicator light.

NOTE: See [Cold Weather Best Practices on page 155](#) to ensure door handles function properly in cold weather.

WARNING: While using the door handle, take care to avoid allowing fingers, jewelry, acrylic nails, etc. from being pinched by the door or door handle mechanism. Failure to do so may result in damage or injury.

Opening Doors from the Interior

Model Y doors are electrically powered. To open a door while sitting inside, press the button located at the top of the interior door handle while pushing the door open.

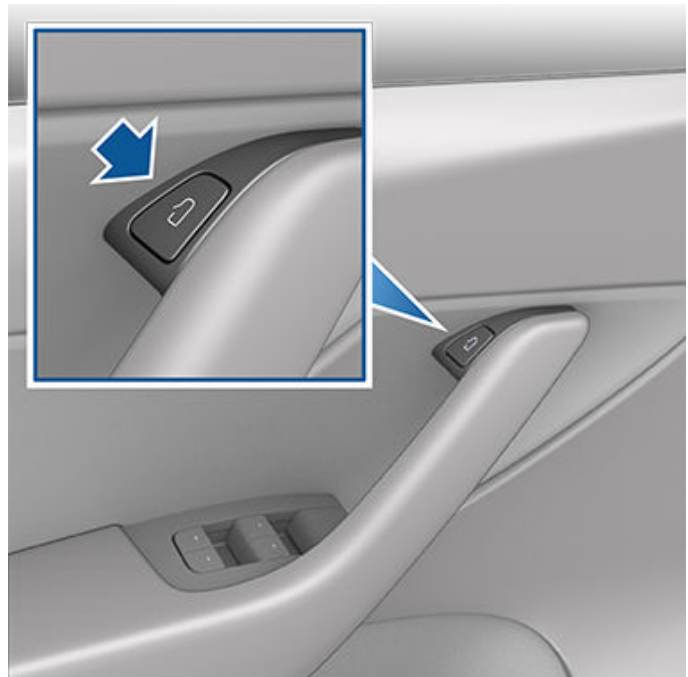

NOTE: To prevent children from opening the rear doors, turn on child locks (see [Child Locks on page 23](#)).

NOTE: In the unlikely event that Model Y has no low voltage power, you will be unable to open the doors with the button on the top of the door handle. See [Opening Doors with No Power on page 225](#) for more information.

Interior Locking and Unlocking

While sitting inside Model Y, you can lock and unlock all doors and trunks by touching the lock icon on the touchscreen.



The icon changes to indicate whether doors are locked or unlocked.

You can also unlock the doors by pressing the Park button on the end of the drive stalk a second time. Pressing this button once engages Park and pressing it again unlocks the doors.

Walk-Away Door Lock

Doors and trunks can automatically lock when you walk away carrying your phone key or paired key fob. To turn this feature on or off, touch **Controls > Locks > Walk-Away Door Lock**.

When the doors lock, the exterior lights flash once and the mirrors fold (if **Fold Mirrors** is on). To also hear a confirmation sound when Model Y locks, touch **Controls > Locks > Lock Confirmation Sound**.

NOTE: Touch **Toybox > Boombox > Lock Sound** to customize the lock sound when the vehicle is locked from the outside (Pedestrian Warning System required).

Model Y does not automatically lock if:

- You check the **Exclude Home** checkbox and Model Y is parked at the location you have designated as Home. For details on how to designate a location as Home, see [Home, Work, and Favorite Destinations on page 161](#).
- A phone key or paired key fob is detected inside Model Y.
- A door or trunk is not fully closed.
- The phone key's Bluetooth setting is turned off.
- If Model Y detects an authenticated key for several minutes after you exit the vehicle and close all doors, Walk-Away Lock disables and doors do not lock when you walk away. In this case, you must manually lock your vehicle until after your next drive.
- The driver does not use the driver door to get out of the vehicle.

NOTE: It is ultimately your responsibility to ensure your vehicle is locked, even when Walk-Away Door Lock is enabled.

Drive Away Locking

Model Y automatically locks all doors (including the trunks) when your driving speed exceeds 8 km/h.

Driver Door Unlock Mode

Enabling **Controls > Locks > Driver Door Unlock Mode** only unlocks the driver door when you first unlock Model Y. The driver door unlocks only if a key is present on the driver side of the vehicle and not the passenger side. To unlock the remaining doors, long press the button located at the top of the interior driver door handle, use the touchscreen, mobile app, or press the key fob a second time.

Car Left Open Notifications

To receive a mobile notification if a door, trunk and/or window is left open or if Model Y is left unlocked unexpectedly, touch **Controls > Locks > Car Left Open Notifications**.

Child Locks

Model Y has child locks on the rear doors to prevent them from being opened using the interior release buttons. On the touchscreen, touch **Controls > Locks > Child Lock**. You can choose **Both** to engage the child lock on both rear doors, or you can choose **Left** or **Right** to engage it on just a specific door.



WARNING: It is recommended that you turn on child locks when children are seated in the rear seats.

Unlock on Park

When you stop Model Y and engage Park, you can choose to unlock all doors. To turn this feature on or off, touch **Controls > Locks > Unlock on Park**.

NOTE: If set to **OFF**, you can unlock all doors by pressing the Park button a second time after engaging Park.



Windows

Opening and Closing

NOTE: It is your responsibility to ensure windows are closed after locking the vehicle.

Press down on a switch to lower the associated window. Window switches operate at two levels:

- To lower a window fully, press the switch all the way down and immediately release.
- To lower a window partially, press the switch gently and release when the window is where you want it.

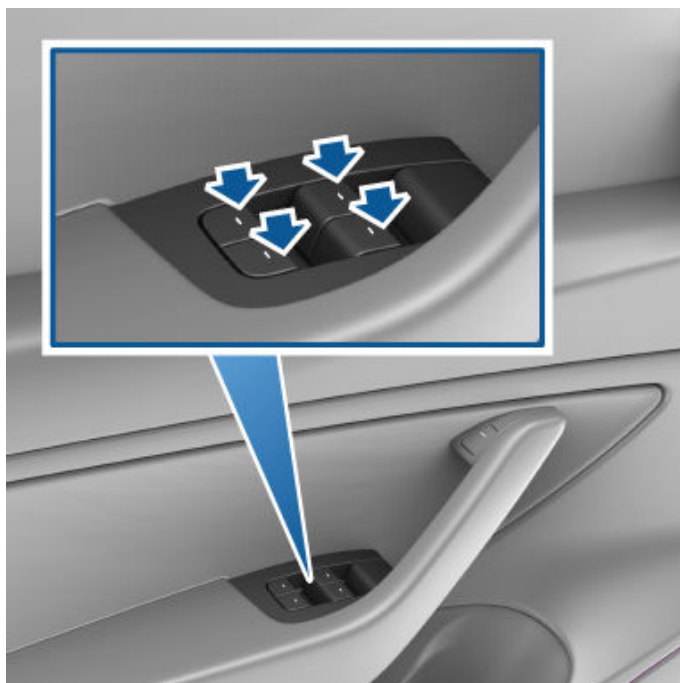

Similarly, pull a switch to raise the associated window:

- To raise a window fully, pull the switch all the way up and immediately release.
- To raise a window partially, pull the switch gently and release when the window is where you want it.

If a window is left open unintentionally, Model Y can send a notification to the mobile app (touch **Controls** > **Locks** > **Car Left Open Notification**, then choose **Doors & Windows**).

You can also enable **Close Windows on Lock** by touching **Controls** > **Locks** > **Close Windows on Lock**. When enabled, your vehicle automatically closes the windows when Model Y locks.

NOTE: See [Cold Weather Best Practices on page 155](#) for information on preparing windows for cold weather.

CAUTION: To avoid damage, windows automatically lower slightly when you open or close a door. If you manually raise a window when the door is open, ensure it is slightly lowered before closing the door.

WARNING: Before closing a window, it is the driver's responsibility to ensure that all occupants, especially children, do not have any body parts extended through the window's opening. Failure to do so can cause serious injury.

Locking Rear Windows

To prevent passengers from using the rear window switches, touch **Controls** > **Locks** > **Window Lock**. To unlock the rear windows, touch **Window Lock** again.

WARNING: To ensure safety, it is recommended that you lock the rear window switches whenever children are seated in the rear seats.

WARNING: Never leave children unattended in Model Y.

Calibrating Windows

In the unlikely event that a window behaves unexpectedly (touches the bright molding, fails to open or close properly, goes down more than normal when the door opens, etc.), you can calibrate it to potentially fix the issue.

To calibrate a window:

1. Close the door with the affected window.
2. Sit in the driver's seat and close the driver door.
3. Using the window's switch on the driver's door, **raise** the affected window until it stalls.
4. Using the window's switch on the driver's door, **lower** the affected window until it stalls.
5. Repeat step 3 and **raise** the affected window until it stalls.

The window should now be calibrated. If the issue continues after attempting the calibration procedure a couple times, contact Tesla.

UV Index Rating

The roof, windshields, and windows in Model Y are excellent at protecting you from UV (ultraviolet) rays. The glass components score less than 2 on the UV Index scale. Review your region's UV Index specifications for more information. You are still responsible for taking the necessary precautions for sun protection.

Opening

To open the rear trunk, ensure Model Y is in Park, then do one of the following:

- Touch the associated **Open** button on the touchscreen.
- Double-click the rear trunk button on the key fob.
- Touch the rear trunk button on the mobile app.
- Press the switch located under the liftgate's exterior handle (a valid key must be detected).

CAUTION: Before opening the liftgate in an enclosed area (such as a garage), ensure the opening height of the liftgate is properly adjusted to avoid low-hanging ceilings or objects (see [Adjusting Liftgate Opening Height](#) on page 25).

Model Y must be unlocked or detect a key before you can use the switch to open the liftgate.



When a door or trunk is open, the touchscreen displays the Door Open indicator light. The image of your Model Y on the touchscreen also displays the open trunk.

To stop a liftgate while it is moving, single-click the rear trunk button on the key fob. Then, when you double-click the rear trunk button, it moves again, but in the opposite direction (provided it was not almost entirely open or closed when you stopped it). For example, if you single-click to stop the liftgate while opening, when you double-click, it closes.

NOTE: In emergency situations, you can override an open or close command by grasping the liftgate to stop it in place.

WARNING: Before opening or closing the liftgate, check the surrounding area (for people and objects). You must proactively monitor the liftgate to ensure that it does not come into contact with a person or object. Failure to do so may result in damage or injury.

A low voltage power socket is located on the left side of the rear trunk.



Adjusting Liftgate Opening Height

You can adjust the opening height of the liftgate to make it easier to reach or to avoid low-hanging ceilings or objects (for example, a garage door or light):

1. Open the trunk, then manually lower or raise the liftgate to the desired opening height.
2. Press and hold the button on the underside of the liftgate for three seconds until you hear a confirmation chime.



3. Confirm that you have set it to the desired height by closing the liftgate, then reopening it.

CAUTION: Depending on configuration (such as suspension height or wheel selection), your vehicle's liftgate can open up to approximately 2.3 meters high. Adjust the liftgate height to prevent it from coming into contact with low ceilings or other objects.

Closing

To close the liftgate, do one of the following:

- Touch the associated **Close** button on the touchscreen.
- Double-click the rear trunk button on the key fob.
- Press the switch located on the underside of the liftgate

If the liftgate senses an obstruction when closing, it stops moving and chimes two times. Remove the obstruction and try closing it again.

Accessing the Cargo Area

To access the cargo area inside the rear trunk, pull up the strap at the rear of the cargo cover. You can then fold the cargo cover forward or remove it from Model Y.

Secure all cargo before moving Model Y, and place heavy cargo in the lower trunk compartment.



Rear Trunk Load Limits

Distribute the weight of cargo as evenly as possible between the front and rear trunks.

 **CAUTION:** Never load more than 40 kg in the lower compartment of the rear trunk or more than 130 kg on the upper compartment (above the lower compartment cover). Doing so can cause damage.

 **WARNING:** When loading cargo, always consider the vehicle's Technically Permissible Maximum Laden Mass (TPMLM) (see [Specifications on page 207](#)). The TPMLM is the maximum allowable total mass of the vehicle including all passengers, fluids, and cargo.

Opening

To open the front trunk, ensure Model Y is in Park, and then do one of the following before pulling the hood open:

- Touch the associated **Open** icon on the touchscreen.
- Double-click the front trunk button on the key fob.
- Touch the front trunk button in the mobile app.



When a door or trunk/liftgate is open, the touchscreen displays the Door Open indicator light. The image of your Model Y on the touchscreen also displays the open front trunk.

WARNING: Before opening or closing the hood, it is important to check that the area around the hood is free of obstacles (people and objects). Failure to do so may result in damage or serious injury.

Closing

The Model Y hood is not heavy enough to latch under its own weight and applying pressure on the front edge or center of the hood can cause damage.

To properly close the hood:

1. Lower the hood until the striker touches the latches.
2. Place both hands on the front of the hood in the areas shown (in green), then press down firmly to engage the latches.
3. Carefully try to lift the front edge of the hood to ensure that it is fully closed.

CAUTION: To prevent damage:

- Apply pressure only to the green areas shown. Applying pressure to the red areas can cause damage.
- Do not close the hood with one hand. Doing so applies concentrated force in one area and can result in a dent or crease.
- Do not apply pressure to the front edge of the hood. Doing so can crease the edge.
- Do not slam or drop the hood.
- To avoid scratches, don't have anything in your hands (keys). Jewelry can also cause scratches.

WARNING: Before driving, you must ensure that the hood is securely latched in the fully closed position by carefully trying to lift the front edge of the hood upward and confirming there is no movement. It is the driver's responsibility to ensure that the front trunk is properly closed before driving.

If the front trunk is left open when you attempt to shift out of Park, a notification requiring you to confirm your intent to drive appears on the touchscreen. If you choose to keep the front trunk open while driving, your vehicle speed is limited.

The front trunk locks when:

- You lock Model Y using the touchscreen, key or mobile app.
- You leave Model Y carrying your key (if [Walk-Away Door Lock](#) on page 22 is turned on).
- Valet mode is active (see [Valet Mode](#) on page 97).



Front Trunk Load Limit

Distribute the weight of cargo as evenly as possible between the front and rear trunks.

CAUTION: Never load more than 50 kg in the front trunk. Doing so can cause damage.

WARNING: When loading cargo, always consider the vehicle's Technically Permissible Maximum Laden Mass (TPMLM) (see [Specifications on page 207](#)). The TPMLM is the maximum allowable total mass of the vehicle including all passengers, fluids, and cargo.

Interior Emergency Release

An illuminated interior release button inside the front trunk allows a person locked inside to get out.



Press the interior release button to unlatch the front trunk, then push up on the hood.

NOTE: The interior release button glows following a brief exposure to ambient light.

WARNING: People should never climb inside the front trunk. Never shut the front trunk when a person is inside.

WARNING: Care should be taken to ensure that objects inside the front trunk do not bump against the release button, causing the hood to accidentally open.



Center Console

In addition to housing an RFID transmitter that reads key fobs and key cards (see [Keys on page 18](#)), the center console includes cup holders, two storage compartments, and a wireless phone charger (see [Interior Electronics on page 9](#)).

To open the main storage compartment, pull its cover upward. Open the front storage compartment by sliding its cover forward.

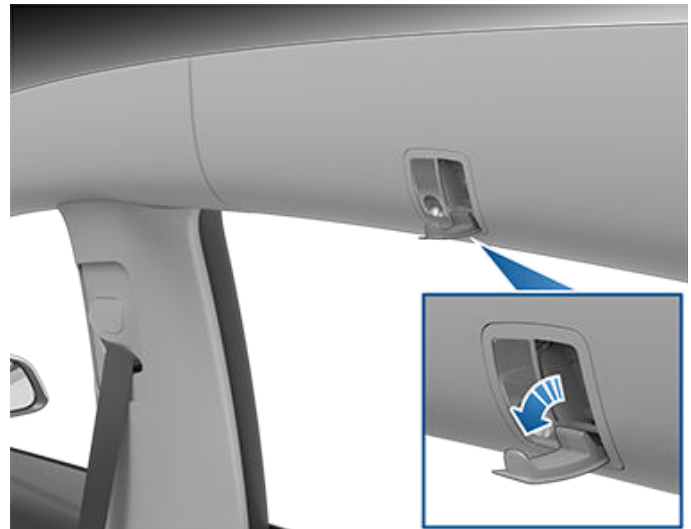
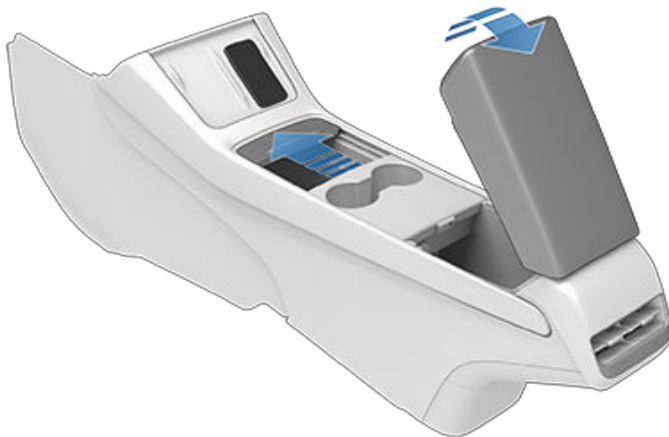

Glovebox

To open the glovebox, touch **Controls** > **Glovebox**. The glovebox automatically opens and its light turns on.

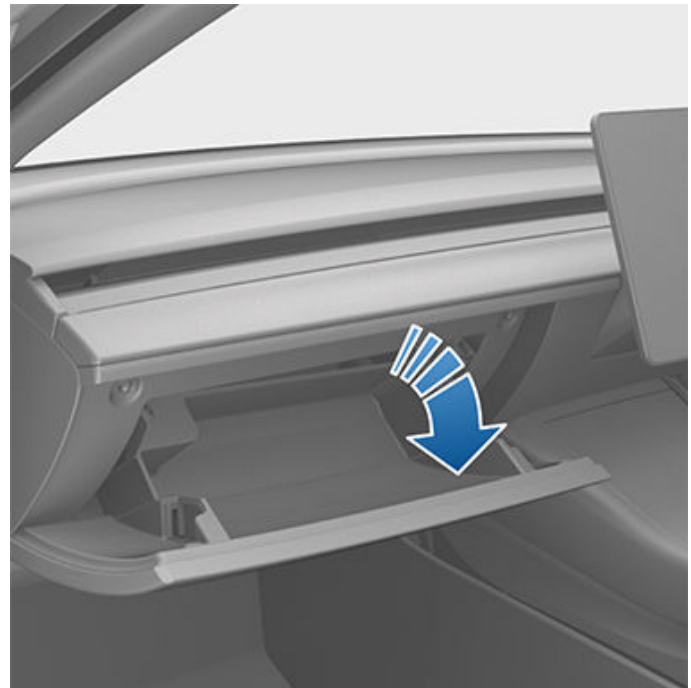

To close the glovebox, push it upward until it clicks into its closed position.

For additional glovebox security, touch **Controls** > **Safety** > **Glovebox PIN** to set a 4-digit PIN (see [Glovebox PIN on page 143](#)).

NOTE: If you leave the glovebox open, its light eventually turns off.

Rear Console

Your Model Y has a rear console integrated in the center of the second row seat back. Pull the console down to access the rear cup holders, or use it as an armrest.

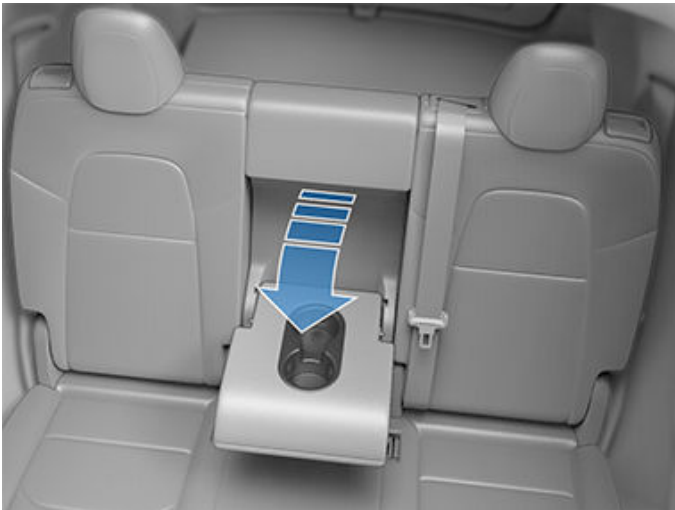

Coat Hangers

Your Model Y has a coat hanger on each side of the vehicle in the second row next to the reading light. Push the coat hanger to release it. Push it again to retract it.



Interior Storage

NOTE: The glovebox locks whenever closed and you lock Model Y using the mobile app, key card, you leave Model Y carrying your phone key (if Walk-Away Door Lock is turned on), or if Valet mode is active (see [Valet Mode on page 97](#)). It does not lock when Model Y is locked by touching the lock icon on the touchscreen.

 **WARNING:** When driving, keep the glovebox closed to prevent injury to a passenger if a collision or sudden stop occurs.



Correct Driving Position

The seat, head support, seat belt and airbags work together to maximize your safety. Using these correctly ensures greater protection.



Position the seat so you can wear the seat belt correctly, while being as far away from the front airbag as possible:

1. Sit upright with both feet on the floor and the seat back in an upright position.
2. Make sure you can easily reach the pedals and that your arms are slightly bent when holding the steering wheel. Your chest should be at least 25 cm from the center of the airbag cover.
3. Place the shoulder section of the seat belt mid-way between your neck and your shoulder. Fit the lap section of the belt tightly across your hips, not across your stomach.

Model Y seats include integrated head supports in the front that cannot be adjusted or removed.

Adjusting the Front Seats

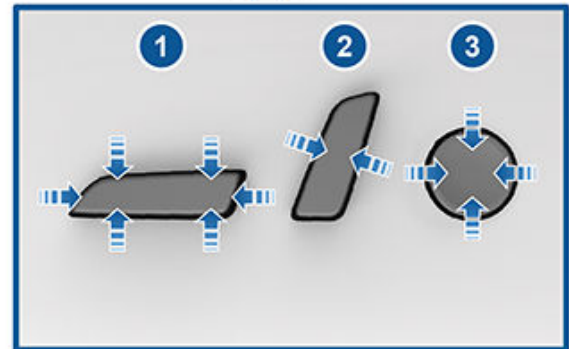

1. Move seat forward/backward and adjust the seat's height and tilt angle up/down.
2. Adjust backrest.
3. Adjust lumbar support.

CAUTION: Do not move a front seat's backrest fully forward when the seat is also in the fully forward position. Doing so can cause the top of the seat to hit, and potentially damage, the sun visor.

WARNING: Before adjusting a front seat, check that the area around the seat is free of obstacles (people and objects).



Front and Rear Seats

WARNING: Do not adjust seats while driving. Doing so increases the risk of a collision.

WARNING: Riding in a moving vehicle with the seat back reclined can result in serious injuries in a collision, as you could slide under the lap belt or be propelled into the seat belt. Ensure your seat back is reclined no more than 30 degrees when the vehicle is moving.

Calibrating Seats

You can calibrate the driver seat. This is useful if you find your seat range limited or your driver profile does not automatically adjust the seat for you. Navigate to **Controls > Service > Driver Seat, Steering & Mirrors Calibration** and follow the instructions on the touchscreen.

WARNING: Ensure nothing is behind or underneath the driver seat during calibration. Failure to do so may cause serious injury.

Adjusting Second Row Seat Backs

Model Y provides seating for up to three passengers in the second row. The seat back is split 60/40 so adjusting the left seat back moves the seat backs for both the left and center seating positions, whereas adjusting the right seat back moves only the rightmost seat back.

Use the adjustment handles on the outside corner of each second row outboard seat back to adjust the corresponding seat back. While pulling and holding the handle, move the seat back to the desired position, and then release the handle. Ensure the seat back is securely latched into position by pushing it forward and rearward.

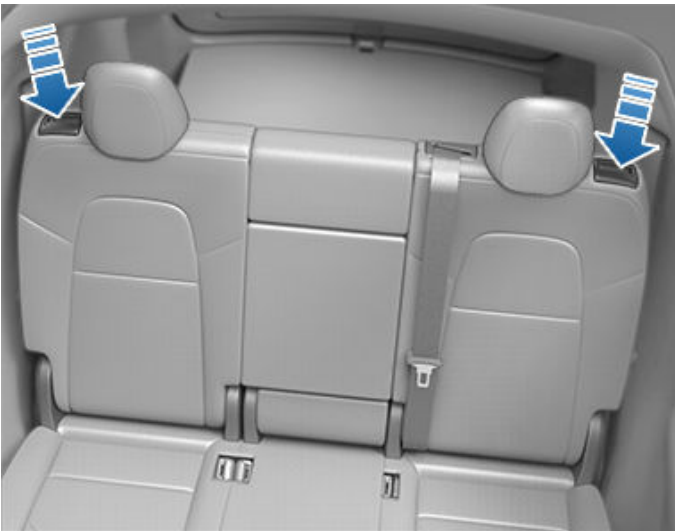

Folding Second Row Seat Backs

To maximize cargo space, each second row seat back can be folded fully forward to lay flat. While pulling and holding the handle, push the corresponding seat back fully forward.

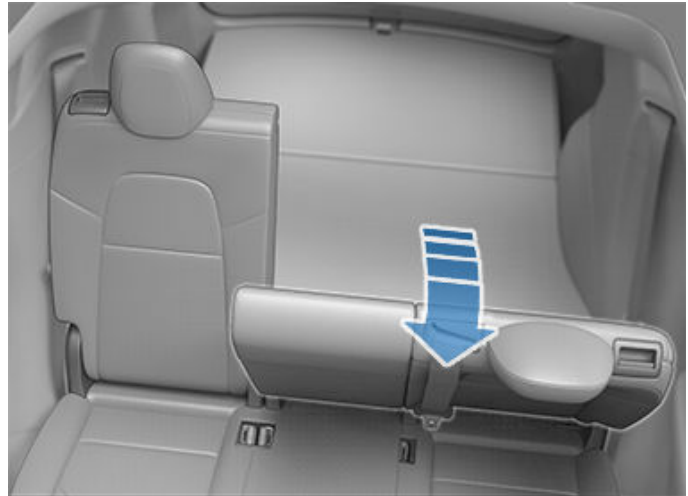

NOTE: Before folding seats fully forward, remove any items from the seats and the rear footwell. To allow the seat backs to fold completely flat, you may need to move the front seats forward.

NOTE: Driving with second row seats folded forward may increase perceivable noise and/or vibration coming from the rear of the vehicle (trunk, suspension, etc.).

To allow you to carry long items (such as skis) in the rear of Model Y, the center seat back can also be independently folded forward. Pull the handle on the rear of the seat back to unlatch it, then pull it forward.



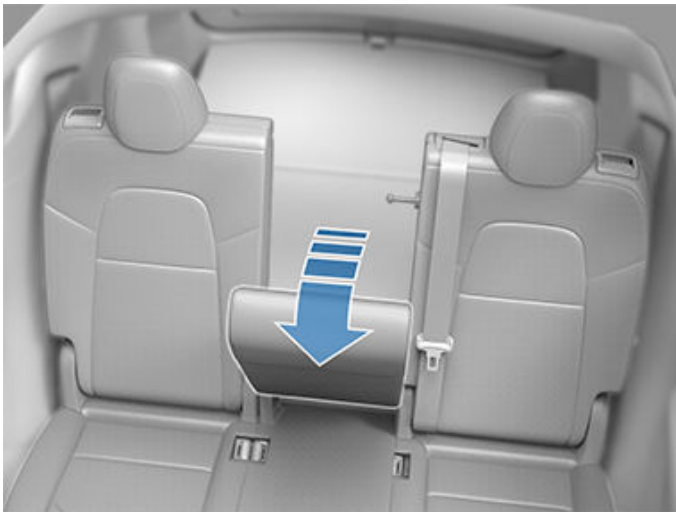

You can also fold the second row seat backs fully forward by pressing the corresponding switch located on the left side of the rear trunk. Pressing the switch causes the seat back to swing forward. You can then push it downward so it lays fully flat.



⚠ WARNING: Before pressing the switch to fold the seat back, you **MUST** keep body parts (hands, fingers, etc.) and objects away from the edges of rear seats. The seat can swing forward with considerable force and cause injury or damage.



To return the seat backs to their upright position, pull it upwards until it locks into place. To confirm that the seat back is locked in the upright position, try pulling it forward.

NOTE: Before raising a second row seat back, make sure that the seat belts are not trapped behind the backrest.

- ⚠ CAUTION:** Before folding seats all the way down, ensure the seat belt is unbuckled and there are no objects remaining on the seat.
- ⚠ WARNING:** Always ensure the seat backs are locked in their upright position by pushing it forward or rearward. Failure to do so increases the risk of injury.

Head Supports

The front seats include integrated head supports that you cannot adjust.

The second row outboard seats include an adjustable head support that you can raise, lower, or remove. When either of these seats is occupied by a passenger that is not in a child safety seat, the corresponding head support should be adjusted (align the center of the head support with the center of the occupant's head) and locked into position. To raise a head support on a second row outboard seat, pull it upward to the desired position. To lower it, press and hold the button on the base of the outer post while pushing it downward.



Front and Rear Seats

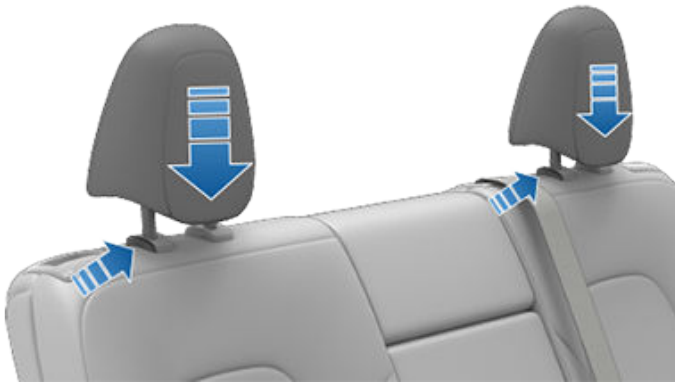

The second row center seats are equipped with the option to raise a head support. Initially stowed into the seat's back rest, you can access the head support by pulling it upward.

⚠ WARNING: When installing a child safety seat in a second row seating position, you must lower the head support. The headrest must be raised and locked in place when sitting in the rear middle seat.

To stow the head support in the second row center seat, press and hold the button on the base of the post while pushing the head support fully downward.



⚠ WARNING: To minimize the risk of severe injury or death in the event of a collision, ensure that head supports are positioned correctly before driving.

Removing/Installing a Head Support

All head supports in the second seating positions can be removed. To remove a head support:

1. Fully raise the head support by pulling it upward.
2. Press and hold the button located at the base of one of the posts.

3. Insert a short, flat object (such as a small flat-head screwdriver) into the opening in the base of the opposite post and pull the head support upward.



To re-install the head support:

1. With the front of the head support facing forward, insert both posts into the corresponding holes on the seat back.
2. Press downward on the head support until it clicks into place.
3. Pull upward on the head support to ensure that it is secure.

⚠ WARNING: Ensure that the head support is correctly installed before seating an occupant. Failure to do so increases the risk of injury or death if a collision occurs.

Seat Heaters

The front and second row seats operate at three levels from 3 (highest) to 1 (lowest). To operate the seat heaters, see [Operating Climate Controls on page 149](#).

⚠ WARNING: To avoid burns resulting from prolonged use, individuals who have peripheral neuropathy, or whose capacity to feel pain is limited because of diabetes, age, neurological injury, or some other condition, should exercise caution when using the climate control system and seat heaters.

Seat Covers

⚠ WARNING: Do not use seat covers on a front seat. Doing so could restrict deployment of the seat-mounted side airbags if a collision occurs. Also, if the vehicle is equipped with an occupant detection system that is used to determine the status of the passenger front airbag, seat covers may interfere with this system.



Wearing Seat Belts

Using seat belts and child safety seats is the most effective way to protect occupants if a collision occurs. Therefore, wearing a seat belt is required by law in most jurisdictions.

All seats are equipped with three-point inertia reel seat belts. Inertia reel belts are automatically tensioned to allow occupants to move comfortably during normal driving conditions.

The seat belt reel automatically tightens or locks to prevent movement of occupants if Model Y experiences a force associated with hard acceleration, braking, cornering, or an impact in a collision.

Seat Belt Reminders



The seat belt reminder on the touchscreen alerts you if a seat belt for an occupied driver or passenger seat is unbuckled. If all occupants are buckled up and the reminder stays on, re-buckle seat belts to ensure they are correctly latched. Also remove any heavy objects (such as a briefcase) from an unoccupied seat. If the reminder light continues to stay on, contact Tesla.

WARNING: Seat belts must be worn by passengers in all seating positions.

NOTE: In regions where regulations require seat belt reminders in rear seating positions, these reminders cannot be disabled. To cancel the reminder in an unoccupied seat when an object is detected, you must either fasten the seat belt or remove the object.

To Fasten a Belt

1. Ensure correct positioning of the seat. See (see [Correct Driving Position on page 31](#)) for details on the correct position of the driver's seat.
2. Draw the belt out smoothly, ensuring the belt lays flat across the pelvis, chest and mid-point of your collar bone, between the neck and shoulder. Ensure the belt is routed correctly and is not twisted. Never sit on the seat belt or any seat belt component.

WARNING: A twisted or incorrectly routed seat belt can cause damage and interfere with the functionality of the seat belt system.

3. Insert the latch plate into the buckle and press together until you hear a click indicating it is locked in place.

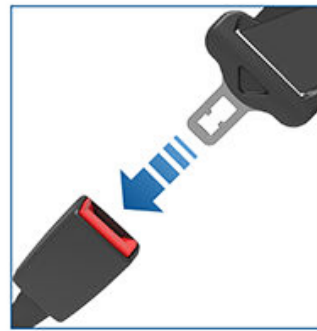

4. Pull the belt to check that it is securely fastened.
5. Pull the diagonal part of the belt toward the reel to remove excess slack.

To Adjust the Shoulder Anchor Height

Model Y is equipped with an adjustable shoulder anchor for each front seat to ensure that the seat belt is positioned correctly. The seat belt should lay flat across the mid-point of your collar bone while in the correct driving position (see [Correct Driving Position on page 31](#)). Adjust the height of the shoulder anchor if the seat belt is not positioned correctly:

1. Press and hold the button on the shoulder anchor to release the locking mechanism.
2. While holding the button, move the shoulder anchor up or down, as necessary, to correctly position the seat belt.

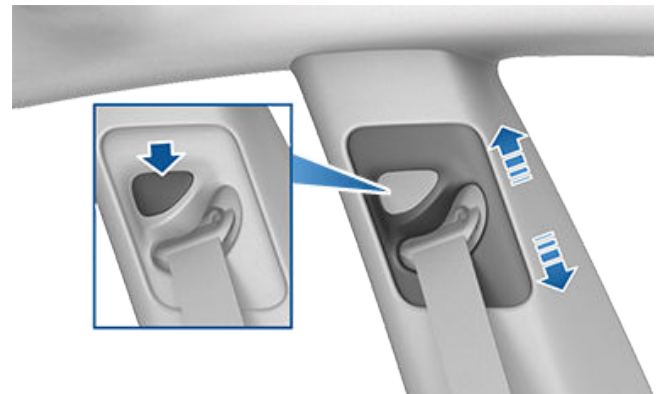

3. Release the button on the shoulder anchor so that it locks into position.
4. Without pressing the button, pull on the seat belt webbing and attempt to move the shoulder anchor downward to check that it is locked into position.

WARNING: Ensure that the seat belt is positioned correctly and that the shoulder anchor is locked into position before driving. Riding in a moving vehicle with the seat belt positioned incorrectly or with the shoulder anchor not locked into position can reduce the effectiveness of the seat belt in a collision.



Seat Belts

To Release a Belt

Hold the belt near the buckle to prevent the belt from retracting too quickly, then press the button on the buckle. The belt retracts automatically. Ensure there is no obstruction that prevents the belt from fully retracting. The belt should not hang loose. If a seat belt does not fully retract, contact Tesla.

Wearing Seat Belts When Pregnant

Do not put the lap or shoulder sections of the seat belt over the abdominal area. Wear the lap section of the belt as low as possible across the hips, not the waist. Position the shoulder portion of the belt between the breasts and to the side of the abdomen. Consult your doctor for specific guidance.



WARNING: If the seat belt is uncomfortable, adjust the seating position instead of wearing the seat belt incorrectly.

WARNING: Never place anything between you and the seat belt to cushion the impact in the event of a collision.

Seat Belt Pre-tensioners

The front seat belts are equipped with pre-tensioners that work in conjunction with the airbags in a collision. The pre-tensioners automatically retract both the seat belt lower anchor and the upper shoulder webbing, reducing slack in both the lap and diagonal portions of the belts, resulting in reduced forward movement of the occupant.



If the pre-tensioners and airbags did not activate in an impact, this does not mean they malfunctioned. It usually means that the strength or type of force needed to activate them was not present.

The second row outboard seats are equipped with shoulder pre-tensioners to retract the seat belt webbing to reduce forward movement of the occupant.

WARNING: Do not bend, sit on, or interfere with the pre-tensioner assembly. Doing so can cause damage that interferes with the proper functionality of the seat belt system.

WARNING: Once the seat belt pre-tensioners have been activated, they must be replaced. After any collision, have the airbags, seat belt pre-tensioners and any associated components checked and, if necessary, replaced.

Testing Seat Belts

To confirm that seat belts are operating correctly, perform these checks on each seat belt.

1. With the seat belt fastened, give the webbing nearest the buckle a quick and forceful pull. The buckle should remain securely locked.
2. With the seat belt fastened, give the webbing closest to the door a quick and forceful pull. The permanent seat belt attachment should remain securely locked. Never attempt to remove this attachment.
3. With the belt unfastened, unreel the webbing to its limit. Check that unreeling is free from snags, and visually check the webbing for wear. Allow the webbing to retract, checking that retraction is smooth and complete.

4. With the webbing half unreeled, hold the tongue plate and pull forward quickly. The mechanism should lock automatically and prevent further unreeling.













If a seat belt fails any of these tests, repair immediately. Do not allow occupants to sit in a seat with a failed seat belt.

For information about cleaning seat belts, see [Seat Belts on page 194](#).

 **WARNING:** When seat belts are not in use, they should be fully retracted and not hanging loose. If a seat belt does not fully retract, schedule a service appointment.

 **WARNING:** The seat belt system has no user serviceable parts and may contain pyrotechnics. Do not disassemble, remove, or replace components.

Seat Belt Warnings

-  **WARNING:** Seat belts should be worn by all occupants at all times, even if driving for a very short distance. Failure to do so increases the risk of injury or death if a collision occurs.
-  **WARNING:** Secure small children in a suitable child safety seat as described in the Owner's Manual. Always follow the child safety seat manufacturer's instructions when installing.
-  **WARNING:** Ensure that all seat belts are worn correctly. An improperly worn seat belt increases the risk of injury or death if a collision occurs.
-  **WARNING:** Never sit on top of any seat belt component. Doing so can cause damage or improper deployment of safety equipment.
-  **WARNING:** Do not wear seat belts over hard, fragile or sharp items in clothing, such as pens, keys, eyeglasses, etc. The pressure from the seat belt on such items can cause injury.
-  **WARNING:** Seat belts should not be worn with any part of the strap twisted.
-  **WARNING:** Each seat belt assembly must be used by one occupant only. It is dangerous to put a seat belt around a child being carried on an occupant's lap.
-  **WARNING:** Seat belts that have been worn in a collision must be inspected or replaced by Tesla, even if damage to the assembly is not obvious.
-  **WARNING:** Seat belts that show signs of wear, or have been cut or damaged in any way must be replaced immediately.
-  **WARNING:** Avoid contaminating a seat belt's components with any chemicals, liquids, grit, dirt or cleaning products. If a seat belt fails to retract or latch into the buckle, it must be replaced immediately. Use the mobile app to schedule a service appointment.
-  **WARNING:** Do not make modifications or additions that can prevent a seat belt mechanism from taking up slack, or that can prevent a seat belt from being adjusted to remove slack. A seat belt with slack greatly reduces occupant protection.
-  **WARNING:** Do not make modifications that can interfere with the operation of a seat belt, or that can cause a seat belt to become inoperable.
-  **WARNING:** Do not use after market comfort and convenience products that attach to the seat belts.



Passenger Front Airbag Must Be OFF

WARNING: If seating a child on the front passenger seat is permissible in your market region, never seat a child on the front passenger seat when the passenger front airbag is active. Always ensure this airbag is OFF (see).

Refer to the following label fitted to the sun visors:

When an infant or child is seated in the front passenger seat (even when the child is seated in a suitable child restraint system or booster seat), you must disable the passenger front airbag. If a collision occurs, the inflation of the airbag can cause serious injury or death, especially when using a rear-facing child restraint system.

To disable the passenger front airbag, first ensure the vehicle is in Park. Then touch **Controls > Safety > Passenger Front Airbag** (see).

WARNING: When you disable the passenger front airbag, remember to subsequently enable it when an adult occupant is seated in the front passenger seat.

The status of the passenger front airbag displays in the top corner of the touchscreen. You can also touch this status icon to disable and enable the passenger front airbag:



Before driving with a child seat on the front passenger seat, always double-check the status of the passenger front airbag to confirm that it is OFF.



To protect an adult subsequently occupying the front passenger seat, remember to turn the passenger front airbag back ON.

WARNING: It is the driver's responsibility to confirm that the passenger front airbag is OFF when a child is seated in the front passenger seat.

WARNING: If the passenger front airbag is ON, even if you have turned it OFF (or vice versa), use the mobile app to schedule a service appointment immediately.

Suitability and Fitting of Child Restraint Systems

All Model Y seat belts are designed for adults. When seating infants and children, you must:

- Use a child restraint system appropriate for the child's age, weight, or size (see [Recommended Child Restraint Systems on page 38](#)).
- Use a child restraint system that is appropriate for the specific seating position in Model Y. Each passenger seat supports a broad range of options. For details on what type of child restraint system can be used in each passenger seat, see [Front Passenger Seat on page 40](#), [Second Row Outboard Seats on page 41](#), and [Second Row Center Seat on page 42](#).
- Properly install the child restraint system by following the manufacturer's instructions (see [Installing Belt-based Child Restraint Systems on page 43](#) and [Installing ISOFIX/i-Size Child Restraint Systems on page 43](#) for general guidelines).

NOTE: When installing a child restraint system, you must also buckle the seat belt to silence the seat belt warning chime.

Recommended Child Restraint Systems

In the table below, Tesla provides recommended child restraint systems based a child's weight group (as defined in ECE R44 "Uniform Provisions Concerning Restraining Devices for Child Occupants"). Although all weight groups can occupy any passenger seat in Model Y, the type of child restraint system that can be used in each seat can vary. For example, only belt-based child restraint systems (as defined in [Two Installation Methods on page 40](#)) can be used in the second row center passenger seat.

Weight Group/ Size	Child Weight	Tesla Recommended
Group 0+	Up to 13 kg (12-18 months)	Maxi-Cosi CabrioFix i-Size & Familyfix 3 / CabrioFix i-Size Base



Weight Group/ Size	Child Weight	Tesla Recommended
45-105 cm		Maxi-Cosi Pearl 360 with Familyfix 360
100-150 cm		Britax Romer KIDFIX i-Size (see instructions below)

Britax Romer KIDFIX i-Size

When using the Britax Romer KIDFIX I-Size child restraint system as recommended by Tesla for children 100-150 cm, you must also use the Britax SecureGuard. When using the Britax SecureGuard, keep the lap belt flat across the child's hips. Do not put the sash belt under the SecureGuard. For details, refer to the instructions provided by Britax.

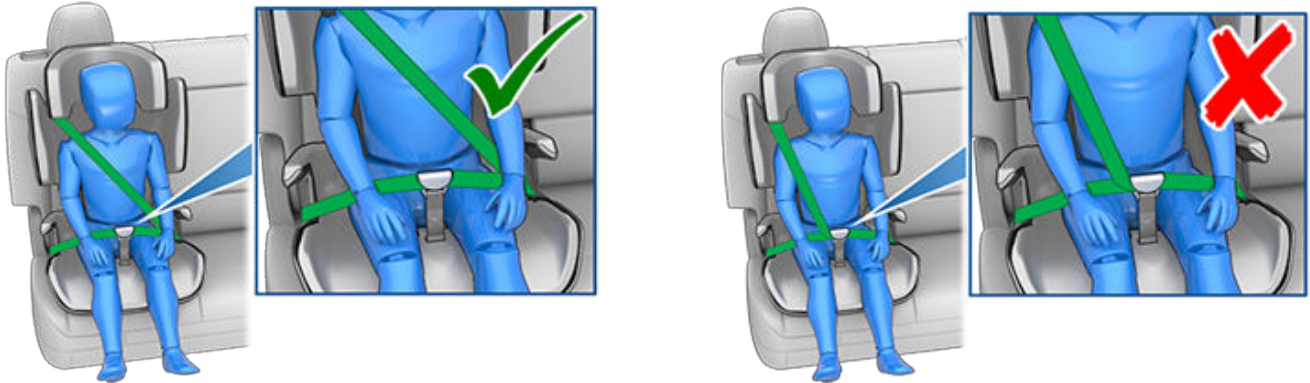

Seating Larger Children



If a child is too large to fit into a child restraint system, but too small to be safely secured using the vehicle's seat belts, use a booster seat appropriate for the child's age and size. For children needing a booster seat, Tesla recommends using the base of the . When using and installing a booster seat, carefully follow the instructions provided by the manufacturer.



Two Installation Methods

NOTE: Always install child restraint systems by following the instructions provided by the manufacturer of the child restraint system.

Among many other variants, there are two general types of child restraint systems based on how they are secured in the seat:

- Belt-based - secured using the vehicle's seat belts (see [Installing Belt-based Child Restraint Systems on page 43](#)).
- ISOFIX/i-Size - secured to anchor bars built into the vehicle's seats (see [Installing ISOFIX/i-Size Child Restraint Systems on page 43](#)).

Some child restraint systems can be installed using either method. Refer to the instructions provided by the manufacturer of the child restraint system to determine which installation method to use and for detailed installation instructions.

In Model Y, belt-based child restraints can be installed in any passenger seat and ISOFIX/i-Size systems can be installed in either of the second row outboard seats. Specific details about the type of child restraint system that can be used in each seat is provided next.

NOTE: ISOFIX and i-Size are international standards for integrated anchors used in passenger vehicles to attach child safety seats.

⚠ WARNING: Do not use ISOFIX/i-Size anchors with child restraint system or booster seats that have an integral safety belt where the combined weight of the child plus the child restraint system exceeds 33 kg.

Front Passenger Seat

⚠ WARNING: Never seat a child on the front passenger seat when the passenger front airbag is active. Doing so can cause serious injury or death. See .

⚠ WARNING: To accommodate a belt-based child restraint system in the front seat, you must raise the seat upward to the mid-height position (approximately 3 cm).

When the passenger front airbag is disabled and the seat bottom is raised half way up, infants and children can occupy the front passenger seat using the following types of belt-based child restraint systems:

- Forward-facing, Universal.
- Rear-facing, Universal.

NOTE: The front passenger seat is not equipped with lower anchor bars to support the installation of ISOFIX/i-Size child restraint systems.

Weight Group	Child Weight	Passenger Front Airbag ON	Passenger Front Airbag OFF
Group 0	Up to 10 kg	Not Allowed	Allowed
Group 0+	Up to 13 kg	Not Allowed	Allowed
Group I	9 to 18 kg	Not Allowed	Allowed
Group II	15 to 25 kg	Not Allowed	Allowed
Group III	22 to 36 kg	Not Allowed	Allowed

Second Row Outboard Seats

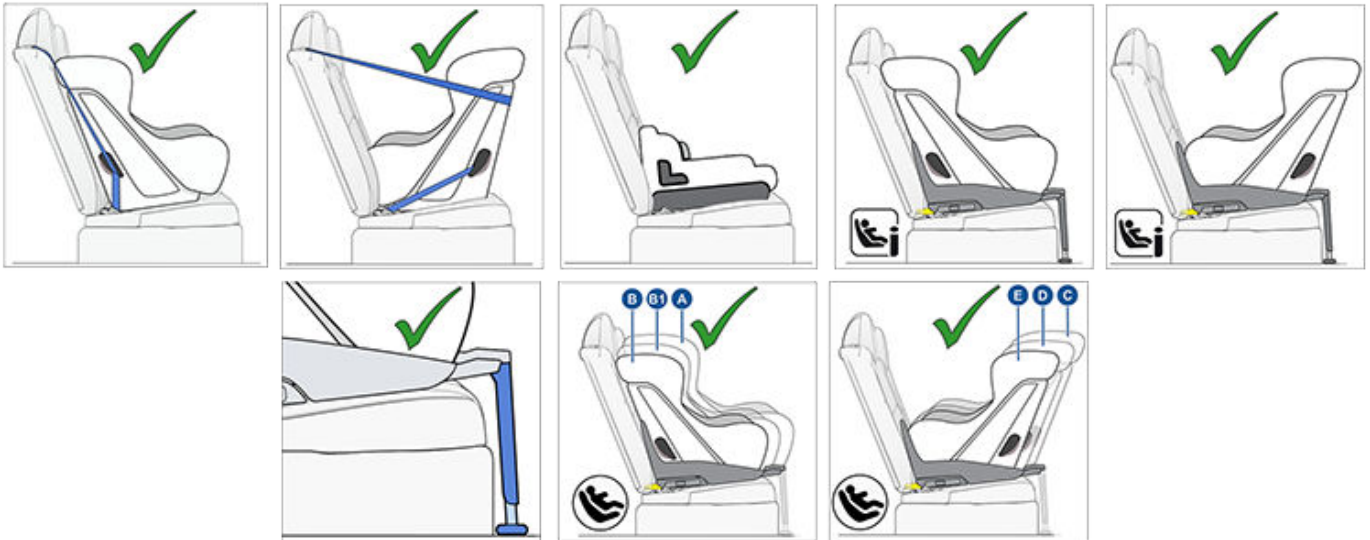
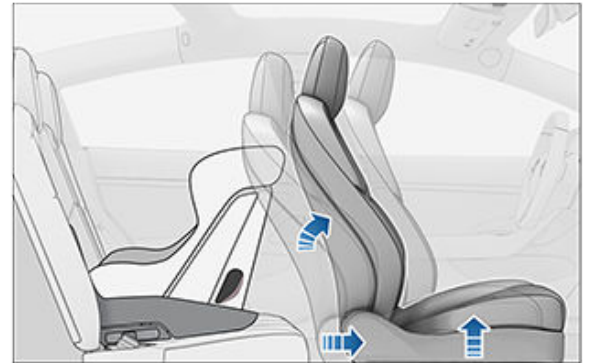
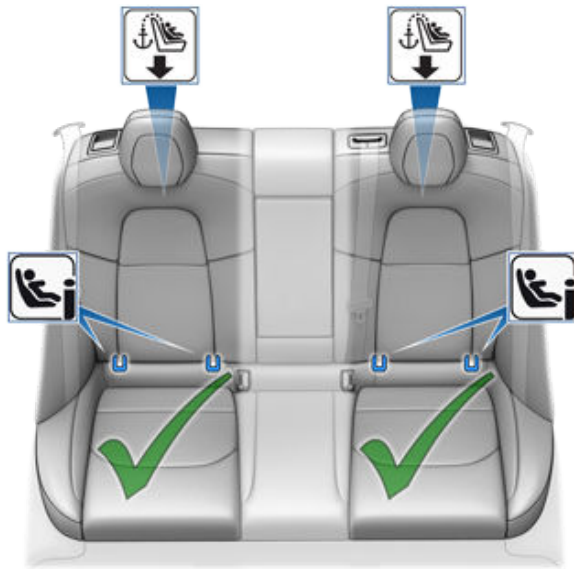

Infants and children can occupy a second row outboard seat using either belt-based, or ISOFIX (IU)//i-Size (i-U) child restraint systems.

Larger children can also occupy a second row outboard seat using a booster seat, either attached to the lower anchor bars or belted, as described in the instructions provided by the child restraint system manufacturer.

The second row outboard seats support the use of the following ISOFIX/i-Size size classes:

- Size class A, B, and B1 forward-facing.
- Size class C, D and E rear-facing.

NOTE: All rear seats support the use of upper tether straps (see [Attaching Upper Tether Straps](#) on page 44).

NOTE: Before installing a child restraint system, ensure the seat's corresponding back rest is adjusted to the most upright position.

NOTE: To accommodate large rear-facing ISOFIX/i-Size child restraint systems (size class C), you may need to move the corresponding front seat forward to the mid-track position (up to 13 cm forward of the rearmost position), raise the seat upward (2 cm from its lowest position), and angle the seat back as needed.

NOTE: If the vehicle headrest prevents the child restraint system from touching the seat's back or side bolsters, temporarily remove the headrest for a better fit. Reinstall the headrest once the child restraint system is no longer in use.



Child Safety Seats

WARNING: Do not use **Easy Entry** (see [Driver Profiles](#) on page 96) to automatically move the driver's seat to the full rearward position if a child safety seat is installed on the second row seat located behind the driver's seat. With reduced clearance, the movement of the seat may impact a child's legs, cause injury, or dislodge the seat.

Second Row Center Seat

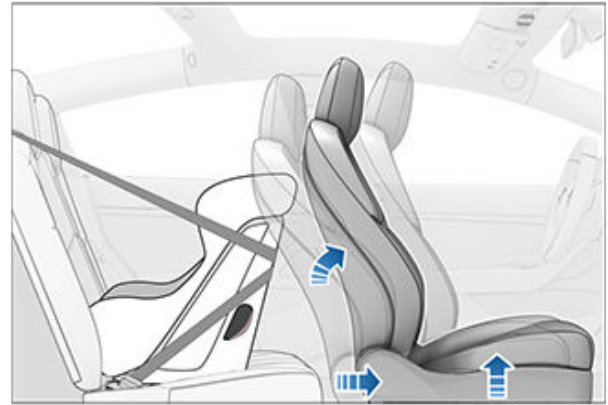
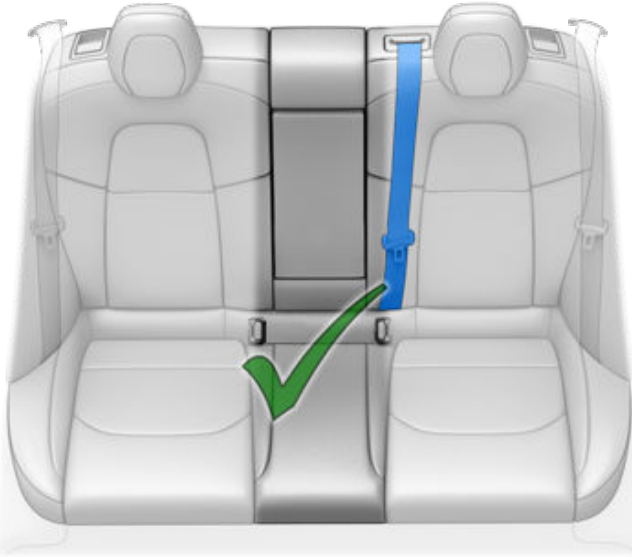

Infants can occupy the second row center seat using a rear-facing belt-based child restraint system. Children can occupy the second row center seat using either a rear-facing or a forward-facing belt-based child restraint system.

NOTE: The second row center seat is not equipped with lower anchor bars to support the installation of ISOFIX/i-Size child restraint systems.

NOTE: Before installing a child restraint system, ensure the seat's corresponding back rest is adjusted to the most upright position. To ensure a good fit in the center seat, the seat backs on both the left and right outboard seating positions may need to be in the same position.



Larger children can also occupy the second row center seat using a booster seat, installed as described in the instructions provided by the manufacturer of the child restraint system.

Installing Belt-based Child Restraint Systems

Always follow the detailed instructions provided by the manufacturer of the child restraint system. Follow these general guidelines for belt-based child restraint systems:

- Ensure that the child restraint system is appropriate for the weight, height, and age of the child.
 - Avoid dressing the child in bulky clothing.
 - Do not place any objects between the child and the child restraint system.
 - Adjust the child restraint system's harnesses for every child, every trip.
1. Place the child restraint system in the appropriate seat and fully extend the seat belt. Route and buckle the seat belt in accordance with the instructions provided by the manufacturer of the child restraint system.



2. Allow the seat belt to retract, and remove all slack in the seat belt while firmly pushing the child restraint system into the vehicle's seat.
3. Attach the upper tether strap(s), as required by the manufacturer of the child restraint system (see [Attaching Upper Tether Straps on page 44](#)).

Installing ISOFIX/i-Size Child Restraint Systems

Second row outboard seating positions are equipped with ISOFIX/i-Size anchor bars. These anchor bars are located between the seat's cushion and back rest. The exact location of each anchor bar is identified by a marking located on the seat back, directly above its associated anchor bars.



In the second row, install ISOFIX/i-Size child safety seats in the outboard seating positions only. Use only a seat belt retained seat in the center position.

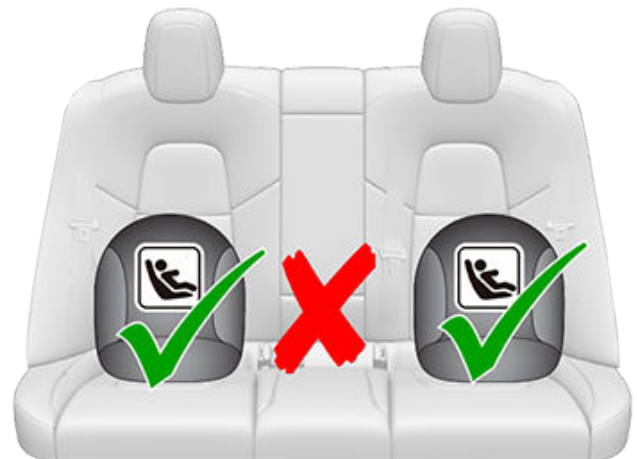

To install an ISOFIX/i-Size child restraint system, carefully read and follow the instructions provided by the manufacturer of the child restraint system. These instructions describe how to slide the child restraint system onto the seat's anchor bars until you hear it "click" into place. You may need to push the child restraint system firmly against the seat back to ensure it fits snugly.



Child Safety Seats



Before seating a child, ensure that the child restraint system is securely installed. Grasp the front of the child restraint system with one hand on each side, and attempt to:

- Twist the child restraint system from side to side.
- Pull the child restraint system away from the seat.

If the child restraint system rotates or moves away from the seat, both latches are not fully engaged onto the seat's anchor bars. You must reinstall it and try again. It is critical that both latches on the child restraint system are fully engaged.

WARNING: Do not use ISOFIX/i-Size anchors with child restraint system or booster seats that have an integral safety belt where the combined weight of the child plus the child restraint system exceeds 33 kg.

Safety Leg

All passenger seats Model Y support the use of a child restraint system with a safety leg. If the child restraint system is equipped with a leg, extend the leg as described in the instructions provided by the manufacturer of the child restraint system.

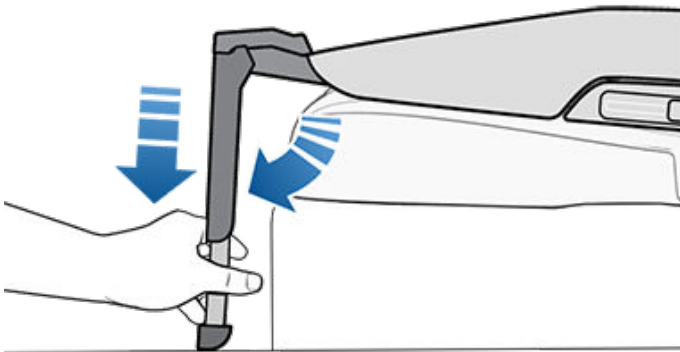

Attaching Upper Tether Straps

If an upper tether strap is provided, attach its hook to the anchor point located behind the rear seat.

NOTE: The location of anchor points may not be readily visible but can be found by identifying a slice in the seat's material.

WARNING: Tighten upper tether straps according to the instructions provided by the manufacturer of the child safety seat.

WARNING: USE ONLY SEAT BELT RETAINED CHILD SAFETY SEATS IN THE CENTER SEATING POSITION.



Make sure the hook is fully seated on the anchor point.



For dual-strap tethers in the second row, position a strap on each side of the head support.

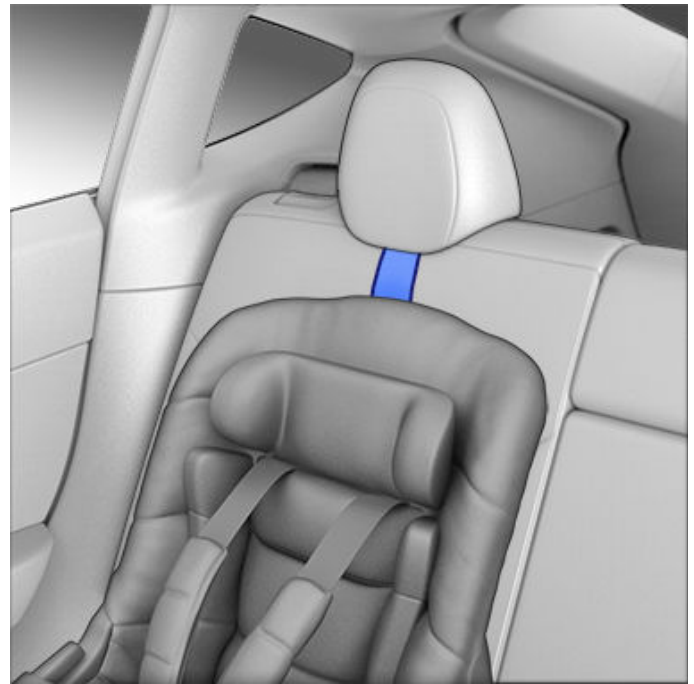

⚠ WARNING: Before routing a tether strap **OVER** a head support, you **MUST LOWER** the head support (see [Head Supports on page 33](#)).

For single-strap tethers at the outboard seating positions in the second row, route the strap over the outside-facing side of the head support (same side of the head support as the seat belt retraction mechanism).



If routing the strap over the outside-facing side of the head support is not possible (such as there is not enough slack in the strap), raise the head support (see [Head Supports on page 33](#)) and route the strap under the head support.



Technical Information

ECE 16-08 Annex 17, Appendix 3, Table 1

	Seat Position Number (see below)						
	1 and 3 Pass Airbag OFF	1 and 3 Pass Airbag ON	4	5	6	7 (if equipped)	9 (if equipped)
Weight Groups Allowed	0, 0+, I, II, III	n/a	0, 0+, I, II, III	0, 0+, I, II, III	0, 0+, I, II, III	0, 0+, I, II, III	0, 0+, I, II, III
Suitable for universal belted?	Yes*	No	Yes	Yes	Yes	Yes***	Yes***
Suitable for i-Size?	No	No	Yes	No	Yes	No	No
Suitable for lateral (L1/L2)?	No	No	No	No	No	No	No
Largest suitable rearward-facing ISOFIX/i-Size (R1/R2X/R2/R3).	No	No	R3*	No	R3**	No	No
Largest suitable forward-facing ISOFIX/i-Size (F1/F2X/F2/F3).	No	No	F3	No	F3	No	No
Largest suitable booster seat (B2/B3).	B2*	No	B3	No	B3	No	No
Suitable for safety leg	Yes	No	Yes	Yes	Yes	No	No

Adult safety belt buckles are not located laterally between ISOFIX/i-Size anchor bars in any seat.

*To accommodate a belt-based child restraint system (CRS) in the front seat, you must raise the seat upward to the mid-height position (~3 cm) and rearward to allow for room between the CRS and the dashboard.

**To accommodate large ISOFIX/i-Size child restraint systems (size class C), you may need to move the corresponding front seat forward to the mid-track position (up to 13 cm forward of the rearmost position), raise the seat upward (3 cm from its lowest position), and angle the seat back to 15 degrees (or 10 degrees rearward from its forward-most position).

*** When a universal belted child restraint system is installed in the third row, the outboard and center seats in the second row cannot be used.











Summary of Seat Position Numbers



Seat Position	Location in Vehicle
1	Front Left (RHD vehicles only)
3	Front Right (LHD vehicles only)
4	Second Row Left
5	Second Row Center



Seat Position	Location in Vehicle
6	Second Row Right
7	Third Row Left
9	Third Row Right

Child Restraint System Warnings

-  **WARNING:** Never seat a child in a child restraint system or a booster seat on the front passenger seat when the passenger front airbag is active. Doing so can cause serious injury or death.
-  **WARNING:** Never use a rearward facing child restraint system on a seat protected by an active passenger front airbag. Doing so can cause serious injury or death. Refer to the warning label located on the sun visor.
-  **WARNING:** Some child restraint systems are designed to be secured in vehicle seats by lap belts or the lap belt portion of a lap-shoulder belt. Children could be endangered in a crash if their child restraint systems are not properly secured in the vehicle.
-  **WARNING:** Do not use a forward-facing child restraint system until your child weighs over 9 kg and can sit independently. Up to the age of two, a child's spine and neck are not sufficiently developed to avoid injury in a frontal impact.
-  **WARNING:** Do not allow a baby or infant to be held on an adult's lap. All children should be restrained in an appropriate child restraint system at all times.
-  **WARNING:** To ensure children are safely seated, follow all instructions provided in this document and by the manufacturer of the child restraint system.
-  **WARNING:** The seat belt reminder on the touchscreen is not a substitute for checking if a small occupant or a child safety seat is properly secured. The seat occupancy sensors may not identify small occupants or child seats.
-  **WARNING:** Children should ride in a rear-facing child restraint system using the seat's integrated 5-point harness for as long as possible until they reach the maximum size or weight limit of the rear-facing child restraint system.
-  **WARNING:** When seating larger children, make sure the child's head is supported and the child's seat belt is properly adjusted and fastened. The shoulder portion of the belt must be away from the face and neck, and the lap portion must not be over the stomach.
-  **WARNING:** Never attach two child restraint systems to one anchor point. In a collision, one anchor point may be incapable of securing both seats.
-  **WARNING:** Child restraint anchor bars are designed to withstand only those loads imposed by correctly fitted child restraints. Under no circumstances are they to be used for adult seat belts, harnesses, or for attaching other items or equipment to the vehicle.

-  **WARNING:** Always check harnesses and tether straps for damage and wear.
-  **WARNING:** Never leave a child unattended, even if the child is secured in a child restraint system.
-  **WARNING:** Never use a child restraint system that has been involved in a collision. Discard the seat and have it replaced as described in the child restraint system manufacturer's instructions.



Seat Children in Rear Seats Only

WARNING: The front passenger seat has an airbag that is always ON and may inflate when a collision occurs. Never seat a child on the front passenger seat, even if using a child restraint system or booster seat. DEATH or SERIOUS INJURY could occur.

Refer to the following label fitted to the sun visor:



The Passenger Airbag On indicator displays in the top corner of the touchscreen to indicate that the passenger front airbag may inflate if a collision occurs.

Suitability and Fitting of Child Restraint Systems

All Model Y seat belts are designed for adults. When seating infants and children, you must:

- Use a child restraint system appropriate for the child's age, weight, or size (see [Recommended Child Restraint Systems on page 49](#)).
- Use a child restraint system that is appropriate for the specific seating position in Model Y. Each passenger seat in Model Y supports a broad range of options. For details on what type of child restraint system can be used in each passenger seat, see [Front Passenger Seat on page 52](#), [Second Row Outboard Seats on page 53](#), and [Second Row Center Seat on page 55](#).
- Properly install the child restraint system by following the manufacturer's instructions (see [Installing Belt-based Child Restraint Systems on page 56](#) and [Installing ISOFIX/i-Size Child Restraint Systems on page 56](#) for general guidelines).

NOTE: When installing a child restraint system, you must also buckle the seat belt to silence the seat belt warning chime.



Recommended Child Restraint Systems

Although all weight groups can occupy any passenger seat in Model Y, the type of child restraint system that can be used in each seat can vary. For example, only belt-based child restraint systems (as defined in [Two Installation Methods on page 51](#)) can be used in the second row center seat.

Choose a child restraint system that meets one of: FMVSS 213, ECE R44, ECE R129, or AS/NZS 1754. For more information about child seats, go to www.govt.nz/browse/transport/car-seats-for-kids/.

In the table below, Tesla provides recommended child restraint systems based a child's weight group (as defined in ECE R44 "Uniform Provisions Concerning Restraining Devices for Child Occupants"). Although all weight groups can occupy any passenger seat in Model Y, the type of child restraint system that can be used in each seat can vary. For example, only belt-based child restraint systems (as defined in [Two Installation Methods on page 51](#)) can be used in the center seat in the second row.

Stature	Weight Group	Child Weight	Tesla Recommended
-	Group 0+	Up to 13 kg	Maxi-Cosi CabrioFix i-Size & Familyfix 3 / CabrioFix i-Size Base
45-105 cm	-	-	Maxi-Cosi Pearl 360 with Familyfix 360
-	Group I	9-18 kg	Britax Römer King 11 LS
-	Group II	15-25 kg	Britax Römer Kidfix i-Size (with Britax SecureGuard)
100-150 cm	-	-	Britax Römer Kidfix i-Size (with Britax SecureGuard, see instructions below)
-	Group III	22-36 kg	Peg Perego Viaggio 2-3 Shuttle Base



WARNING: To ensure safety of infants and children, it is advisable to purchase a new child restraint system. However, if a used child restraint system is necessary, heed these warnings:

- Do not use a child restraint system that is more than 10 years old.
- Confirm that the child restraint system was not being used in a vehicle that was involved in a collision.
- Ensure that all components (buckles, etc.) of the child restraint system operate smoothly and there are no signs of wear or damage (splits, cracks etc.).
- Ensure the harnesses on the child restraint system are not frayed, worn or damaged
- Ensure the child restraint system has an instruction manual.

Britax Romer KIDFIX i-Size

When using the Britax Romer KIDFIX i-Size child restraint system as recommended by Tesla for children 100-150 cm, you must also use the Britax SecureGuard. When using the Britax SecureGuard, keep the lap belt flat across the child's hips. Do not put the sash belt under the SecureGuard. For details, refer to the instructions provided by Britax.



Child Safety Seats

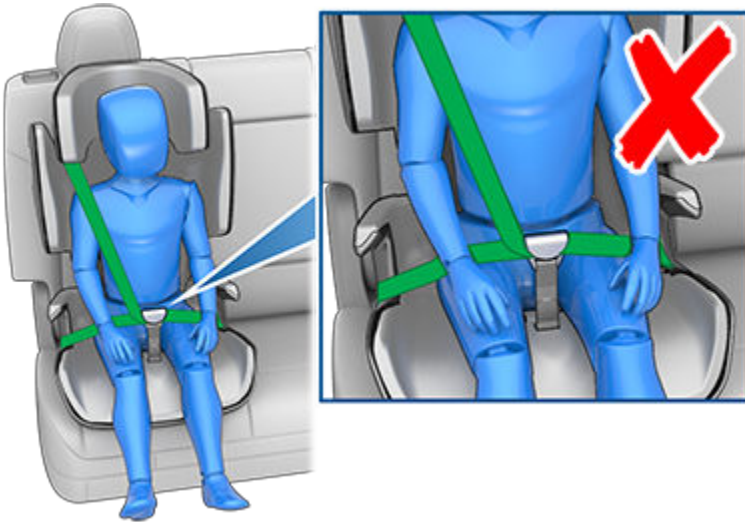
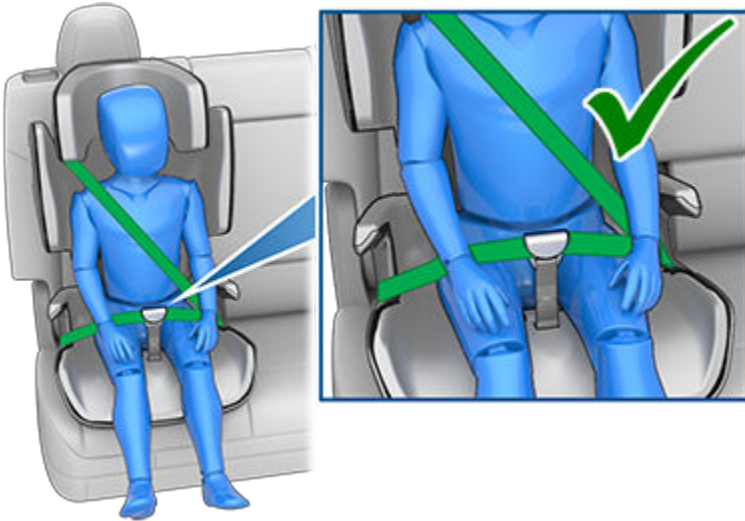

Seating Larger Children





If a child is too large to fit into a child restraint system, but too small to be safely secured using the vehicle's seat belts, use a booster seat appropriate for the child's age and size. For children needing a booster seat, Tesla recommends using the base of the Peg Perego Viaggio 2-3 Shuttle. When using and installing a booster seat, carefully follow the instructions provided by the manufacturer.

Two Installation Methods

NOTE: Always install child restraint systems by following the instructions provided by the manufacturer of the child restraint system.

Among many other variants, there are two general types of child restraint systems based on how they are secured in the seat:

- Belt-based - secured using the vehicle's seat belts (see [Installing Belt-based Child Restraint Systems on page 56](#)).
- ISOFIX/i-Size - secured to anchor bars built into the vehicle's seats (see [Installing ISOFIX/i-Size Child Restraint Systems on page 56](#)).

Some child restraint systems can be installed using either method. Refer to the instructions provided by the manufacturer of the child restraint system for detailed installation instructions.

In Model Y, belt-based child restraints can be installed in any rear passenger seat and ISOFIX/i-Size systems can be installed in either outboard seat in the second row. Specific details about the type of child restraint system that can be used in each seat is provided next.

NOTE: ISOFIX and i-Size are international standards for integrated anchors used in passenger vehicles to attach child safety seats.



WARNING: Do not use ISOFIX/i-Size anchors with child restraint system or booster seats that have an integral safety belt where the combined weight of the child plus the child restraint system exceeds 33 kg.



Front Passenger Seat

- WARNING:** The front passenger seat has an airbag that is always ON and may inflate when a collision occurs. Inflation of this airbag could cause DEATH or SERIOUS INJURY to a child seated on the front passenger seat, even if using a child restraint system or booster seat.
- WARNING:** Never seat a child in a rear-facing child restraint system on the front passenger seat. Doing so can cause DEATH or SERIOUS INJURY.
- WARNING:** To accommodate a belt-based child restraint system in the front seat, you must raise the seat upward to the mid-height position (raise it approximately 3 cm).

NOTE: The front passenger seat is not equipped with lower anchor bars to support the installation of ISOFIX child restraint systems. The front passenger seat is also not equipped with an upper tether anchor.



- WARNING:** NEVER seat a child less than four years old in the front row of a vehicle that has two or more rows of seats.
- WARNING:** Children between the ages from four to seven cannot travel in the front seat of a vehicle that has two or more rows, unless all rear seating positions are occupied by younger children seated in approved child restraint systems. In this situation, the oldest or largest child can be seated in the front passenger seat using a booster seat and the seat belt.
- WARNING:** Children in booster seats must be restrained by a suitable and approved lap and sash type seat belt that is properly adjusted and fastened, or by a suitable and approved child safety harness that is properly adjusted and fastened.



Second Row Outboard Seats

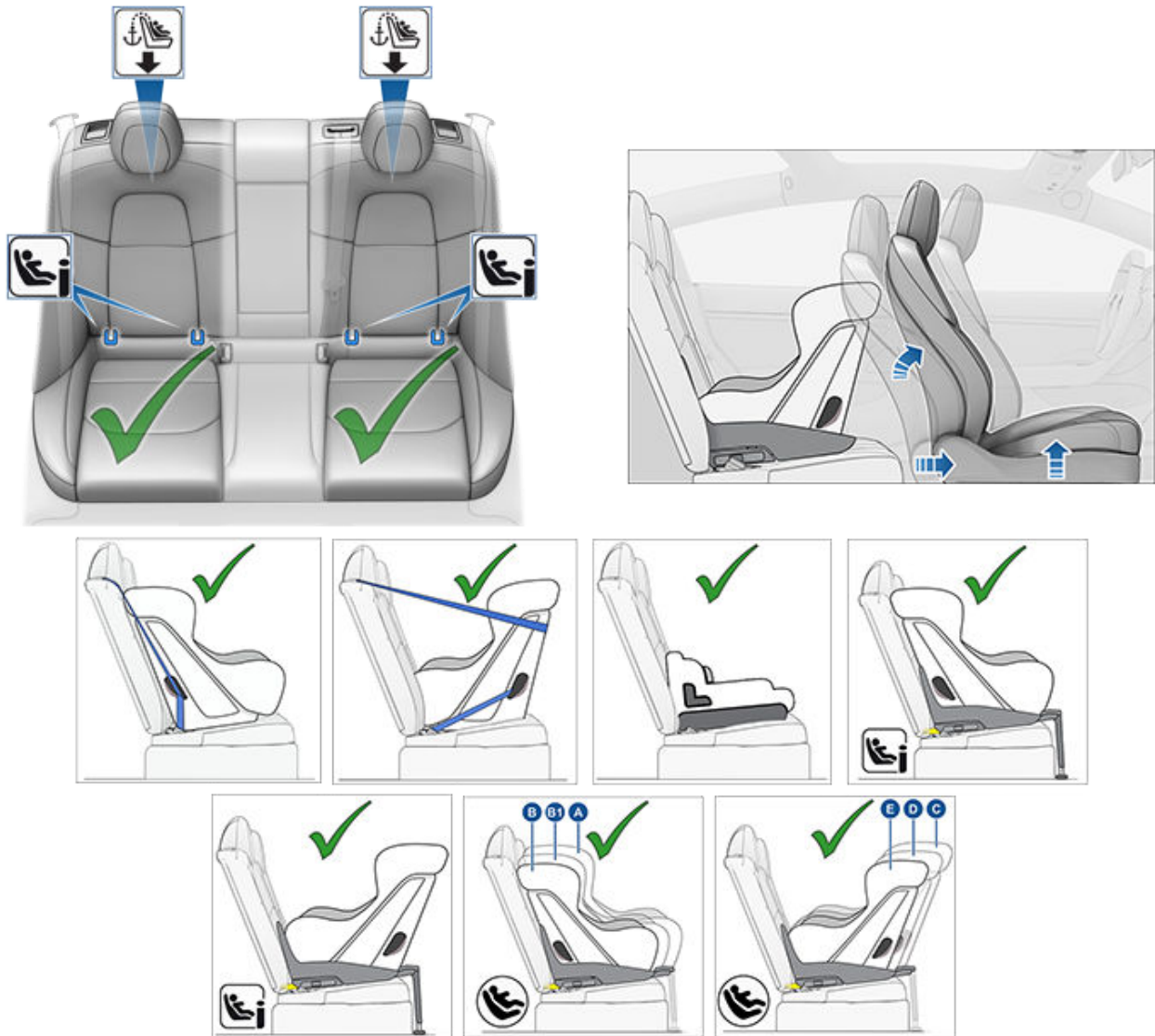

Infants and children can occupy an outboard seat in the second row using either belt-based, or ISOFIX (IU)//i-Size (i-U) child restraint systems.

NOTE: Seats in the second row support the use of upper tether straps (see [Attaching Upper Tether Straps on page 57](#)).

Larger children can also occupy a second row outboard seat using a booster seat, either attached to the lower anchor bars or belted, as described in the instructions provided by the child restraint system manufacturer.

The second row outboard seats support the use of the following ISOFIX size classes:

- Size class A, B, and B1 forward-facing.
- Size class C, D and E rear-facing.
- Also compatible with AS/NZS 1754 child restraint systems Type A, A2, A4, B, D, E, and F.

NOTE: To accommodate large rear-facing ISOFIX child restraint systems (size class C), you may need to move the corresponding front seat forward to the mid-track position (up to 13 cm forward of the rearmost position), raise the seat upward (2 cm from its lowest position), and angle the seat back as needed.



Child Safety Seats

⚠ WARNING: Do not use **Easy Entry** (as described in [Driver Profiles on page 96](#)) to automatically move the driver's seat to the full rearward position if a child safety seat is installed on a second row seat behind the driver's seat. With reduced clearance, the movement of the seat may impact a child's legs, cause injury, or dislodge the seat.



Second Row Center Seat

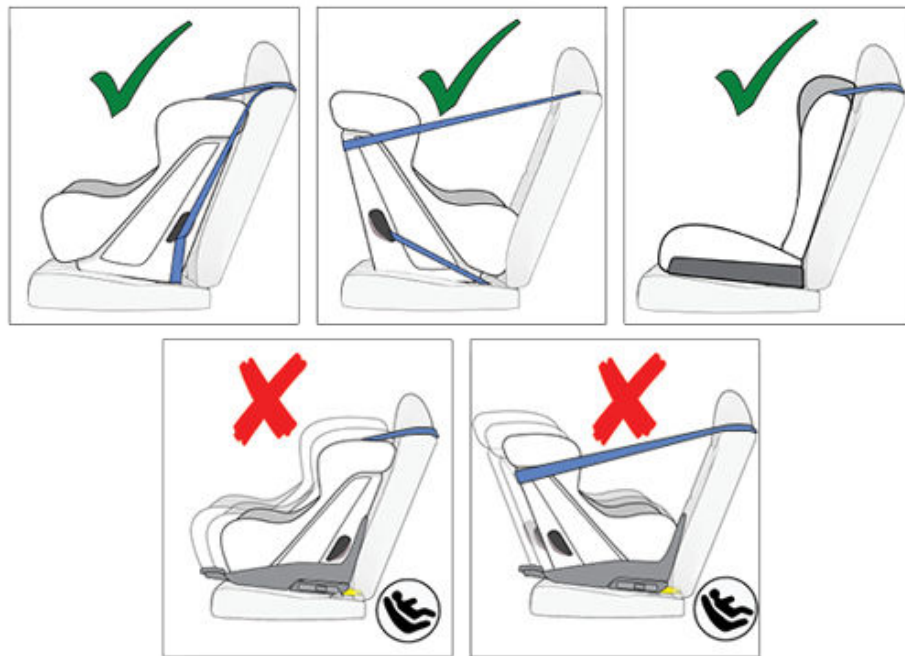
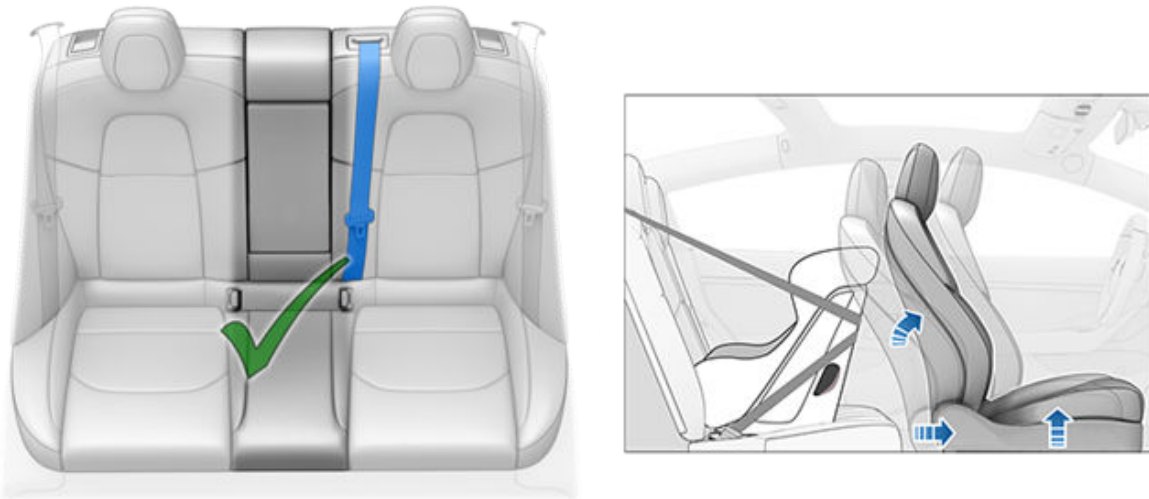

Infants can occupy the second row center seat using a rear-facing belt-based child restraint system. Children can occupy the second row center seat using either a rear-facing or a forward-facing belt-based child restraint system.

Compatible with AS/NZS 1754 child restraint systems Type A, A2, A4, B, D, E, and F.

NOTE: The second row center seat is not equipped with lower anchor bars to support the installation of ISOFIX/i-Size child restraint systems.

Larger children can also occupy a second row center seat using a booster seat, installed as described in the instructions provided by the manufacturer of the child restraint system.



Child Safety Seats

Installing Belt-based Child Restraint Systems

Always follow the detailed instructions provided by the manufacturer of the child restraint system. Follow these general guidelines for belt-based child restraint systems:

- Ensure that the child restraint system is appropriate for the weight, height, and age of the child.
- Avoid dressing the child in bulky clothing.
- Do not place any objects between the child and the child restraint system.
- Adjust the child restraint system's harnesses for every child, every trip.

1. Place the child restraint system in the appropriate seat and fully extend the seat belt. Route and buckle the seat belt in accordance with the instructions provided by the manufacturer of the child restraint system.



To install an ISOFIX/i-Size child restraint system, carefully read and follow the instructions provided by the manufacturer of the child restraint system. These instructions describe how to attach the child restraint system to the lower anchor bars.

2. Allow the seat belt to retract, and remove all slack in the seat belt while firmly pushing the child restraint system into the vehicle's seat.
3. Attach the upper tether strap(s), as required by the manufacturer of the child restraint system (see [Attaching Upper Tether Straps on page 57](#)).

Installing ISOFIX/i-Size Child Restraint Systems

Model Y's second row outboard seating positions are equipped with ISOFIX/i-Size anchor bars. These anchor bars are located between the seat's cushion and back rest. The exact location of each anchor bar is identified by a marking (illustrated below) located on the seat back, directly above its associated anchor bars.



Adjust until the child restraint system is fitted firmly against the seat back. Ensure the child restraint system fits snugly.



Before seating a child, ensure that the child restraint system is securely installed. Grasp the front of the child restraint system with one hand on each side, and attempt to:

- Twist the child restraint system from side to side.
- Pull the child restraint system away from the seat.

If the child restraint system moves away from the seat, both latches are not fully engaged onto the seat's anchor bars. You must reinstall it and try again. It is critical that both latches on the child restraint system are fully engaged.

WARNING: Do not use ISOFIX anchors with child restraint system or booster seats that have an integral safety belt where the combined weight of the child plus the child restraint system exceeds 33 kg.

Safety Leg

All passenger seats Model Y support the use of a child restraint system with a safety leg. If the child restraint system is equipped with a leg, extend the leg as described in the instructions provided by the manufacturer of the child restraint system.

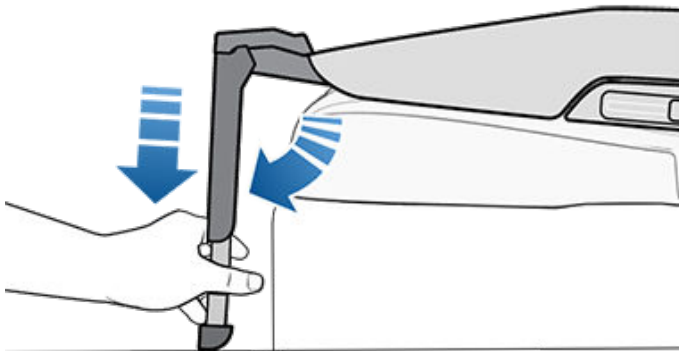

Attaching Upper Tether Straps

Model Y's second row seats support the use of upper tether straps. When the instructions provided by the manufacturer of the child restraint system include attaching an upper tether strap, attach its hook to the anchor point located behind the associated seat.

NOTE: Tighten upper tether straps according to the instructions provided by the manufacturer of the child restraint system.

The anchor points for tether straps are located on the shelf behind the second row seats.

To access an anchor point, press down on the back of its cover.



For dual-strap tethers, position a strap on each side of the head support.





Child Safety Seats

For single-strap tethers at the outboard seating positions, route the strap over the outside-facing side of the head support (same side of the head support as the seat belt retraction mechanism).



If routing the strap over the outside-facing side of the head support is not possible (such as there is not enough slack in the strap), raise the head support (see [#unique_187](#) on page) and route the strap under the head support.

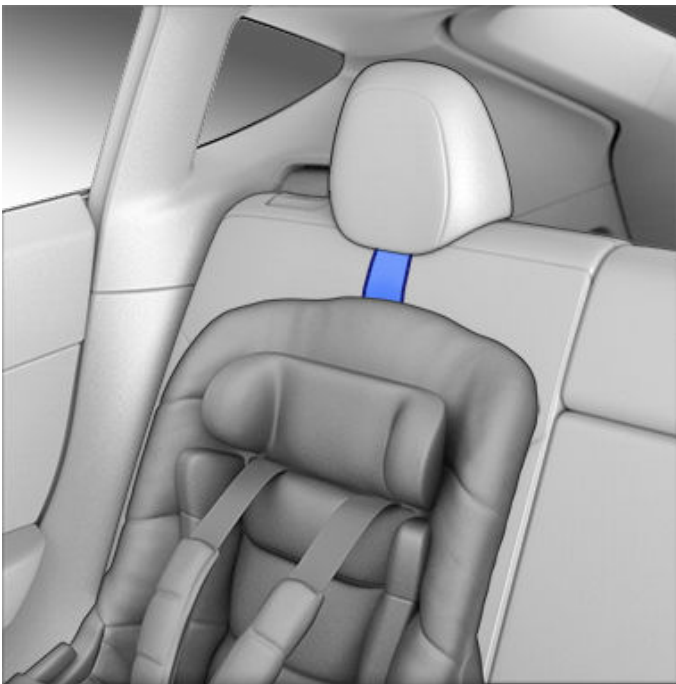



Technical Information

ECE 16-08 Annex 17, Appendix 3, Table 1

	Seat Position Number (see below)				
	1 and 3 Pass Airbag OFF	1 and 3 Pass Airbag ON	4	5	6
Weight Groups Allowed	0, 0+, I, II, III	n/a	0, 0+, I, II, III	0, 0+, I, II, III	0, 0+, I, II, III
Suitable for universal belted?	Yes (Note 1)	No	Yes	Yes	Yes
Suitable for i-Size?	No	No	Yes	No	Yes
Suitable for lateral (L1/L2)?	No	No	No	No	No
Largest suitable rearward-facing ISOFIX (R1/R2X/R2/R3).	No	No	R3 (Note 2)	No	R3 (Note 2)
Largest suitable forward-facing ISOFIX (F1/F2X/F2/F3).	No	No	F3	No	F3
Largest suitable booster seat (B2/B3).	B2	No	B3	No	B3
Suitable for safety leg	Yes	No	Yes	Yes	Yes

Note 1: To accommodate a belt-based child restraint system (CRS) in the front seat, you must raise the seat upward to the mid-height position (~3 cm) and rearward to allow for room between the CRS and the dashboard.

Note 2: To accommodate large ISOFIX child restraint systems (size class C), you may need to move the corresponding front seat forward to the mid-track position (up to 13 cm forward of the rearmost position), raise the seat upward (3 cm from its lowest position), and angle the seat back to 15 degrees (or 10 degrees rearward from its forward-most position).

Note 3: Adult safety belt buckles are not located laterally between ISOFIX anchor bars in any given seat.

Summary of Seat Position Numbers

Seat Position	Location in Vehicle
1	Front Left (RHD vehicles only)
2	Front Center - not applicable to Model Y
3	Front Right (LHD vehicles only)
4	Second Row Left
5	Second Row Center
6	Second Row Right



Child Restraint System Warnings

 **WARNING:** Never seat a child in a rear-facing child restraint system on the front passenger seat when the passenger front airbag is active. Doing so can cause serious injury or death.

 **WARNING:** Some child restraint systems are designed to be secured in vehicle seats by lap belts or the lap belt portion of a lap-shoulder belt. Children could be endangered in a crash if their child restraint systems are not properly secured in the vehicle.

 **WARNING:**

A passenger less than six months old must be restrained in a suitable and properly fastened and adjusted rear-facing approved child restraint system. A passenger six months or older, but less than four years old, must be restrained in a suitable and properly fastened and adjusted:

- rear-facing approved child restraint system; or,
- forward-facing approved child restraint system equipped with a built-in harness.

Infants and small children should ride in a rear-facing child restraint system as long as possible, until they exceed the maximum weight or height permitted by rear-facing child restraint systems.

 **WARNING:** Do not allow a baby or infant to be held on an adult's lap. All children should be restrained in an appropriate child restraint system at all times.

 **WARNING:** To ensure children are safely seated, follow all instructions provided in this document and by the manufacturer of the child restraint system.

 **WARNING:** Children should ride in a rear-facing child restraint system using the seat's integrated 5-point harness for as long as possible until they reach the maximum size or weight limit of the rear-facing child restraint system.

 **WARNING:** When seating larger children, make sure the child's head is supported and the child's seat belt is properly adjusted and fastened. The shoulder portion of the belt must be away from the face and neck, and the lap portion must not be over the stomach.

 **WARNING:** Never attach two child restraint systems to one anchor point. In a collision, one anchor point may be incapable of securing both seats.

 **WARNING:** Child restraint anchor bars are designed to withstand only those loads imposed by correctly fitted child restraints. Under no circumstances are they to be used for adult seat belts, harnesses, or for attaching other items or equipment to the vehicle.

 **WARNING:** Always check harnesses and tether straps for damage and wear.

 **WARNING:** Never leave a child unattended, even if the child is secured in a child restraint system.



WARNING: Never use a child restraint system that has been involved in a collision. Discard the seat and have it replaced as described in the child restraint system manufacturer's instructions.

Location of Airbags

Airbags are located in the approximate areas shown below. Airbag warning information is printed on the sun visors.

Model Y is equipped with an airbag and lap/shoulder belt at both front seating positions. The airbag is a supplemental restraint at those seating positions. All occupants, including the driver, should always wear their seat belts whether or not an airbag is also provided at their seating position to minimize the risk of severe injury or death in the event of a crash.

NOTE: On RHD (Right Hand Drive) vehicles, the locations of the passenger and driver airbags are reversed.

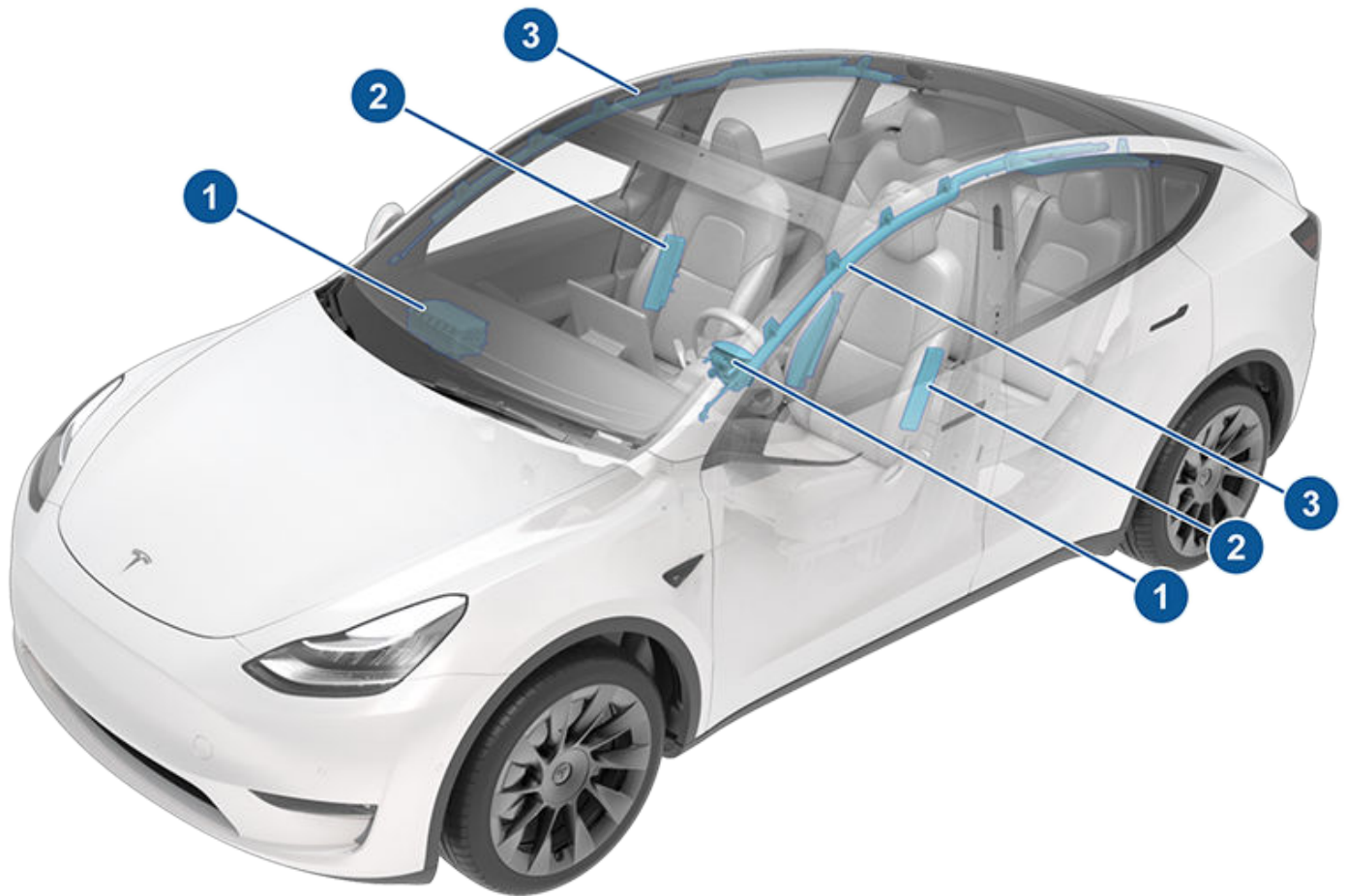

1. Front airbags
2. Seat-mounted side airbags

NOTE: Your vehicle (if equipped, depending on date of manufacture) also has a seat-mounted airbag on the inside portion of the driver's seat.

3. Curtain airbags

How Airbags Work

Airbags inflate when sensors detect an impact that exceeds deployment thresholds. These thresholds are designed to predict the severity of a crash in time for the airbags to help protect the vehicle's occupants. Airbags inflate instantly with considerable force accompanied by a loud noise. The inflated bag, together with the seat belts, limits movement of occupants to reduce the risk of injury.

Front airbags are not ordinarily designed to inflate in rear collisions, rollovers, side collisions and when braking heavily or driving over bumps and potholes. Likewise, front airbags may not inflate in all frontal collisions, such as minor front collisions, underride collisions, or minor impacts with narrow objects (such as posts or poles). Significant superficial damage can occur to the vehicle without the airbags inflating and, conversely, a relatively small amount of structural damage can cause airbags to inflate. Therefore, the external appearance of the vehicle after a collision does not represent whether or not the front airbags should have inflated.

 **WARNING:** Before modifying your vehicle to accommodate a person with disabilities in a way that may affect the airbag system, use the mobile app to schedule a service appointment.

Passenger Front Airbag

Model Y has a passenger front airbag that is always ON. Children must ride in the rear seats only.



The Passenger Airbag On indicator displays in the top corner of the touchscreen to indicate that the passenger front airbag may inflate if a collision occurs.

 **WARNING:** The front passenger seat has an airbag that is always ON. Never seat a child in the front passenger seat, even if using a child restraint system or booster seat. DEATH or SERIOUS INJURY can occur.

Inflation Effects

 **WARNING:** When airbags inflate, a fine powder is released. This powder can irritate the skin and should be thoroughly flushed from the eyes and from any cuts or abrasions.

After inflation, the airbags deflate to provide a gradual cushioning effect for the occupants and to ensure the driver's forward vision is not obscured.

If airbags have inflated, or if your vehicle has been in a collision, your vehicle requires servicing before it will power up. In addition, your airbags, seat belt pre-tensioners and any associated components must be checked, and if necessary, replaced. Use the mobile app to schedule a service appointment immediately.

In a collision, in addition to the airbags inflating:

- Doors unlock.
- Hazard warning lights turn on.
- Interior lights turn on.

Types of Airbags

Model Y has the following types of airbags:

- **Front airbags:** The front airbags are designed to reduce injuries if larger children or adults are riding in the front seats. Follow all warnings and instructions related to seating a child on the front passenger seat (if permitted in your market region).
- **Seat-mounted side airbags:** A seat-mounted side airbag in the front seats helps protect the pelvis and the thorax region of the torso; the seat-mounted far side airbag in the inside portion of the driver's seat helps protect the head and torso. The seat-mounted side airbags on both the impacted and non-impacted side of the vehicle will inflate in the event of severe side impact or severe offset frontal impact.
- **Curtain airbags:** Curtain airbags help protect the head. Curtain airbags on both the impacted and non-impacted side of the vehicle will inflate only if a severe side impact occurs, or if the vehicle rolls over.

- High voltage is disabled.
- Windows go to the vent position.
- Vehicle applies the brakes to come to a stop.

NOTE: Depending on the nature of the impact and the forces involved, doors may not unlock in a collision and/or damage may prevent them from opening. In such cases, the door may need to be opened using the interior manual release, or other means of extrication (for example, exiting through another door, breaking the window, etc.).

NOTE: In some collisions, even if airbags did not inflate, high voltage may be disabled and you will be unable to power up and drive. Use the mobile app to schedule a service appointment immediately.

Airbag Warning Indicator



The airbag indicator on the touchscreen remains lit if the airbag system is malfunctioning. The only time this indicator should light up is briefly when Model Y first powers up, in which case it turns off within a few seconds. If it remains lit, use the mobile app to schedule a service appointment immediately and do not drive.

WARNING: Do not attach or place objects on or near the front airbags, the side of the front seats, the headliner at the side of the vehicle, or any other airbag cover that could interfere with inflation of an airbag. These include but are not limited to: steering wheel covers, decals, seat cushions, pillows, etc. Objects can cause serious injury if the vehicle is in a collision severe enough to cause the airbag to inflate.

WARNING: Following inflation, some airbag components are hot. Do not touch until they have cooled.

Airbag Warnings

WARNING: All occupants, including the driver, should always wear their seat belts, whether or not an airbag is also provided at their seating position, to minimize the risk of severe injury or death in the event of a collision.

WARNING: Front seat occupants should not place their arms over the airbag module, as an inflating airbag can cause fractures or other injuries.

WARNING: Do not use seat covers on Model Y. Doing so could restrict deployment of the seat-mounted side airbags if a collision occurs. It can also reduce the accuracy of the Occupant Classification System (OCS), if equipped.

WARNING: Airbags inflate with considerable speed and force, which can cause injury. To limit injuries, ensure that occupants are wearing seat belts and are correctly seated, with the seat positioned as far back as possible.

WARNING: Children should not be seated on the front passenger seat unless permitted by regulations in your market region. Follow all regulations in your region for the appropriate way to seat a child based on the child's weight, size, and age. The safest place to seat infants and young children is in a rear seating position. Seating an infant or child in a rear-facing child restraint system on a seat equipped with an operational airbag can cause serious injury or death.

WARNING: Do not use a rear-facing child restraint system on a seat with an operational airbag in front of it. Doing so can cause injury or death if the airbag inflates.

WARNING: To ensure correct inflation of the side airbags, maintain an unobstructed gap between an occupant's torso and the side of Model Y.

WARNING: Passengers shouldn't lean their heads against doors or windows. Doing so can cause injury if a curtain airbag inflates.

WARNING: Do not allow passengers to obstruct the operation of an airbag by placing feet, knees or any other part of the body on or near an airbag.



Mobile App

The Tesla mobile app allows you to communicate with Model Y remotely using your iPhone® or Android™ phone.

NOTE: The information below may not represent an exhaustive list of the functions available on the Tesla mobile app. To ensure access to new and improved features, download updated versions of the mobile app as they become available.

To Use the Mobile App

To set up the Tesla mobile app to communicate with your Model Y:

1. Download the Tesla mobile app to your phone.
2. Log in to the Tesla mobile app by entering your Tesla account credentials.
3. Enable mobile access to your Model Y by touching **Controls > Safety > Allow Mobile Access**.
4. Turn your phone's Bluetooth setting **ON** and ensure that Bluetooth is turned on within your phone's global settings for the Tesla mobile app. For example, on your phone, navigate to Settings, choose the Tesla mobile app, and ensure the Bluetooth setting is enabled.

Your phone and vehicle must both be actively connected to cellular service or Wi-Fi for the mobile app to communicate with your vehicle. Tesla recommends that you always have a functional physical key readily available if parking in an area with limited or absent cellular service, such as an indoor parking garage.

NOTE: In the event that you require lockout assistance from Tesla due to a non-warranty issue, such as having limited cellular connectivity and having no secondary key available, your expenses are not covered under the Roadside Assistance policy.

NOTE: Tesla does not support the use of third party applications to contact Model Y.

Overview

When both your phone and the vehicle have internet service, the Tesla mobile app's home screen allows you to:

- Lock or unlock your vehicle.
- Enable or disable the heating or air conditioning and monitor the cabin climate.
- Check your vehicle's charging information. Charging details also appear when a charging cable is plugged in.
- Open or close the charge port.

NOTE: Twisting red lines next to the Battery icon indicate that the Battery is actively heating up (including while charging or preparing to charge).

- See where your vehicle is located.
- View your vehicle's estimated range.

- Open the front trunk.
- View your vehicle's odometer, VIN, and current software version.

Media settings appear on the mobile app to pause, play, rewind, fast forward, and adjust the volume of the media currently playing in the vehicle. You may need to enable Media settings by touching **Audio Settings > Options > Allow Mobile Control**.

For supported video sources, send videos to Tesla Theater by sharing the link through the mobile app. Navigate to the movie, show, or video you want to play on your phone and touch the share button. Share the video with the Tesla app and it appears on the touchscreen if Model Y is in Park.

Profile

In the Profile tab located at the top corner, you can:

- Switch to a different vehicle associated with your Tesla account, if you have access to more than one.
- Navigate the Tesla Shop.
- Manage your account information and view your order history.
- View and customize notifications you receive under the Settings tab, such as Calendar sync, when your security alarm has been triggered, charging updates, and new software updates. You can start updates from afar and check its progress.

Controls

The Controls tab allows you to do the following:

- Open the front or rear trunk.
- Lock or unlock Model Y from afar.
NOTE: Your vehicle does not automatically re-lock if you unlock from the mobile app.
- Open or close the charge port.
- Flash the lights or honk the horn to find where Model Y is parked.
- Enable Keyless Driving.
NOTE: Keyless Driving can be used when you do not have your key or to bypass PIN to Drive in cases where you forgot your PIN or your touchscreen is unresponsive (see [PIN to Drive on page 143](#)).
- Open and close your garage door if your vehicle has a programmed HomeLink connection, if available (see [Smart Garage on page 71](#)).
- Vent the windows.

Climate

You can check the interior temperature and heat or cool the cabin before driving (even if it's in a garage), control the seat heaters, and defrost the windshield:

- Enable or disable **Defrost Car**, which helps melt snow, ice, and frost on the windshield, windows, and mirrors, by swiping up from the bottom of the screen.
- Enable or disable **Dog Mode** or **Camp Mode**.
- Enable **Cabin Overheat Protection**, which prevents the cabin from getting too warm in hot ambient conditions. You can choose whether you want the A/C or just the fan to run when the temperature in the cabin exceeds 40° C or the selected temperature (if available). See [Operating Climate Controls on page 149](#) for more information.
- Vent or close the windows.
- Precondition the cabin to your desired temperature and turn on or off the steering wheel and seat heaters (if equipped).

Using the mobile app to precondition Model Y also warms the Battery as needed. The mobile app will notify you once your vehicle has reached the desired preconditioning temperature.

NOTE: In some vehicles, depending on vehicle specifications and date of manufacture, using the mobile app to defrost Model Y also thaws ice on the charge port latch. This is useful in extremely cold weather or icy conditions in which the charge port latch can freeze in place, preventing you from removing or inserting the charge cable.

Location

Locate Model Y with directions, or track its movement across a map.

Summon

You can park or retrieve Model Y using Summon (see [Summon on page 125](#)) or Smart Summon (see [Smart Summon on page 127](#)).

Schedule

Enable scheduled charging or departure, and precondition the vehicle. See [Scheduled Precondition and Charge on page 178](#) for more information. Scheduled charging or departure can also be saved based on a preferred location.

Security

The Security tab allows you to do the following:

- Pair your phone to the vehicle (see [Phone Key on page 18](#)).

- Enable or disable Sentry Mode (see [How to Use Sentry Mode \(With a USB Flash Drive\) on page 146](#)).
- Enable or disable Valet Mode (see [Valet Mode on page 97](#)).
- Enable or disable Speed Limit Mode and receive notifications when the vehicle's driving speed is within approximately 5 km/h of your selected maximum speed (see [Speed Limit Mode on page 143](#)).

Upgrades

View and purchase the latest upgrades available for your vehicle, such as full self-driving.

Service

See [Schedule Service on page 183](#) for information on how to schedule service through the mobile app.

Roadside

View roadside resources and request roadside assistance (where applicable). For more information on Roadside Assistance, see [Contacting Tesla Roadside Assistance on page 220](#).

Granting Access to a Second Driver

Add and remove access permission for an additional driver from the Tesla mobile app.

NOTE: Tesla mobile app version 4.3.1 or higher is required. Additional drivers can either use a previously registered Tesla Account or use the app to create a new Tesla Account.

To add an additional driver, in the Tesla mobile app from the vehicle home screen, go to **Security > Add Driver** and follow the onscreen instructions.

NOTE: The additional driver has access to all app features except purchasing upgrades.

To remove access, use the mobile app and go to **Security > Manage Drivers** and follow the onscreen instructions.



Wi-Fi

Wi-Fi is available as a data connection method and is often faster than cellular data networks. Connecting to Wi-Fi is especially useful in areas with limited or no cellular connectivity. To ensure fast, reliable delivery of software and map updates, Tesla recommends leaving Model Y connected to a Wi-Fi network whenever possible (for example, when parked at home).

To connect to a Wi-Fi network:

1. Touch **Controls** > **Wi-Fi**. Model Y begins to scan and display detected Wi-Fi networks that are within range.

NOTE: If a known Wi-Fi network does not appear in the list, move Model Y closer to the access point or consider using a range extender.

NOTE: When connecting to a 5GHz network (if available), check which channels are supported in your region.

5GHz Network Channels Supported

36-48	52-64	100-140	149-165
		✓	✓

2. Find and tap the the Wi-Fi network you want to use in **Searching for Wi-Fi Networks** or add it manually in **Add Wi-Fi Networks**, enter the password (if necessary), then touch **Confirm**. When successfully connected, the Wi-Fi network shows in **Known Wi-Fi Networks** along with a green check. Whenever the network is within range, Model Y connects to it automatically.

NOTE: Model Y does not currently support connections to captive Wi-Fi networks (a captive Wi-Fi, commonly used by public hotspots, requires you to access a custom web portal and agree to terms of service prior to allowing you to log in).

NOTE: If more than one previously connected network is within range, Model Y connects to the one most recently used.

NOTE: At Tesla Service Centers, Model Y automatically connects to the Tesla Service Wi-Fi network.

Diagnostics

Diagnostics offers more information on your Wi-Fi connection, as well as connection improvement tips. To access, navigate to **Wi-Fi** > **Diagnostics** or find it below the progress bar while a software update downloads or installs.

Hotspots

Instead of a Wi-Fi network, you can also use a mobile hotspot (subject to fees and restrictions of your carrier). After connecting to your hotspot, select **Remain Connected in Drive**, if you want to keep the connection active while you are driving.

Troubleshooting Tips

If your vehicle's Wi-Fi connection is slow or it fails to connect, try these tips.

- On the touchscreen, check the number of Wi-Fi icon bars (signal strength). If the bars are low, consider adding a Wi-Fi access point closer to the vehicle to improve the signal.
- Restart the touchscreen (see [Restarting the Touchscreen on page 7](#)).
- Remove the Wi-Fi connection and reconnect. Touch **Controls** > **Wi-Fi**, select your network and **Forget Network** then reconnect by touching your network in **Known Networks**.
- Try a different Wi-Fi network.

Bluetooth® Compatibility



You can use various Bluetooth devices in Model Y provided it is paired and within operating range. For example, you can pair your Bluetooth-capable phone so you can use it hands-free. In addition to phones, you can pair other Bluetooth-enabled devices with Model Y. For example, you can pair an iPod Touch, iPad, Android tablet, etc. from which you can play music.

Before using your phone or other Bluetooth device with Model Y, you must pair it. Pairing sets up Model Y to communicate with supported Bluetooth-capable devices. You can pair up to ten Bluetooth phones. Unless you've specified a specific phone as a **Priority Device**, or if the phone specified as **Priority Device** is not within range, Model Y always connects to the last phone that was used (provided it is within range). To connect to a different phone, see [Switching Between Paired Devices on page 68](#).

NOTE: Authenticating your phone to use as a key (see [Keys on page 18](#)) does not allow you to use the phone hands-free, play media from it, etc. You must also pair it as described below.

NOTE: On many phones, Bluetooth turns off if the phone's battery is low.

NOTE: Although Bluetooth typically supports wireless communication over distances of up to approximately nine meters, performance can vary based on the phone, or other device, you are using.

NOTE: Model Y can pair up to twenty Bluetooth devices at a time but only allows two devices to connect simultaneously (such as one phone and one controller or two controllers) to each front and rear touchscreen (if equipped).

 **CAUTION:** Do not leave your paired phone in your vehicle (for example, if you are hiking or at the beach). If you must leave your phone in the vehicle, disable Bluetooth and/or turn the phone off.

Pairing a Phone or Bluetooth Device

Pairing allows you to use your Bluetooth-capable phone hands-free to make and receive phone calls, access your contact list, recent calls, etc. It also allows you to play media files from your phone. Once a phone is paired, Model Y can connect to it whenever the phone is within range.

1. To pair a phone or a Bluetooth device, sit inside Model Y and ensure the touchscreen is on.
2. Unlock your phone and enable Bluetooth (typically in Settings on your phone).

NOTE: On some phones, this may require you to go to Bluetooth Settings for the remainder of the procedure.

3. On the touchscreen, touch **Controls > Bluetooth** to automatically start Bluetooth scanning for new devices.

4. Wait for your phone to be listed and touch **Connect**.
5. Check that the number displayed on your phone matches the number on the touchscreen. Then, on your phone, confirm that you want to pair.
6. If prompted on your phone, specify whether you want to allow Model Y to access your personal information, such as calendar, contacts and media files (see [Importing Contacts and Recent Calls on page 67](#)). When paired, Model Y lists your phone under **Controls > Bluetooth > Paired Devices**.

To change the settings of a paired device, go to **Controls > Bluetooth > Paired Devices** and expand the dropdown next to the device's name.

If you are experiencing issues importing or connecting to Bluetooth, see [Troubleshooting Bluetooth on page 68](#) for more information.

Importing Contacts and Recent Calls

Once a phone is paired, go to **Controls > Bluetooth > Paired Devices** and expand the dropdown next to the device's name to specify whether you want to allow access to your phone's contacts, recent calls and text messages. If you allow access, you can use the phone app to make calls and send messages to people in your list of contacts and on your recent calls list (see [Phone, Calendar, and Web Conferencing on page 69](#)). Before contacts can be imported, you may need to either set your phone to allow syncing, or respond to a popup on your phone to confirm that you want to sync contacts. This varies depending on the type of phone you are using. For details, refer to the documentation provided with your phone.

If you are having trouble importing contacts or pairing with Bluetooth, see [Troubleshooting Bluetooth on page 68](#) for more information.

Disconnecting or Unpairing a Bluetooth Device

If you want to disconnect your phone or Bluetooth device, but keep it paired, touch **Disconnect** in your phone's Bluetooth settings dropdown on the touchscreen (**Controls > Bluetooth > Paired Devices > Your phone**). If you no longer want to use your device with Model Y, touch **Forget Device** and follow the instructions. Once you forget a device, you must pair it again if you want to use it with Model Y (see [Pairing a Phone or Bluetooth Device on page 67](#)).

NOTE: Your phone automatically disconnects when you leave Model Y.

NOTE: Unpairing the phone has no effect on using the phone as a key. To forget an authenticated phone, see [Managing Keys on page 20](#).



Switching Between Paired Devices

Model Y automatically connects to a phone that you designated as **Priority Device**. If you have not set a phone as a priority, Model Y connects to the last phone to which is was connected, provided it is within operating range and has Bluetooth turned on. If the last phone is not within range, it attempts to connect with the next phone that it has been paired with.

To connect to a different phone, touch **Controls > Bluetooth > Paired Devices**. Select the phone you want to connect to, then touch **Connect**. If the phone you want to connect to is not listed, you must pair the phone. See [Pairing a Phone or Bluetooth Device on page 67](#).

When connected, the Bluetooth settings screen displays the Bluetooth symbol next to the phone's name to show that Model Y is connected to the phone.

Troubleshooting Bluetooth

Your vehicle uses Bluetooth and BLE (Bluetooth Low Energy) to seamlessly connect your smartphone to Model Y. Due to several potential factors, Bluetooth or BLE may sometimes disconnect or experience issues in the pairing process. Connecting to Bluetooth allows your vehicle to use phone functions such as audio, phone calls, calendars, text messages, etc.

BLE is used for passive functions like phone key.

NOTE: Do not unpair your vehicle to your phone or remove it as phone key without a working key card nearby.

Try the following to troubleshoot Bluetooth, starting with your smartphone.

Smartphone Troubleshooting

Bluetooth may not connect due to settings and updates on your smartphone:

- Enable Bluetooth on your phone. If already enabled, disable and re-enable Bluetooth again.
- Ensure Airplane Mode is turned off.
- Charge your phone; if your phone battery is too low, it may not support Bluetooth functions.
- Pair your device properly. If already paired, try unpairing and re-pairing again.
- Update your phone to the latest software provided by the manufacturer.
- Check that your vehicle's sound system is selected as the audio output source.
- Ensure your phone's settings allow for Bluetooth (ex: data is turned on or you are connected to Wi-Fi).
- Turn your phone off and on again.

- Ensure location permissions set to "Always On" for the mobile app.

Tesla Mobile App Troubleshooting

Check the Tesla mobile app:

- Confirm the Tesla mobile app is up to date on software.
- Verify you're logged into the Tesla mobile app while using your phone key.
- Ensure the Tesla app is running in the background.
- Double check that you have completely set up your profile in the mobile app and properly configured your settings.

Vehicle Troubleshooting

Your vehicle's settings may affect its ability to pair with your smartphone:

- Charge Model Y: If the vehicle Battery is too low, you may lose Bluetooth function.
- Update vehicle software and make sure it is always up to date. Check for new software updates by navigating to **Controls > Software**.
- Restart the touchscreen. See [Touchscreen on page 5](#).
- Reboot your vehicle.

If Bluetooth still does not work, unpair from your vehicle AND smartphone. Then try re-pairing both again.

For BLE phone key issues, when in the vehicle, navigate to **Controls > Locks** and remove your phone as "Phone as Key". Then set it back up again. But only do this while you are in the vehicle and have a reliable back up key available (such as a key card).



Using the Phone App



When your phone is connected to Model Y using Bluetooth (see [Bluetooth on page 67](#)), and you have allowed access to information on your phone (see [Importing Contacts and Recent Calls on page 67](#)), you can use the phone app to display and make a hands-free call to anyone listed on your phone.

- **Calls:** Displays recent calls in chronological order with the most recent call listed first.
- **Messages:** Displays message in chronological order with the most recent message listed first. You can view, send, and receive text messages. Instead of typing a text message, touch the microphone button on the right side of the steering wheel to enter text using your voice.



WARNING: To minimize distraction and ensure the safety of occupants as well as other road users, do not view or send text messages when the vehicle is in motion. Pay attention to road and traffic conditions at all times when driving.

- **Contacts:** Contacts are listed in alphabetical order and can be sorted by first name or last name. You can also choose a letter on the right side of the list to quickly scroll to the names that begin with the selected character. When you touch a name on your contacts list, the contact's available number(s) displays on the right pane, along with other available information (such as address). Touch the contact's number to make a call.
- **Favorites:** Displays the contacts from your phone that you have identified as Favorites.
- **Calendar:** Displays calendar entries from your phone (see [Calendar on page 69](#)). If an entry includes a phone number or an address, you can make a phone call, or navigate to a destination, by touching the corresponding information in the calendar entry.

Making a Phone Call

You can make a phone call by:

- Speaking a voice command (see [Voice Commands on page 14](#)). Voice commands are a convenient, hands-free way to call or text your contacts.
- Touching a phone number shown in a list in the phone app - Contacts, Calls, or Calendar.
- Using the Model Y on-screen dialer in the Phone app.

NOTE: If it is safe and legal to do so, you can also initiate a call by dialing the number or selecting the contact directly from your phone.

NOTE: You can also make a phone call by touching a pin on the map and choosing the phone number (if available) on the popup screen.

Receiving a Phone Call

When your phone receives an incoming call, the touchscreen displays the caller's number or name (if the caller is in your phone's contact list and Model Y has access to your contacts).

Touch one of the options on the touchscreen to **Answer** or **Ignore** the call. Depending on the phone you are using and what speakers you used for your most recent call, your phone may prompt you to choose which speakers you want to use for the incoming call.



WARNING: Stay focused on the road at all times while driving. Using or programming a phone while driving, even with Bluetooth enabled, can result in serious injury or death.



WARNING: Follow all applicable laws regarding the use of phones while driving, including, but not limited to, laws that prohibit texting and require hands-free operation at all times.

In Call Options

When a call is in progress, the call displays on the touchscreen. To adjust the call volume, roll the left scroll button during a call. Tilt the left scroll button left to mute/unmute and tilt right to end the call.

Calendar



The calendar displays scheduled events from your phone's (iPhone® or Android™) calendar for the current and next day. The calendar is conveniently integrated with the phone app so you can dial into your meeting from a Calendar entry. It is also integrated with the navigation system so you can navigate to the event's location.

1. Ensure your phone is paired to Model Y.
2. Ensure you are logged into the Tesla mobile app.
3. In your Tesla mobile app, touch **Profile > Settings > Calendar Sync**.

NOTE: To ensure you have access to all of the calendar's features, it is recommended that you use the most recent version of the mobile app.

4. On your phone, go to **Settings** and allow access/give permission to share your calendar with the Tesla mobile app. The mobile app can then periodically (and automatically) send calendar data from your phone to Model Y.

If a calendar event includes an address, a navigation arrow displays to indicate that you can touch the address to navigate to the event's location.



Phone, Calendar, and Web Conferencing

If an event has a uniquely specified address and takes place within two hours of you entering your vehicle and preparing to drive, Model Y automatically routes you to the event's address (see [Automatic Navigation on page 161](#)).

Touch an event's information icon to display all notes associated with the event. If the notes include one or more phone numbers, the information icon shows a phone icon and the calendar displays the first phone number found. Touch to initiate a phone call. You can also initiate a phone call by touching any number in an event's notes popup screen (this is especially useful for conference calls). If notes include a web link, you can touch the link to open it in the Web browser.

Zoom



Seamlessly take meetings and calls through your vehicle's touchscreen. To set up, touch the Zoom app and sign in or enter the meeting ID. You can even access meetings shown on your calendar or in text messages by touching the Zoom link. Your vehicle's cabin camera can be used in calls over Zoom only when Model Y is Parked. When the vehicle is shifted out of Park in the middle of a Zoom call, the cabin camera turns off and you switch to audio only. Use the touchscreen to turn on/off the video, mute/unmute yourself, and customize various preferences for your meeting.

 **WARNING:** Do not to use the video function when the vehicle is "temporarily parked" on a public road (such as when the vehicle is parked along the curb or in a spot that is not a designated parking spot)..

 **WARNING:** Stay focused on your surroundings and follow all applicable laws while driving, including, but not limited to, laws that require hands-free operation at all times.



HomeLink Universal Transceiver



If your vehicle is equipped with the HomeLink® Universal Transceiver, you can operate up to three Radio Frequency (RF) devices, including garage doors, gates, lights, and security systems.

NOTE: Depending on date of manufacture, market region, and options selected at time of purchase, some vehicles are not equipped with a HomeLink Universal Transceiver.

WARNING: Do not use the HomeLink Universal Transceiver with a device that does not have safety stop and reverse features. Using a device without these safety features increases the risk of injury or death.

Supported Modes

HomeLink supports three different transmit modes, which is how your vehicle and the RF device communicate. Selecting a transmit mode is determined by your RF device's compatibility:

- **Standard Mode:** Use Standard Mode if your RF device is equipped with a remote control that must be used to operate the device (for example, a remote-controlled garage door). This mode is the most commonly used transmit mode for HomeLink devices.
- **D-Mode or UR-Mode:** Use D-Mode or UR-Mode if the RF device does not have a remote control, and the receiver has a "Learn" button (may also be called "Program" or "Smart"). D-Mode and UR-Mode function similarly in that Model Y communicates directly with the device's receiver as opposed to the remote control.

NOTE: D-Mode is used primarily in North America whereas UR-Mode is popular in Europe, the Middle East, and Asia. To determine the mode your device is compatible with, contact HomeLink by going to www.homelink.com.

Each of your devices can be set to a different mode. For example, your garage door can be set to Standard Mode, your front gate can be set to D-Mode, etc. To change a transmit mode, touch the HomeLink icon at the top of the **Controls** screen and select the device you want to change. Then, select **Program** and choose the desired mode for your device. Confirm by touching **Set Mode** and follow the onscreen instructions.

For older vehicles, changing the mode for one device changes the mode for all devices, so be careful when changing transmit modes. Devices not compatible with your selected mode may not work. Touch the HomeLink icon at the top of the touchscreen, then touch **Change Transmit Mode**.

NOTE: Check the product information for your HomeLink device to determine which mode is compatible with your device.

Programming HomeLink

To program HomeLink®:

1. Park Model Y so that the front bumper is in front of the device you want to program.



CAUTION: Your device might open or close during programming. Therefore, before programming, make sure that the device is clear of any people or objects.

2. Check that the device's remote control has a healthy battery. Tesla recommends replacing the battery in the device's remote control before Programming HomeLink.
3. Touch the HomeLink icon at the top of the **Controls** screen.
4. Touch **Create HomeLink**.
5. On the HomeLink screen, enter a name for the device, then touch **Enter** or **Add New HomeLink**.
6. Choose the mode you wish to use (Standard, D-Mode, or UR-Mode), then touch **Set Mode**.
7. Touch **Start** and follow the onscreen instructions.

NOTE: If you see a screen called "Train the receiver" while programming the device, remember that this is a time-sensitive step. After pressing the Learn/Program/Smart button on the device's remote control, you have only approximately 30 seconds to return to your vehicle and press **Continue**, and then press the trained HomeLink device name twice. Consider having an assistant to ensure you can complete this step within 30 seconds.

8. Once your device is programmed, touch **Save** to complete the programming.
9. Ensure HomeLink works as expected. In some cases, you may need to repeat the programming process multiple times before succeeding.

Once programmed, you can operate the device by touching its corresponding HomeLink icon on the touchscreen. HomeLink remembers the location of your programmed devices. When you approach a known location, the HomeLink control on the touchscreen automatically appears. When you drive away, it disappears.

NOTE: The HomeLink icon displays at the top of the touchscreen when Model Y detects a programmed HomeLink device within range, and the touchscreen is not already displaying the HomeLink screen or popup,

NOTE: For additional assistance or compatibility questions, contact HomeLink (www.homelink.com or call 1-800-355-3515).

Auto Opening and Closing

To operate a HomeLink device without using the touchscreen, you can automate the device to open as you approach, and close as you drive away:



1. Touch the HomeLink icon at the top of the **Controls** screen, touch **HomeLink Settings**, then choose the device you want to automate.
2. Adjust the device's HomeLink settings as needed:
 - o Select the **Auto-open when arriving** checkbox if you want the device to open as you approach.
 - o Touch the arrows to specify the distance you want Model Y to be from the device before it opens.
 - o Select the **Auto-close when leaving** checkbox if you want the device to close as you drive away.
 - o Select the **Auto-fold mirrors** checkbox if you want mirrors to fold when you arrive at the HomeLink location. This is useful for narrow garages.
 - o Select the **Chime for Auto-open and Auto-close** checkbox if you want Model Y to sound a chime when a signal has been sent to open or close the device.

HomeLink remembers the vehicle's GPS location at the time of pairing and uses this to determine the vehicle's whereabouts in relation to the HomeLink device. HomeLink does not detect and differentiate between opening and closing (ex: if Auto-open is triggered and the door is already open, the door will close) but typically determines whether to auto-open or -close based on the following:

Auto-Open: Detects when Model Y approaches the garage door (or other HomeLink device) within a specified distance. Auto-open initiates so long as the approaching vehicle is in Drive and HomeLink is enabled. HomeLink does not trigger when the vehicle is already in the area.

Auto-Close: HomeLink triggers when the Model Y shifts from Park into Reverse, and moves at least seven meters in Reverse.

NOTE: Changing gears multiple times while in the specified distance may interfere with Auto-close.

In situations where you don't want the device to automatically open or close, touch **Skip Auto-Open** or **Skip Auto-Close** at any time during the count-down message.

NOTE: Do not rely on HomeLink to ensure the device fully closes.

Resetting the Location of the HomeLink Device

If you experience situations in which you sometimes drive up to your HomeLink device and it doesn't open, or the touchscreen does not display a notification as you approach a programmed device, you may need to reset the device's location. To do so, park as close as possible to the HomeLink device (garage door, gate, etc.) and display the HomeLink settings page by touching the HomeLink icon at the top of the **Controls** screen. Touch the name of the device you want to reset, then touch **Reset Location**.

Deleting a Device

To delete a HomeLink device, touch the HomeLink icon at the top of the **Controls** screen, then touch **HomeLink Settings**. Touch the name of the device you want to delete, then touch **Delete**.

NOTE: You can also perform a factory reset to erase your HomeLink settings, along with all other personal data (saved addresses, music favorites, imported contacts, etc.). See [Erasing Personal Data with a Factory Reset on page 8](#).

NOTE: For security reasons, delete your HomeLink devices if you sell your Model Y.

Troubleshooting HomeLink

Standard Mode

In Standard Mode, Model Y records the RF signal from your HomeLink device's remote control. The touchscreen instructs you to stand in front of the vehicle, point the device's remote control at the front bumper, and press and hold the button until the headlights flash. When the headlights flash, Model Y has learned the remote control and you can touch **Continue** on the touchscreen. If the headlights do not flash:

- Check the batteries in the remote control. It is a good idea to replace the batteries before you start programming.
- Ensure you are standing in front of Model Y with the device's remote control positioned within five cm of the Tesla emblem.
- Press and hold the button on your device's remote control until the headlights flash. In some cases you must hold the button on the remote control for up to three minutes.

NOTE: Some HomeLink remote controls require multiple short presses (approximately one second each press) instead of one long duration press. If you are unsuccessful after multiple attempts of using long presses, try repeated presses of one second each.

D-Mode and UR-Mode

In D-Mode and UR-Mode, the device's receiver learns Model Y. The touchscreen instructs you to press the "Learn" button (may also be called "Program" or "Smart") on the device's receiver. If this does not work, refer to the following guidelines:

- Park Model Y with its bumper as close as possible to the garage door, gate, etc. that you are trying to program.
- Make sure you are pressing the receiver's Learn/Program/Smart button. For instructions on how to put the receiver into learning mode, refer to the product details provided with your RF device that you are trying to program.



- If you see a screen called "Train the receiver" while programming the device, remember that this is a time-sensitive step. After pressing the Learn/Program/Smart button on the device's remote control or receiver, you only have approximately 30 seconds to return to your vehicle, press **Continue**, then press the trained HomeLink device name twice. Consider having someone assist you with this step.
- Most devices stay in learning mode for only three to five minutes. Immediately after pressing the device's Learn/Program/Smart button, follow the instructions displayed on the vehicle's touchscreen.

For additional assistance or compatibility questions, contact HomeLink (www.homelink.com or call 1-800-355-3515).



Starting and Powering Off

Starting

When you open a door to enter Model Y, the touchscreen powers on and you can operate all controls. To drive Model Y:

1. **Press the brake pedal** - Model Y powers on and is ready to drive.
2. **Select a drive mode** - move the drive stalk down for Drive or up for Reverse (see [Shifting on page 79](#)).

NOTE: If the **PIN to Drive** feature is enabled (see [PIN to Drive on page 143](#)), you must also enter a valid PIN on the touchscreen before you can drive Model Y.

Everything you need to know when driving Model Y displays on the touchscreen.

Drive Disabled - Requires Authentication

If Model Y does not detect a key when you press the brake (a key fob or phone key is not detected or two minutes have passed since you used the key card), the touchscreen displays a message telling you that driving requires authentication.

If you see this message, place the key card behind the cup holders where the RFID transmitter can read it. The two-minute authentication period restarts and you can start Model Y by pressing the brake pedal.

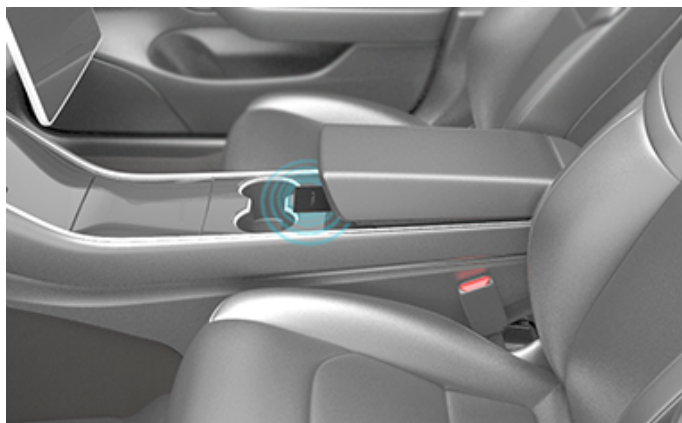

A number of factors can affect whether Model Y can detect a phone key or key fob (for example, the device's battery is low or dead and is no longer able to communicate using Bluetooth).

Always keep your phone key, key fob, or a key card with you. After driving, your key is needed to restart Model Y after it powers off. And when you leave Model Y, you must bring your key with you to lock Model Y, either manually or automatically.

Powering Off

When you finish driving, shift into Park by pressing the button on the end of the drive stalk. When you leave Model Y with your phone key and key fob, it powers off automatically, turning off the touchscreen.

Model Y also powers off automatically after being in Park for 30 minutes, even if you are sitting in the driver's seat.

Although usually not needed, you can power off Model Y while sitting in the driver's seat, provided the vehicle is not moving. Touch **Controls > Safety > Power Off**. Model Y automatically powers back on again if you press the brake pedal or touch the touchscreen.

NOTE: Model Y automatically shifts into Park whenever it determines that you are exiting the vehicle (for example, the driver's seat belt is unbuckled and the vehicle is almost at a standstill). If you shift into Neutral, Model Y shifts into Park when you open the door to exit. To keep Model Y in Neutral, you will need to activate Transport Mode (see [Instructions for Transporters on page 217](#)).

Power Cycling the Vehicle

You can power cycle Model Y if it demonstrates unusual behavior or displays a nondescript alert.

NOTE: If the touchscreen is unresponsive or demonstrates unusual behavior, reboot it before you power cycle the vehicle (see [Restarting the Touchscreen on page 7](#)).

1. Shift into Park.
2. On the touchscreen, touch **Controls > Safety > Power Off**.
3. Wait for at least two minutes without interacting with the vehicle. Do not open the doors, touch the brake pedal, touch the touchscreen, etc.
4. After two minutes, press the brake pedal or open the door to wake the vehicle.



Adjusting the Steering Wheel Position

To adjust the steering wheel, touch **Controls** and touch the **Steering** icon.

Use the left scroll button on the steering wheel to move the steering wheel to the desired position:

- To adjust the height/tilt angle of the steering wheel, roll the left scroll button up or down.
- To move the steering wheel closer to you, or further away from you, press the left scroll button to the left or right.

You can also customize what you want the left scroll button to control, such as Climate or Dashcam status. To customize, hold down the left scroll button and navigate the menu on the touchscreen.

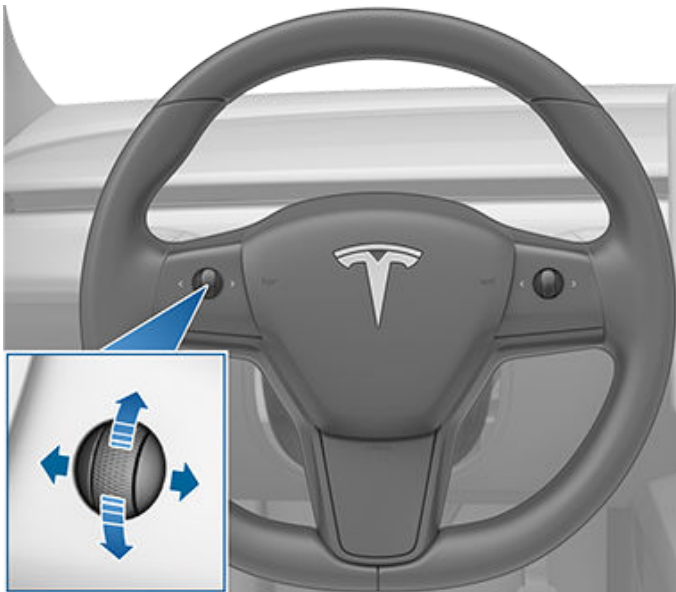

WARNING: Do not make steering wheel adjustments while driving.

Adjusting Steering Weight

You can adjust the feel and sensitivity of the steering system to suit your personal preference:

1. On the touchscreen, touch **Controls** > **Dynamics** > **Steering Weight**.
2. Choose a steering option:
 - **Light** - Reduces the effort required to turn the steering wheel. In town, Model Y feels easier to drive and park.
 - **Medium** - Tesla believes that this setting offers the best handling and response in most conditions.
 - **Heavy** - Increases the effort required to turn the steering wheel. When driving at higher speeds, Model Y feels more responsive.

Scroll Buttons

A scroll button is located on each side of the steering wheel. Use your thumb to press this button to the right or left. You can also press the button or roll it up or down.

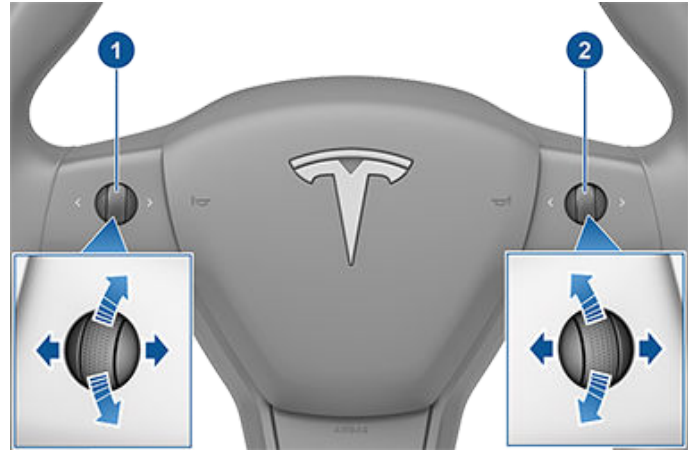

1. Use the left scroll button to:

- Control the volume. Press the scroll button to mute/unmute the volume, roll the scroll button up to increase the volume or down to decrease the volume.

NOTE: The scroll button adjusts the volume for media, navigation instructions or phone calls based on what is currently in use. As you adjust volume, the touchscreen displays the volume level and whether you are adjusting volume for media, navigation or phone calls.

- Push the scroll button to the right to go to the next song, station, or Favorite (depending on what's playing). Push the scroll button to the left to return to the previous selection.
- Adjust the position of the exterior mirrors (see [Adjusting Exterior Mirrors on page 77](#)).
- Adjust the position of the steering wheel (see [Adjusting the Steering Wheel Position on page 75](#)).
- Adjust the angle of the headlights (see [Headlight Adjustments on page 82](#)).

2. Use the right scroll button to:

- Speak a voice command. Press the button to initiate a voice command (see [Voice Commands on page 14](#)).
- When using Traffic-Aware Cruise Control, adjust your set speed and the distance you want to maintain from a vehicle traveling ahead of you (see [Traffic-Aware Cruise Control on page 108](#)).

NOTE: The arrows associated with the scroll buttons are backlit in low ambient lighting conditions. To turn this backlighting on or off, touch **Controls** > **Lights** > **Steering Wheel Lights**.

To restart the touchscreen, press and hold both scroll buttons until after the touchscreen turns black. See [Restarting the Touchscreen on page 7](#).



Steering Wheel

Heated Steering Wheel

To warm up the steering wheel, touch the fan icon on the touchscreen to display climate controls (see [Adjusting Climate Control Settings on page 149](#)), then touch the steering wheel icon. When on, radiant heat keeps the steering wheel at a comfortable temperature.

NOTE: Depending on date of manufacture, your Model Y may not be equipped with a heated steering wheel.

Horn

To sound the horn, press and hold the center pad on the steering wheel.

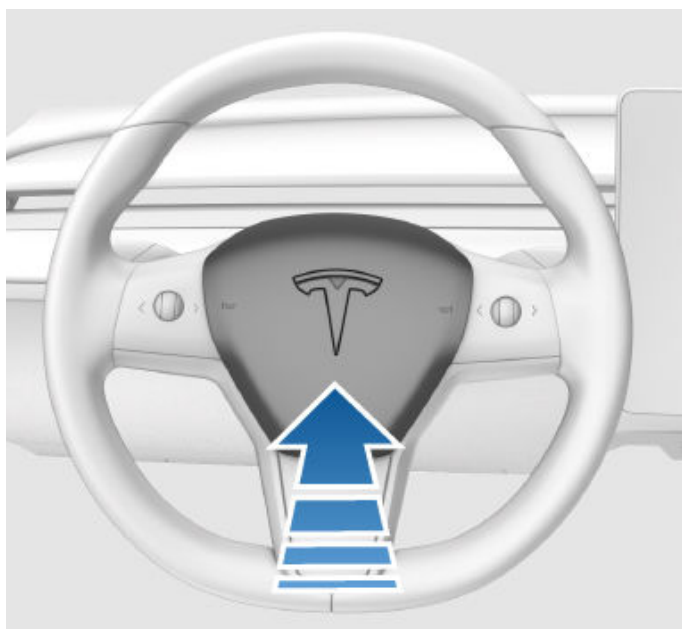

Adjusting Exterior Mirrors

Adjust the exterior mirrors by touching **Controls > Mirrors**. Press the left scroll button on the steering wheel to choose whether you are adjusting the **Left** or **Right** mirror. Then use the left scroll button as follows to adjust the selected mirror to its desired position:

- To move the mirror up or down, roll the left scroll button up or down.
- To move the mirror inward or outward, press the left scroll button to the left or right.

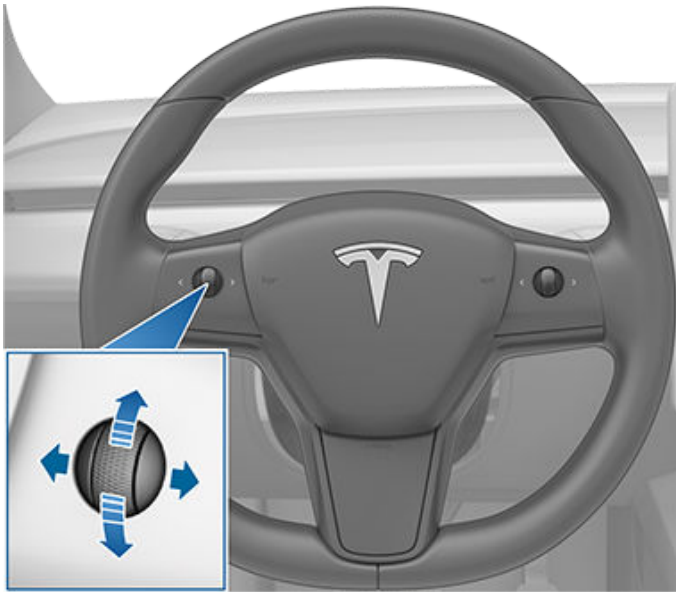

Both exterior mirrors can tilt downward when the vehicle is shifted into Reverse. To turn this feature on or off, touch **Controls > Mirrors > Mirror Auto Tilt**. To adjust the auto-tilt position, touch **Adjust Tilted Position** and make mirror adjustments as needed. After adjusting the tilted position and touching **Save**, mirrors will automatically tilt to the configured position whenever you shift into Reverse. When you shift out of Reverse, mirrors tilt back to their normal (upward) position. **Mirror Auto Tilt** must be enabled to adjust tilted position.

To reduce glare when driving at night, the rear view mirror and exterior side mirrors dim automatically. To enable or disable this feature, touch **Controls > Mirrors > Mirror Auto Dim**.

Availability of **Mirror Auto Dim** depends on configuration, market region, and date of manufacture.

NOTE: Both exterior mirrors have heaters that turn on and off with the rear window defroster.

Folding Mirrors

To manually fold and unfold exterior mirrors (for example, parking in a narrow garage, tight space, etc.), touch **Controls > Fold/Unfold Mirrors**. You can also fold and unfold mirrors using the multifunction capabilities on your left scroll wheel.

When you manually fold the mirrors, they remain folded until your driving speed reaches 50 km/h (or until you manually unfold them by touching **Controls > Unfold Mirrors**).

NOTE: You cannot fold a mirror when driving over 50 km/h.

To set the mirrors to fold automatically whenever you exit and lock Model Y touch **Controls > Mirrors > Mirror Auto Fold**. The mirrors unfold automatically when you unlock Model Y.

You can also set mirrors to fold automatically whenever you arrive at a specific location, which saves you from having to manually fold them each time you arrive at a frequented place. To set up, stop at the location you want to save (or drive at less than 6 km/h), and fold the mirrors. Touch **Save Location** when it appears briefly on the **Fold Mirrors** control.

If you no longer want mirrors to automatically fold, touch **Controls > Unfold Mirrors** when they fold at the saved location and then touch **Remove Location**.

When you leave the saved location, mirrors unfold when your driving speed reaches 6 km/h, or when you touch **Controls > Unfold Mirrors**.

NOTE: Mirrors can automatically fold if you return to a saved location and are driving below 50 km/h.

NOTE: You can override the automatic folding/unfolding of mirrors at any time (for example, Model Y has no power) by pushing the mirror assembly away from you to unfold, or pulling it toward you to fold.

NOTE: If you expect ice to accumulate when Model Y is parked, turn off **Mirror Auto Fold**. Accumulation of ice can prevent exterior side mirrors from folding or unfolding. See [Cold Weather Best Practices on page 155](#) for information on how to ensure your mirrors function properly in cold weather.

You can integrate auto-folding mirrors with HomeLink (see [Smart Garage on page 71](#)). To enable, go to **HomeLink > Auto-Fold Mirrors when Nearby**.

Rear View Mirror

Adjust the rear view mirror manually. When in Drive or Neutral, the rear view mirror automatically dims in low lighting conditions based on the time of day (for example, when driving at night).

Vanity Mirrors

To expose and illuminate the vanity mirror, fold the sun visor downwards, then use the tab to lower the mirror cover. After closing the mirror cover, the light turns off.



Mirrors

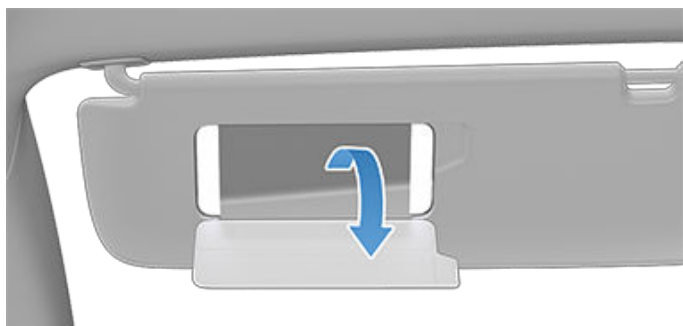

How to Shift

When Model Y is in Park, you must press the brake pedal to shift.

Move the drive stalk up or down to shift into different drive modes. A chime sounds whenever you shift gears.



If you try to shift when it is prohibited by the current driving speed, a chime sounds and the drive mode does not change.

If you want to disable chime sounds when you shift gears, touch **Controls > Safety > Gear Chimes**.

Reverse

Push the drive stalk all the way up and release. You can only shift into Reverse when Model Y is stopped or moving less than 8 km/h.

Neutral

Neutral allows Model Y to roll freely when you are not pressing the brake pedal:

- When in Park, shift into Neutral by briefly pushing the drive stalk either up or down to the first position.
- When in Drive, shift into Neutral by briefly pushing the drive stalk up to the first position. If Autosteer or Traffic-Aware Cruise Control (if equipped) is active, you must push the drive stalk up to the first position and hold it there for more than 1 second. In doing so, Autosteer or Traffic-Aware Cruise Control is disabled.
- When in Reverse, shift into Neutral by briefly pushing the drive stalk down to the first position.

NOTE: You must press the brake pedal to shift out of Neutral if driving slower than approximately 8 km/h.

Model Y automatically shifts into Park when you leave the driver's seat. To stay in Neutral, use the touchscreen to engage Transport Mode (see [Instructions for Transporters on page 217](#)).

Drive

Push the drive stalk all the way down and release. You can shift into Drive when Model Y is stopped or moving less than 8 km/h in Reverse.

NOTE: When in Drive, push the drive stalk all the way down once to engage Traffic-Aware Cruise Control, or twice in quick succession to engage Autosteer. If **Autopilot Activation** is set to **Single Pull**, pulling the drive stalk down once activates Autosteer (which includes Traffic-Aware Cruise Control). Touch **Controls > Autopilot > Autopilot Activation** and choose **Double Pull** to use Traffic-Aware Cruise Control independently of Autosteer when you pull the drive stalk down once. For more information, see [Autopilot Settings on page 108](#).

Park

Press the end of the drive stalk while Model Y is stopped.



Model Y automatically shifts into Park to prevent roll-away while driving in low speeds. This happens whenever you connect a charge cable, unbuckle your seat belt, or open the door while in Drive or Neutral. Ensure the charge cable is removed, buckle your seat belt, and close the door before shifting out of Park.

Attempting to engage the parking brake above 8 km/h will result in emergency braking (see [Emergency Braking on page 85](#)).

To make it convenient to pick up passengers, you can also unlock all doors at any time by shifting into Park then pressing the Park button a second time.

NOTE: You must press the brake pedal to shift out of Park.

NOTE: The above conditions do not reflect a comprehensive list of reasons why Model Y may or may not automatically shift into Park and, in certain scenarios, it is possible for your vehicle to shift into Park when only one of the above conditions is true.



Shifting

 **CAUTION:** Model Y will not shift out of Park if the front trunk is not securely shut or if the charge port is unable to determine whether a charging cable is plugged in. Ensure the front trunk is closed and any charging cables are unplugged, and follow the directions on the touchscreen to proceed.

 **CAUTION:** In emergency situations, if the brakes are not functioning properly, press and hold the Park button on the drive stalk to bring Model Y to a stop. Do not use this method to stop the vehicle unless absolutely necessary.

 **WARNING:** It is the driver's responsibility to always ensure the vehicle is in Park before exiting. Never rely on Model Y to automatically shift into Park for you; it might not work in all circumstances (for example, if Creep or a slope causes the vehicle to travel greater than approximately 2 km/h).

Controlling Lights



Touch **Controls** > **Lights** on the touchscreen to access all light controls, both interior and exterior.

You can also pull the turn signal stalk toward you to display a popup that provides quick access to exterior lights. For example, you can turn the headlights on or off continuously (overriding the default Auto High Beam setting). The lights popup allows you to adjust all exterior light settings, including parking lights, fog lights (if equipped), etc. The setting you choose is retained for the current drive only.

NOTE: If the touchscreen is already displaying the full Controls screen for lights, pulling the turn signal stalk does not display the quick access popup.

In addition to the lights you can control from the touchscreen, Model Y has convenience lights that operate automatically based on what you are doing. For example, in low ambient lighting conditions, the interior lights, marker lights, tail lights, and puddle lights turn on when you unlock Model Y, when you open a door, and when you shift into Park. They turn off after a minute or two, when you shift or lock Model Y. Use these settings to control your vehicle's interior and exterior lights:

Headlights

Exterior lights (headlights, tail lights, position lights and license plate lights) are set to **Auto** each time you start Model Y. When set to **Auto**, exterior lights automatically turn on when driving in low lighting conditions. If you change to a different setting, lights always revert to **Auto** on your next drive.

Touch one of these options to change and retain the exterior light setting until adjusted again or the next time you drive:

OFF Exterior lights turn off. When driving, daytime running lights may remain on based on regulations in various market regions.



Parking lights, side marker lights, tail lights and license plate lights turn on.



Low beam headlights, side marker lights, parking lights, tail lights, and license plate lights turn on.

NOTE: Model Y has a series of LED lights along the rim of the headlights, also referred to as "signature" lights. These lights automatically turn on whenever Model Y is powered on and a drive mode (Drive or Reverse) is engaged.

CAUTION: The rear tail lights are off when daytime running lights are on. Be sure the rear lights are on during low rear visibility conditions (for example, when it is dark, foggy, snowy, or the road is wet, etc.). Failure to do so can cause damage or serious injury.

WARNING: Always ensure that headlights are on during low visibility conditions. Failure to do so may result in a collision.

Fog Lights

A separate control is available to turn on fog lights (if equipped). When on, fog lights operate whenever low beam headlights are on. When headlights are turned off, fog lights also turn off.

Dome Lights

Turn the interior dome (map) lights on or off. If set to **AUTO**, the interior dome lights turn on when you unlock Model Y, open a door upon exiting, or shift into Park.



You can also manually turn an individual dome light on or off by pressing its lens. If you manually turn a dome light on, it turns off when Model Y powers off. If Model Y was already powered off when you manually turned the light on, it eventually turns off.

NOTE: To control the backlighting on the steering wheel buttons, touch **Controls** > **Lights** > **Steering Wheel Lights**. If on, they turn on whenever headlights are on.

Ambient Lights

When enabled, interior ambient lights (if equipped) turn on whenever the headlights are on.

Steering Wheel Lights

If you turn on **Steering Wheel Lights**, the arrows associated with the scroll buttons are backlit in low ambient lighting conditions.

Reading Lights

There are two reading lights in the second row seating area, both above the door and next to the coat hangers (see [Coat Hangers on page 29](#)). Turn an individual reading light on or off by pressing its lens. The reading light will automatically turn off when Model Y powers off.



High Beam Headlights

You can temporarily turn on high beams by pulling the turn signal stalk toward you. When you release, high beam headlights turn off.

To briefly flash the high beam headlights, pull the turn signal stalk towards you and immediately release.

By default, **Adaptive Headlights** is enabled to allow high beam headlights to automatically adjust based on whether or not Model Y detects a vehicle approaching from the opposite direction.



NOTE: Your chosen setting is retained until you manually change it.

The following indicator lights are visible on the touchscreen to show the status of the headlights:



Low beam headlights are on.



High beam headlights are on and **Adaptive Headlights** is disabled or currently unavailable.



Adaptive Headlights is enabled and high beams are on. Model Y is ready to turn off the high beams if light is detected.



Adaptive Headlights is enabled but high beams are not on because light is detected in front of Model Y. When light is no longer detected, high beams automatically turn back on.

Adaptive Headlights

When **Adaptive Headlights** is enabled, the beam of the headlights adjusts automatically to improve your driving view. For example, when traffic is approaching Model Y and the high beam headlights are on, individual pixels of the high beam headlights dim to reduce glare.

Likewise, when the low beam headlights are on and you are driving on a highway, the headlights adjust to illuminate more of the road.

The headlights also adjust to curves on the road ahead to provide greater visibility at night.

To control this feature, touch **Controls > Lights > Adaptive Headlights**, or by using the lights popup that displays on the touchscreen when you pull the turn signal stalk toward you.

NOTE: **Adaptive Headlights** is automatically enabled when Autosteer is engaged. To switch to low beam headlights, push the turn signal stalk forward and release. **Adaptive Headlights** is re-enabled every time Autosteer is activated.

WARNING: **Adaptive Headlights** is a convenience feature only and is subject to limitations. It is the driver's responsibility to make sure that headlights are always appropriately adjusted for weather conditions and driving circumstances.

Headlights After Exit

When **Headlights after Exit** is on, the exterior headlights remain on when you stop driving and park Model Y in low lighting conditions. They automatically turn off after one minute or when Model Y locks. When off, headlights turn off when you engage Park and open a door.

NOTE: If you lock Model Y using the Tesla mobile app or key card, the headlights immediately turn off. However, if the vehicle locks because Walk-Away Door Lock is enabled (see [Walk-Away Door Lock on page 22](#)), the headlights automatically turn off after one minute.

To turn this feature on or off, touch **Controls > Lights > Headlights after Exit**.

Headlight Adjustments

To adjust the angle of the headlights, touch **Controls > Service > Adjust Headlights**, then follow the onscreen instructions. You can choose which headlight you would like to adjust by selecting it on the touchscreen.

NOTE: Headlights do not require adjustments when temporarily driving into a region where the traffic direction is different (for example, driving in right-hand traffic region, and then driving into a region with left-hand traffic).

⚠ WARNING: Proceed with caution when adjusting headlights. Tesla has carefully calibrated the position of the headlights to be in an optimum position for most driving scenarios. Tesla recommends that you do not adjust headlights unless you are familiar with how headlights should be adjusted. Once adjusted, you will be unable to automatically restore them to their originally calibrated position. Contact Tesla for assistance when adjusting headlights.

Turn Signals

The turn signals flash three times or continuously, depending on how far up or down you move the stalk. Lightly push the turn signal stalk up or down for a three-flash sequence. For a continuous signal, push the stalk fully up or down.

The turn signals stop operating when canceled by the steering wheel, by moving the stalk in the opposite direction, or lightly pushing the stalk in the same direction once more.

If **Controls > Lights > Automatic Turn Signals** is set to **Auto Cancel**, turn signals cancel automatically when Model Y detects completion of a maneuver such as a merge, lane change, or a fork in the roadway. If **Automatic Turn Signals** is set to **Off**, you must cancel the turn signal manually by using the turn stalk.



The corresponding turn signal indicator lights up on the touchscreen when a turn signal is operating. Model Y also emits a clicking sound.

⚠ WARNING: When actively using Traffic-Aware Cruise Control, engaging a turn signal can cause Model Y to accelerate in specific situations (see [Overtake Acceleration on page 114](#)).

⚠ WARNING: When actively using Autosteer, engaging a turn signal can cause Model Y to change lanes (see [Autosteer on page 109](#)).

Hazard Warning Flashers

To turn on the hazard warning flashers, press the button located above the rear view mirror. All turn signals flash. Press the button again to turn off the hazard warning flashers.



NOTE: The hazard warning light button is illuminated whenever Model Y is powered on.

Condensation in Head or Tail Lights

Due to weather changes, humidity levels, or recent exposure to water (such as a car wash), condensation may occasionally accumulate in your vehicle's head or tail lights. This is normal — as the weather gets warmer and humidity decreases, condensation often disappears on its own. If you notice water buildup within the exterior lenses, or if the condensation affects the visibility of the exterior lights, contact Tesla Service.



Wipers and Washers

Wipers

You can access wiper settings by pressing the button on the end of the turn signal stalk or touching **Controls > Wipers**.

You can also add wipers to the bottom bar (see [Customizing My Apps on page 6](#)).

The button at the end of turn signal stalk has two levels.

- *Press partially* to wipe the windshield. If the wiper is already operating at a wiper setting and is not set to **Auto**, pressing the button cycles through speeds. Wiper speeds cycle as follows: I > II > III > IIII > III > II > I.
- *Press fully* to spray washer fluid onto the windshield. After releasing the button, the wipers perform two additional wipes then, depending on vehicle and environmental conditions, a third wipe a few seconds later. You can also press and hold the wiper button for a continuous spray of washer fluid—the wipers perform the wipes after you release.

Whenever you press the wiper button, the touchscreen displays the wiper menu, allowing you to adjust wiper settings. Roll the left scroll button on the steering wheel up or down to choose your desired setting. You can also use the touchscreen or use voice commands (see [Voice Commands on page 14](#)).

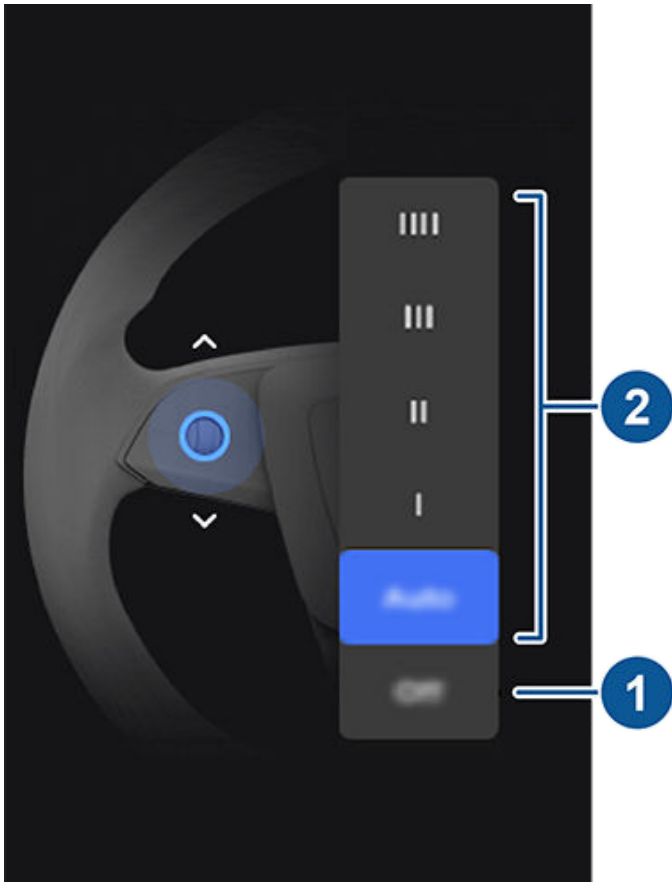

1. Turn the wiper off.
2. Choose how you want the wipers to operate:

- IIII - Continuous, fast.
- III - Continuous, slow.
- II - Intermittent, fast.
- I - Intermittent, slow.
- **Auto** - Model Y detects precipitation and adjusts the wiping speed and intensity. Pressing the wiper button while the wipers are set to **Auto** temporarily increases the sensitivity of the wipers.

NOTE: When you engage Autosteer the wipers are set to **Auto**. Although you can change the wiper setting from **Auto** while using Autosteer, the wipers once again default to **Auto** the next time you engage Autosteer.

NOTE: The Auto setting is currently in BETA. If uncertain about using the Auto setting while in the BETA phase, Tesla recommends operating the wipers manually, as necessary.

Periodically check and clean the edge of the wiper blades. If a blade is damaged, replace it immediately. For details on checking and replacing wiper blades, see [Windshield Wiper Blades, Jets and Fluid on page 196](#).

- ⚠ **CAUTION:** Ensure the wipers are off before washing Model Y to avoid the risk of damaging the wipers.
- ⚠ **CAUTION:** To avoid damaging the hood, ensure that the hood is fully closed before using the windshield wipers.
- ⚠ **CAUTION:** In harsh climates, ensure that the wiper blades are not frozen or adhered to the windshield. Remove ice from the windshield before using the wipers. Ice has sharp edges that can damage the rubber on the blades.

Windshield Washers

Press the button on the end of the turn signal stalk to spray washer fluid onto the windshield. This button has two levels. Press partially for a single wipe without any washer fluid. Press fully for both wipe and wash. When washing the windshield, the wipers turn on. While spraying the windshield, the wipers turn on. After releasing the button, the wipers perform two additional wipes then, depending on vehicle and environmental conditions, a third wipe a few seconds later.



Periodically top up washer fluid (see [Topping Up Windshield Washer Fluid on page 196](#)).



Braking Systems

WARNING: Properly functioning braking systems are critical to ensure safety. If you experience a problem with the brake pedal, brake calipers, or any component of a Model Y braking system, contact Tesla immediately.

Model Y has an anti-lock braking system (ABS) that prevents the wheels from locking when you apply maximum brake pressure. This improves steering control during heavy braking in most road conditions.

During emergency braking conditions, the ABS constantly monitors the speed of each wheel and varies the brake pressure according to the grip available.

The alteration of brake pressure can be felt as a pulsing sensation through the brake pedal. This demonstrates that the ABS is operating and is not a cause for concern. Keep firm and steady pressure on the brake pedal while experiencing the pulsing.



The ABS indicator briefly flashes amber on the touchscreen when you first start Model Y. If this indicator lights up at any other time, an ABS fault has occurred and the ABS is not operating. Contact Tesla. The braking system remains fully operational and is not affected by an ABS failure. However, braking distances may increase. Drive cautiously and avoid heavy braking.



If the touchscreen displays this red brake indicator at any time other than briefly when you first start Model Y, a brake system fault is detected, or the level of the brake fluid is low. Contact Tesla immediately. Apply steady pressure and keep the brakes firm to bring the vehicle to a stop when safe to do so.



The touchscreen displays this amber brake indicator if a brake booster fault is detected. Apply steady pressure and keep the brakes firm to stop the vehicle when safety permits. Hydraulic Boost Compensation will be active (see [Hydraulic Boost Compensation on page 86](#)).

Emergency Braking

In an emergency, fully press the brake pedal and maintain firm pressure, even on low traction surfaces. The ABS varies the braking pressure to each wheel according to the amount of traction available. This prevents wheels from locking and ensures that you stop as safely as possible.

If an alternative method is needed to bring the vehicle to a stop, press and hold the Park button on the drive stalk to apply the brakes and remove drive torque while the button is held.

WARNING: Do not pump the brake pedal. Doing so interrupts operation of the ABS and can increase braking distance.

WARNING: Always maintain a safe distance from the vehicle in front of you and be aware of hazardous driving conditions. While the ABS can improve stopping distance, it cannot overcome the laws of physics. It also does not prevent the danger of hydroplaning (where a layer of water prevents direct contact between the tires and the road).

CAUTION: Automatic Emergency Braking (see [Collision Avoidance Assist on page 137](#)) may intervene to automatically brake in situations where a collision is considered imminent. Automatic Emergency Braking is not designed to prevent a collision. At best, it can minimize the impact of a frontal collision by attempting to reduce your driving speed. Depending on Automatic Emergency Braking to avoid a collision can result in serious injury or death.

CAUTION: In emergency situations, if the brakes are not functioning properly, press and hold the Park button on the drive stalk to bring Model Y to a stop. Do not use this method to stop the vehicle unless absolutely necessary.

Dynamic Brake Lights (if equipped)

If you are driving over 50 km/h and brake forcefully (or if Automatic Emergency Braking engages), the brake lights flash quickly to warn other drivers that Model Y is rapidly slowing down. If Model Y stops completely, the hazard warning lights flash. Flashing continues until you press the accelerator or manually press the hazard lights button to turn them off (see [Hazard Warning Flashers on page 83](#)).

NOTE: Dynamic brake lights will not flash while Track Mode is enabled (see [Track Mode on page 94](#)).

NOTE: When towing a trailer (if applicable), the brake lights on the trailer also operate as described above, even when the trailer is not equipped with a separate braking system.

WARNING: When towing a trailer (if applicable), always increase your following distance. Sudden braking may result in skidding, jack-knifing, and loss of control.

Brake Disc Wiping

To ensure brakes remain responsive in cold and wet weather, Model Y is equipped with brake disc wiping. When cold and wet weather is detected, this feature repeatedly applies an imperceptible amount of brake force to remove water from the surface of the brake discs.

Hydraulic Fade Compensation

Model Y is equipped with hydraulic fade compensation. This assists in monitoring brake system pressure and ABS activity for instances of reduced brake performance. If reduced brake performance is detected (for example, as a result of brake fade, or cold or wet conditions), you may hear a sound, feel



Braking and Stopping

the brake pedal pull away from your foot, and notice a strong increase in braking. Brake as you normally would and continue to press the brake pedal without releasing or pumping the brakes.

CAUTION: In emergency situations, if the brakes are not functioning properly, press and hold the Park button on the drive stalk to bring Model Y to a stop. Do not use this method to stop the vehicle unless absolutely necessary.

WARNING: Always maintain a safe driving distance from the vehicle in front of you and exercise caution when driving conditions are hazardous. Brake disc wiping and hydraulic fade compensation is not a substitute for adequately applying the brakes.

Hydraulic Boost Compensation

Model Y is equipped with a brake booster that activates the brakes when the brake pedal is pressed. Hydraulic boost compensation provides mechanical assistance if the brake booster fails. If a brake booster failure is detected, the brake pedal feels stiffer to press and you may hear a sound when you press the brake pedal. To stop Model Y, apply steady force to the brake pedal without releasing or pumping. Drive cautiously and maintain a safe distance from other road users—brake pedal responsiveness and braking performance may be degraded.

Regenerative Braking

Whenever Model Y is moving and your foot is off the accelerator, regenerative braking slows down the vehicle and feeds any surplus power back to the Battery. By anticipating your stops and reducing or removing pressure from the accelerator pedal to slow down, you can take advantage of regenerative braking to increase driving range.

Vehicle deceleration due to regenerative braking may vary depending on the current state of the Battery. For example, regenerative braking may be limited if the Battery is cold or is already fully charged.

The power meter (a thin line in the touchscreen's car status area) displays real-time power usage:

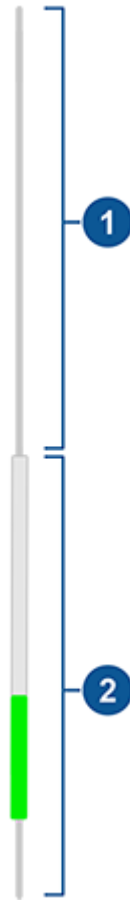

1. Represents power being output by the Battery, such as that used to accelerate the vehicle. When you press the accelerator pedal, the top half of the power meter fills with black (or white if the display is dark).
2. Represents power generated from regenerative braking, or power that is captured from slowing down the vehicle. Power being fed back to the Battery displays in green whereas power used by the regular braking system displays in gray.

NOTE: Installing winter tires with aggressive compound and tread design may result in temporarily-reduced regenerative braking power. However, your vehicle is designed to continuously recalibrate itself, and after changing tires it will increasingly restore regenerative braking power after some straight-line accelerations. For most drivers this occurs after a short period of normal driving, but drivers who normally accelerate lightly may need to use slightly harder accelerations while the recalibration is in progress. Touch **Service > Wheel & Tire > Tires** to select winter tires and quicken this process.

NOTE: If regenerative braking is aggressively slowing Model Y (such as when your foot is completely off the accelerator pedal at highway speeds), the brake lights turn on to alert others that you are slowing down.



NOTE: Because Model Y uses regenerative braking, the brake pads are typically used less frequently than those in traditional braking systems. To avoid the accumulation of rust and corrosion, Tesla recommends frequently pressing the brake pedal to apply the mechanical brakes and dry the brake pads and rotors.

 **WARNING:** In snowy or icy conditions, Model Y may experience loss of traction during regenerative braking, particularly when in the **Standard** setting and/or not using winter tires. Tesla recommends using the **Low** setting in snowy or icy conditions to help maintain vehicle stability.

To Set the Regenerative Braking Level

NOTE: The regenerative braking setting is unavailable for vehicles manufactured as of approximately January 2024.

You can use the touchscreen to change the level of regenerative braking:

1. Touch **Controls > Dynamics > Regenerative Braking**.
2. Choose from two levels:
 - **Low:** Limits regenerative braking. When you release the accelerator, Model Y takes longer to slow down and coasts farther than if set to "Standard".
 - **Standard:** Provides the maximum amount of regenerative braking. When you release the accelerator, Model Y slows down, reducing the need to use the brakes.

Stopping Mode

NOTE: Stopping Modes are unavailable for vehicles manufactured as of approximately January 2024.

Regenerative braking decelerates Model Y whenever you release the accelerator pedal when driving. You can choose what you want Model Y to do once the driving speed has been reduced to a very low speed (almost at a stop) and both the accelerator pedal and brake pedal are released. While in Park, touch **Controls > Dynamics > Stopping Mode** and choose from these options:

- **Creep:** When close to, or at, a complete stop, the motor continues to apply torque, moving Model Y slowly forward (in Drive) or backwards (in Reverse), similar to a conventional vehicle with an automatic transmission. In some situations, such as on a steep hill or driveway, you may need to press the accelerator pedal to continue moving or to prevent Model Y from moving in the opposite direction.

 **WARNING:** Never rely on **Creep** to apply enough torque to prevent your vehicle from rolling down a hill. Always press the brake pedal to remain stopped or the accelerator pedal to proceed up the hill. Failure to do so can result in property damage and/or a collision.

- **Hold:** Maximizes range and reduces brake wear by continuing to provide regenerative braking at speeds lower than with the Creep and Roll settings. When Model Y stops, the brakes are automatically applied without you having to put your foot on the brake pedal. Whether stopped on a flat surface or a hill, Vehicle Hold keeps the brake applied, provided your foot remains off the accelerator and brake pedals. See [Vehicle Hold on page 91](#).

 **WARNING:** Never rely on **Hold** to adequately decelerate or fully stop your vehicle. Many factors can contribute to a longer stopping distance, including downward slopes, and reduced or limited regenerative braking (see [Regenerative Braking on page 86](#)). Always be prepared to use the brake pedal to adequately decelerate or stop.

- **Roll:** When close to, or at, a complete stop, Model Y becomes free rolling like a vehicle in Neutral. Therefore, if stopped on a slope, Model Y will roll downward. The brake does not engage, and the motor does not apply torque (until the accelerator pedal is pressed).

NOTE: If you choose **Creep** or **Roll**, you can still use Vehicle Hold to apply the brakes. However, you will need to briefly press the brake pedal when the vehicle is stopped. See [Vehicle Hold on page 91](#).

NOTE: When Model Y is in Track Mode (see [Track Mode on page 94](#)), **Roll** is automatically enabled, regardless of your chosen setting. When no longer in Track Mode, Model Y reverts to your chosen setting.

NOTE: Your preferred Stopping Mode setting does not sync to your driver profile.

 **WARNING:** Press the brake pedal if Model Y moves when unsafe to do so. It is your responsibility to stay alert and be in control of the vehicle at all times. Failure to do so can result in serious damage, injury, or death.

 **WARNING:** Do not rely on regenerative braking and your chosen Stopping Mode to keep you and your vehicle safe. Various factors such as driving with a heavy vehicle load, on a steep hill, or on wet or icy roads affect deceleration rate and the distance at which Model Y will come to a stop. Drive attentively and always stay prepared to use the brake pedal to stop as appropriate based on traffic and road conditions.

 **WARNING:** Forward Collision Warning and Automatic Emergency Braking do not operate when driving at very low speeds (see [Collision Avoidance Assist on page 137](#)). Do not rely on these features to warn you, or to prevent or reduce the impact of a collision.

Parking Brake

To engage the parking brake, touch **Controls > Safety**, press the brake pedal and then touch **Park Brake**.



Braking and Stopping



A red parking brake indicator lights up on the touchscreen when the parking brake is engaged.

The parking brake is released when the vehicle is shifted into another gear.

You can also engage the parking brake by pressing and holding the button on the end of the drive stalk while in Park.



If the parking brake experiences an electrical issue, the amber parking brake indicator lights up and a fault message displays on the touchscreen.

NOTE: The parking brake operates on the rear wheels only, and is independent of the pedal-operated brake system.



CAUTION: In the unlikely event that Model Y loses electrical power, you cannot access the touchscreen and are therefore unable to release the parking brake without first jump starting (see [Jump Starting on page 223](#)).



WARNING: In snowy or icy conditions the rear wheels may not have sufficient traction to prevent Model Y from sliding down a slope, particularly if not using winter tires. Avoid parking on hills in snowy or icy conditions. You are always responsible for parking safely.



WARNING: Your Model Y may display an alert if the road is too steep to safely park on, or if the parking brakes are not properly engaged. These alerts are for guidance purposes only and are not a substitute for the driver's judgment of safe parking conditions, including specific road or weather conditions. Do not depend on these alerts to determine whether or not it is safe to park at any location. You are always responsible for parking safely.

Brakes must be periodically inspected visually by removing the tire and wheel. For detailed specifications and service limits for rotors and brake pads, see [Subsystems on page 212](#). Additionally, Tesla recommends cleaning and lubricating the brake calipers every year or 20,000 km if in an area where roads are salted during winter months.





WARNING: Neglecting to replace worn brake pads damages the braking system and can result in a braking hazard.

Brake Wear

Model Y brake pads are equipped with wear indicators. A wear indicator is a thin metal strip attached to the brake pad that squeals as it rubs against the rotor when the pad wears down. This squealing sound indicates that the brake pads have reached the end of their service life and require replacement. To replace the brake pads, contact Tesla Service.

This feature may be temporarily limited or inactive until it is enabled with a future software update for vehicles manufactured as of approximately mid-February 2024.

Model Y is designed to detect the presence of objects. When driving slowly (for example, when parking), the vehicle alerts you if an object is detected in close proximity of your Model Y. The vehicle alerts you when objects are detected in front of Model Y when you are in Drive, and behind Model Y when you are in Reverse.

-  **WARNING:** You may not be alerted if Model Y rolls freely in the opposite direction (for example, Park Assist does not display an alert if Model Y rolls backwards down a hill while in Drive).
-  **WARNING:** Never depend on Park Assist to inform you if an area you are approaching is free of objects and/or people. Several external factors can reduce the performance of Park Assist, causing either no readings or false readings (see [Limitations and False Warnings on page 90](#)). Therefore, depending on Park Assist to determine if Model Y is approaching an obstruction can result in damage to the vehicle and/or objects, and can potentially cause serious injury. Always inspect the area with your own eyes. When reversing, perform shoulder checks and use all mirrors. Park assist does not detect children, pedestrians, bicyclists, animals, or objects that are moving, protruding, located too far above or below the cameras, or too close or too far from the cameras. Park Assist is for guidance purposes only and is not intended to replace your own direct visual checks. It is not a substitute for careful driving.

Tesla Vision Park Assist

NOTE: Depending on market region, vehicle configuration, options purchased, and software version, your vehicle may not be equipped with Tesla Vision Park Assist.

Your vehicle uses the cameras mounted on the front, rear, and sides of Model Y to create a high-fidelity reproduction of surrounding objects on the touchscreen.

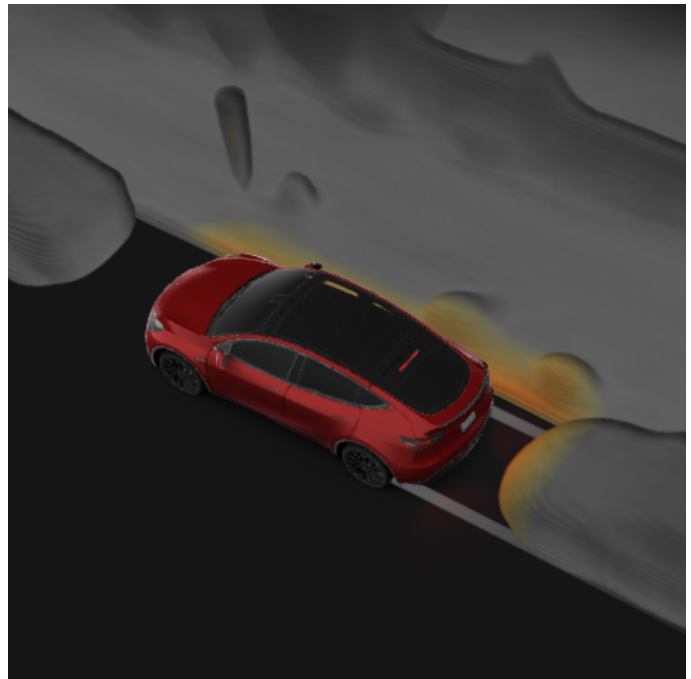

The colors on the visualization correspond to the distance between Model Y and the object shown. Red is closer to Model Y, and yellow is farther from Model Y.



Visual and Audio Feedback

When you shift to Reverse, the Park Assist view displays on the touchscreen, showing objects that are in close proximity to the front and rear of Model Y. This view closes when you shift into Drive unless an object is detected close to the front of Model Y, in which case the Park Assist view closes automatically when you start driving faster than the speed at which Park Assist operates. When reversing, visual feedback also displays on the touchscreen (see [Rear Facing Camera\(s\) on page 99](#)). You can manually close the park assist view on the touchscreen by touching the **X**.

When driving at low speeds with the Camera app displayed on the touchscreen, you can switch to the Park Assist view by touching the button located in the upper left corner of the Camera app screen. This is useful if you need assistance with parallel parking.

If chimes are turned on (see [Controlling Audible Feedback on page 90](#)), an audible beep sounds as you approach an object.

NOTE: If Park Assist is unable to provide feedback, the touchscreen displays an alert message.

-  **CAUTION:** Keep cameras clean from dirt, debris, snow, and ice. Avoid using a high pressure power washer on the cameras, and do not clean a camera with a sharp or abrasive object that can scratch or damage its surface.
-  **CAUTION:** Do not install accessories or stickers on or near the cameras.

Controlling Audible Feedback

You can use Park Assist with or without audible feedback. To turn chimes on or off, touch **Controls > Safety > Park Assist Chimes**.

Limitations and False Warnings

Park Assist may not function correctly in these situations:

- One or more of the sensors (if equipped) or cameras is damaged, dirty, or obstructed (such as by mud, ice, or snow, or by a vehicle bra, excessive paint, or adhesive products such as wraps, stickers, rubber coating, etc.).
- The object is located below approximately 20 cm (such as a curb or low barrier).



CAUTION: Shorter objects that are detected (such as curbs or low barriers) can move into a blind spot. Model Y cannot alert you about an object while it is in a blind spot.

- Weather conditions (heavy rain, snow, or fog).
- The object is thin (such as a sign post).
- Park Assist's operating range has been exceeded.
- The object is sound-absorbing or soft (such as powder snow).
- The object is sloped (such as a sloped embankment).
- Model Y has been parked in, or being driven in, extremely hot or cold temperatures.
- The object is located too close to the bumper.
- A bumper is misaligned or damaged.
- An object that is mounted to Model Y is interfering with and/or obstructing Park Assist (such as a bike rack or bumper sticker).
- Model Y rolls freely in the opposite direction you selected (for example, Park Assist does not display an alert if Model Y rolls backwards down a hill while in Drive).

Other Parking Aids

In addition to Park Assist, when shifted into Reverse, the backup camera displays a view of the area behind Model Y (see [Rear Facing Camera\(s\) on page 99](#)).

When Model Y is stopped, Vehicle Hold can continue to apply the brakes even after you remove your foot from the brake pedal.

Vehicle Hold will activate:

- **Hold:** Vehicle Hold is automatically enabled any time the vehicle comes to a complete stop.
- **Creep or Roll:** Vehicle Hold is enabled automatically anytime the vehicle is at a standstill and the brake is pressed to the floor.



This indicator displays on the touchscreen whenever Vehicle Hold is actively braking Model Y.

To disengage Vehicle Hold, press the accelerator pedal or press and release the brake pedal.

NOTE: Shifting into Neutral also disengages Vehicle Hold.

NOTE: After actively braking Model Y for approximately ten minutes, Model Y shifts into Park and Vehicle Hold cancels. Model Y also shifts into Park if it detects that the driver has left the vehicle.



Traction Control

What It Is

The traction control system constantly monitors the speed of the front and rear wheels. If Model Y experiences a loss of traction, the system minimizes wheel spin by controlling brake pressure and motor power. By default, the traction control system is on. Under normal conditions, it should remain on to ensure maximum safety.



This yellow indicator flashes on the touchscreen whenever the traction control system is actively controlling brake pressure and motor power to minimize wheel spin. If the indicator stays on, a fault is detected with the traction control system. Contact Tesla Service.



WARNING: Traction control cannot prevent collisions caused by driving dangerously or turning too sharply at high speeds.

How It Works

Touch **Controls** > **Dynamics** to access traction control settings.

- **Slip Start** is designed to make it easier to dislodge Model Y when stuck in mud, snow, ice, etc. Turning on Slip Start allows the wheels to spin, making it possible to rock Model Y out of a situation in which the wheels are stuck.
- **Off-Road Assist (All-Wheel Drive vehicles only)** is designed to provide overall improvements when driving off-road. In addition to allowing the wheels to spin, Off-Road Assist balances the torque between the front and rear motors to optimize traction. Off-Road Assist improves traction on rough and soft surfaces where one side of the vehicle may lose traction while the other side still has traction. When Off-Road Assist is on, the accelerator pedal provides more gradual torque, which is useful for crawling at low speeds (for example, over rocky surfaces). When enabled, **Off-Road** displays on the touchscreen above the driving speed.

NOTE: **Off-Road Assist** cannot be used if Speed Limit Mode is already enabled.

After the circumstances that required you to turn on **Slip Start** or **Off-Road Assist** have passed, it is strongly recommended that you turn the setting off to re-enable traction control. If you leave these settings on, traction control automatically re-enables on your next drive.



When you turn on Slip Start or Off-Road Assist, the touchscreen displays an indicator light to indicate that the traction control system is no longer preventing wheel slip.

NOTE: Although you can use **Slip Start** or **Off-Road Assist** at any speed, it is less effective at higher speeds.

NOTE: **Slip Start** or **Off-Road Assist** are not available when you are actively using Autopilot.

NOTE: Engaging cruise control when **Slip Start** or **Off-Road Assist** is on causes the feature to turn off and traction control to be re-enabled.

NOTE: **Automatic Emergency Braking** and **Lane Departure Avoidance** do not operate when **Off-Road Assist** is turned on.



Touch **Controls > Dynamics > Acceleration** to adjust the amount of acceleration you experience when driving Model Y:

- **Chill:** Limits acceleration for a smooth and gentle ride.
NOTE: When **Chill** is selected, **Chill** displays on the touchscreen above the driving speed.
- **Standard:** (*Non-Performance vehicles*) Provides the normal level of acceleration.
NOTE: If equipped with the Acceleration Upgrade package, the modes of acceleration are **Chill** and **Sport**.
- **Sport:** (*Performance vehicles/Acceleration Upgrade package*) Provides the maximum level of acceleration immediately available.

You can improve the efficiency of the cabin heating by reducing your selected acceleration mode. This allows the heat pump system to take more heat from the Battery to efficiently heat the cabin, instead of maintaining the Battery's ability to provide peak acceleration performance. This helps to maximize driving efficiency in colder weather. Note that when subsequently increasing the acceleration mode, the Battery requires time to warm up before the increased level of acceleration is available.



Track Mode

Track Mode, available only on Performance Model Y vehicles, is designed to modify the stability control, traction control, regenerative braking, and cooling systems to increase performance and handling while driving on closed circuit courses. Track Mode improves cornering ability by intelligently using the motors, and regenerative and traditional braking systems. When enabled, the cooling system runs at an increased level before, during, and after aggressive driving sessions to allow your vehicle's systems to withstand the surplus heat.

NOTE: Track Mode is designed and calibrated for a Performance Model Y equipped with performance brakes and tires. Vehicles without performance brakes and tires may experience comparatively lower performance and endurance.

WARNING: Track Mode is designed for use on closed circuit driving courses only. It is the driver's responsibility to drive safely and ensure others are not endangered.

WARNING: Track Mode is designed for use by experienced track drivers familiar with the course. Do not use on public roads. It is the driver's responsibility to be in control of the vehicle at all times, including on the track. Because vehicle behavior (including traction and stability control) differs when using Track Mode, always use caution.

Using Track Mode

Track Mode is always disabled when you start Model Y. To enable Track Mode for your current drive, shift into Park and follow these steps:

1. Touch **Controls > Dynamics > Track Mode**.

When enabled, **TRACK** displays on the touchscreen above the driving speed, and a Track Mode pop up window appears on the map. The car status area of the touchscreen displays a color-coded image of your Model Y that provides you with important at-a-glance status information about the Battery, the motors, the tires and the brakes. See [Monitoring Vehicle Health on page 95](#).

2. If desired, customize the Track Mode settings by touching **Track Mode Settings** on the Track Mode pop up window (see [Customizing Track Mode on page 94](#)). You can also access the Track Mode settings by touching **Controls > Dynamics**, then touching **Customize** next to the Track Mode setting.

NOTE: For optimum performance, wait for the battery and motor temperatures to reduce if highlighted in yellow or red.

3. If you want to use the Lap Timer, follow the onscreen instructions to drop a pin on the map to define the lap's start/finish location. You will then need to press **START** on the Lap Timer to begin your driving session. Once started, the Lap Timer starts counting when you drive Model Y past the lap's start/finish location where you dropped the pin. See [Using the Lap Timer on page 95](#).
4. Shift and **GO!**

If you started the Lap Timer, each time you pass the start/finish location, the timer resets for the next lap. See [Using the Lap Timer on page 95](#).

You can also view a real-time accelerometer (G-meter) by swiping the Cards area of the touchscreen. See [G-Meter on page 95](#).

When Track Mode is on:

- Autopilot features are unavailable.
- The Slip Start setting is overridden.
- Stopping Mode is set to the Roll setting in which Model Y is free-rolling at very low speeds whenever Drive or Reverse is engaged and both the accelerator and brake pedal are released. For details, see [Stopping Mode on page 87](#).
- Energy usage increases.
- Entertainment features are unavailable.

Use the touchscreen setting to turn Track Mode off at any time. Powering off Model Y also turns off Track Mode (although it may still appear on the touchscreen if Post-Drive cooling is in progress). When Track Mode is off, all settings return to their previous state and all features return to their normal operating state.



CAUTION: Driver assistance features are automatically disabled when Track Mode is On. It is the driver's responsibility to drive safely and be in control of the vehicle at all times. Driver assistance features automatically re-enable when Track Mode is turned Off.

Customizing Track Mode

To customize Track Mode, touch **Track Mode Settings** on the Track Mode popup window that appears on the map when you enable Track Mode. You can also access the Track Mode settings by touching **Controls > Dynamics**, then touching **Customize** next to the Track Mode setting. Choose an existing Track Mode setting from the list of pre-defined profiles provided by Tesla. Or create a new settings profile by touching **Add New Settings**, entering a name for the settings profile, then adjusting these settings to suit your preferences or driving scenario, or customize for a specific track:

- **Handling Balance** - Drag the slider to customize the balance of Model Y in a turn. If Model Y is too loose, you can choose a front-biased under-steering setup. Difficult to get the vehicle through a turn? Try a rear-biased setup to increase rotation. You can select any value, in 5% increments, between 100/0 (for 100% front biased used for under-steering) and 0/100 (for 100% rear biased used for over-steering).
- **Stability Assist** - Drag the slider to choose the level at which the stability control systems assist in controlling the vehicle. You can choose any level from -10 to +10. Choosing +10 engages all stability assist systems for controllable driving in which stability systems remain

engaged, whereas -10 disables all stability systems and the stability of the drive rests solely on the driver. The default setting of 0 represents a balance which provides some stability being automatically controlled and leaving some control up to the driver.

- **Regenerative Braking** - Drag the slider to choose how much regenerative braking is available. You can choose any value, in 5% increments, between 0 and 100%. Tesla recommends the 100% setting to prevent overheating the brakes.
- **Post-Drive Cooling** - Enable if you want the cooling systems to continue cooling the vehicle's components even after you leave the vehicle. Cooling stops automatically when the components are sufficiently cool, or when you power Model Y off and back on again. Post-Drive Cooling is useful if you want to quickly cool the components between driving sessions. If Post-Drive Cooling is set to OFF, the components eventually cool, but it takes longer.
- **Save Dashcam for Laps** - Enable if you want to save a video and data on a USB flash drive when using the Lap Timer. A USB flash drive must be set up and inserted as described (see [USB Drive Requirements for Recording Videos on page 148](#)). The USB flash drive must contain a folder named **TeslaTrackMode**. When enabled, Track Mode stores a video and associated data for each lap. Track Mode also stores the car status and telemetry data with details about the vehicle's position, speed, acceleration, use of accelerator, etc. You can then view the video recordings and analyze this data, which is saved as a .CSV file on the USB flash drive, to determine where time is being lost or gained.

NOTE: For some vehicles manufactured after approximately November 1, 2021, the center console USB ports may only support charging devices. Use the USB port inside the glove box for all other functions.

Track Mode allows you to save up to 20 settings profiles. To delete a chosen profile, touch **Delete** at the bottom of the settings screen.

NOTE: You can not change or delete a pre-defined profile provided by Tesla.

Using the Lap Timer

When you enable Track Mode, the map displays a Lap Timer. Follow the onscreen instructions to place a start/finish pin on the map. Once the pins are placed, press **START** to initiate the driving (lapping) session. When you drive Model Y through the start/finish location, the Lap Timer automatically starts timing the duration of the lap, resetting the timer whenever you pass the start/finish location, and displaying the real-time delta between the current lap and the fastest lap so far in the driving session. The map highlights the track in blue.

At the completion of each lap, the Lap Timer displays the duration of the lap. It also displays the times associated with the previous and best laps in the driving session.

If **Save Dashcam for Laps** is on (see [Customizing Track Mode on page 94](#)), and a properly formatted USB flash drive is inserted in a front USB port, Track Mode saves a video of the driving session (as recorded by the front cameras), along with a .CSV file that provides detailed information about the lap.

NOTE: To stop the timer at the end of your driving session, touch **STOP** on the Lap Timer popup window.

Monitoring Vehicle Health

You can easily monitor the health of Model Y when using Track Mode by glancing at the car status area of the touchscreen. The colors indicate the status of the various components, allowing you to determine the current operating state and make decisions accordingly. The components are displayed in green when operating within their ideal temperature range. Colors change as follows:

- The Battery displays blue when cold and red when hot.
- A brake displays blue when cold and red when hot (an early warning for overheating brakes).
- A motor displays blue when it's cold or red when it's hot.
- Dynamic readings of the tire pressures displays on the touchscreen. A tire displays blue when under-used or red when the peak grip is exceeded.

NOTE: A component displayed in red may indicate a need to stop driving and allow the component to cool.



CAUTION: Any vehicle damage or injuries caused by using Track Mode is the driver's responsibility. The vehicle warranty does not cover damage caused by excessive overuse of vehicle components. It also does not cover racing, autocross, or driving in competition.

G-Meter

In Track Mode, a real-time G-Meter displays on the touchscreen. The G-Meter graphically displays peak lateral, acceleration, and deceleration values in the form of a circular meter. The history of your drive is represented in the shaded area. The G-Meter resets at the start of each driving session.

NOTE: You can swipe the G-Meter card to display a different card. However, the G-Meter displays as the default card whenever you engage Track Mode.



Driver Profiles

When you first adjust the driver's seat, steering wheel position, or exterior side mirrors, the touchscreen prompts you to create a driver profile to save these adjustments. Your profile also saves various preferences you make while customizing Model Y.

To save your profile settings to the cloud and access them across multiple Tesla vehicles, set up a Tesla Profile (see [Using Tesla Profiles on page 96](#)).



To add a new driver profile, touch the driver profile icon at the top of the touchscreen. Then touch **Driver Profile Settings > Add New Driver**, type the driver's name and touch **Create Profile**. Follow the onscreen instructions to save mirror and steering wheel position to the driver profile.

Check the **Use Easy Entry** checkbox if you want to save (or use existing) **Easy Entry** settings in which the driver's seat and the steering wheel are automatically adjusted to make it easy to enter and exit Model Y.

If you change the position of the driver's seat, steering wheel, or exterior side mirrors after you have saved or chosen a driver profile, the touchscreen prompts you to **Save** the new position or **Restore** the previously saved position (other settings are automatically saved). To change a setting without saving or restoring, just ignore the prompt.

To delete a driver profile, touch the driver profile icon at the top of the touchscreen, touch **Driver Profile Settings** and select the driver profile you want to remove. Once selected, **Delete** the driver profile.

NOTE: Valet mode is a built-in driver profile that limits speed and restricts access to some Model Y features (see [Valet Mode on page 97](#)).

NOTE: To stop automatic adjustments that are in process based on a driver's profile, touch **Stop** on the Driver Profile dropdown menu. Automatic adjustments also stop if you manually adjust a seat, mirror, or the steering wheel.

Selecting Between Driver Profiles



To adjust Model Y based on a driver's profile, touch the driver profile icon at the top of the **Controls** screen. Then choose the driver, and Model Y is adjusted based on the settings that have been saved to the chosen driver profile. See [Using Tesla Profiles on page 96](#) to learn more about saving profile settings to the cloud for easy access across multiple Tesla vehicles.

NOTE: Your preferred Stopping Mode setting does not sync to your driver profile. For more information, see [Braking and Stopping on page 85](#).

Using Tesla Profiles

(If equipped) Driver profile settings, such as seat adjustments, temperature preferences, navigation Recents and Favorites, media settings, and data sharing preferences can be saved into a Tesla Profile that is synced to every supported vehicle under your Tesla Account. This provides convenient access to your profile settings and preferences across all your Tesla supported vehicles.

To set up your Tesla Profile, navigate to **Driver Profile Settings** and select your Tesla Account name. You can choose to set it up as a New Profile or copy the settings from an existing driver profile that you were previously using.

To set up a Tesla Profile for additional drivers, share your vehicle with them from the mobile app and navigate to **Security & Drivers > Manage Drivers > Add Driver**. Their Tesla Profile will appear in the Driver Profile settings after accepting the invitation from their Tesla Account. If you remove their access to the vehicle, it also removes their Tesla Profile. For more information on granting mobile app access, see [Granting Access to a Second Driver on page 65](#). In addition, you can change your profile picture from your Tesla Mobile App.

NOTE: Some vehicle settings are synced only between similar vehicle models. If the seat, steering, and mirror positions do not restore as expected, touch **Controls > Service > Driver Seat, Steering, & Mirrors Calibration** on the affected vehicles. If the setting for **Autopilot Activation** does not restore as expected, touch **Controls > Autopilot > Autopilot Activation** (see [Autopilot Settings on page 108](#)).

NOTE: Tesla Profiles are supported on vehicles with software versions 2022.24 or higher.

To remove your Tesla Profile from a vehicle, remove that vehicle from your Tesla account:

1. In the Tesla mobile app, touch the profile icon in the top-right corner.
2. Touch **Add/Remove Products**.
3. Touch **Remove**.
4. Select the vehicle you'd like to remove.

Saved Settings

A subset of the settings that you choose to customize your Model Y are automatically saved to your driver's profile. Once saved, a green check mark appears next to the driver profile icon on the touchscreen. Examples of automatically saved driver profile settings are:

- Navigation, temperature, lights and display settings.
- Autopilot and driving preferences.



Linking a Driver Profile to a Key

You can link a driver profile to a key (or keys) to allow Model Y to automatically select the correct driver profile when the linked key is detected as you approach the vehicle and open the driver's door. To link a driver profile to a key, first ensure you are using your desired driver profile, then touch **Controls** > **Locks** > **Keys**. You can toggle the driver icon to link or delete a key to the desired driver profile. The name of the driver profile appears under the key to show that it is linked.

NOTE: Model Y supports up to 10 driver profiles. You can link multiple keys to a driver profile, but you cannot link multiple driver profiles to a single key.

Easy Entry

You can define an Easy Entry setting that moves the steering wheel and driver's seat to make it easy to enter and exit Model Y. Any driver can use the Easy Entry setting by associating it with their driver profile. When the Easy Entry setting is associated with a driver profile, the steering wheel and driver's seat automatically adjust when in Park and the driver's seat belt is unbuckled, allowing an easy exit from (and next entrance into) Model Y. When returning to the vehicle and stepping on the brake pedal, settings automatically adjust back to the settings used by the most recent driver profile (or based on the key if it's linked to a driver profile).

To use **Easy Entry** with a driver profile, ensure the **Use Easy Entry** box is checked.

⚠ WARNING: Never use Easy Entry to move the driver's seat to the full rearward position when a child safety seat is installed on a rear seat located behind the driver's seat. With reduced clearance, the movement of the seat may impact a child's legs, cause injury, or dislodge the seat.

Valet Mode

When Model Y is in Valet mode, the following restrictions apply:

- Key card must be used to access and drive Model Y.
- Speed is limited to 113 km/h.
- Maximum acceleration and power are limited.
- Front trunk and glovebox are locked.
- Home and Work locations are not available in the navigation system.
- Voice commands are disabled.
- Autopilot convenience features are disabled.
- The Allow Mobile Access setting cannot be changed.
- HomeLink (if available in your market region) is not accessible.
- Driver Profiles are not accessible.

- Some apps, such as Toybox and Theater, are not accessible.
- The touchscreen does not display the list of keys that can access Model Y (see [Managing Keys on page 20](#)).
- Wi-Fi and Bluetooth are disabled. When Model Y is in Valet mode, you cannot pair new Bluetooth devices or view or delete existing paired devices. However, if a Bluetooth-paired device or a known Wi-Fi network is within range, Model Y connects to it.

Starting Valet Mode

With Model Y in Park, touch the driver profile icon at the top of the **Controls** screen, then touch **Valet Mode**.

The first time you enter Valet mode, the touchscreen prompts you to create a 4-digit PIN you will use to cancel Valet mode.

When Valet mode is active, the touchscreen displays the word **Valet** while the driver profile changes to **Valet Mode** on the touchscreen.

You can also use the mobile app to start and cancel Valet mode (if Model Y is in Park). When using the mobile app, you do not need to enter a PIN because you are already required to log into the app using your Tesla Account credentials.

NOTE: If **PIN to Drive** is enabled (see [PIN to Drive on page 143](#)), you must enter the driving PIN before you can define or enter a Valet PIN. Once in Valet mode, Model Y can be driven without the valet needing to enter the driving PIN.

NOTE: The **PIN to Drive** setting is not available when Valet mode is active.

If you forget your valet PIN, reset it from inside Model Y by entering your Tesla Account credentials (which also cancels Valet mode). You can also reset your PIN using the mobile app.

Canceling Valet Mode

With Model Y in Park, touch the **Valet Mode** driver profile icon at the top of the **Controls** screen, and enter your 4-digit PIN.

When you cancel Valet mode, all settings associated with the most recently used driver profile and climate control settings are restored, and all features are available.

NOTE: You do not need to enter a PIN to cancel Valet mode from the mobile app.



Displaying Trip Information

Trip information displays on the touchscreen in the cards area on the car status display, or when you touch **Controls** > **Trips**. For the current trip, you can display distance, duration and average energy usage. You can also show distance and total and average energy used since your last charge and for additional trips.

To name or rename a trip, touch the trip's name, enter a new name for the trip, then press **Save**. To reset a particular trip meter, touch its associated **Reset** button.

Odometer

To display the odometer and view vehicle mileage, do either of the following:

- Touch **Controls** > **Software**.
- Touch **Controls** > **Trips**.
- Open the mobile app and scroll down to the bottom of the main screen.



Camera Location

Model Y is equipped with a rear view camera located above the rear license plate.



WARNING: Never depend on the cameras to inform you if the area behind you is free of objects and/or people. The cameras may not detect objects or barriers that can potentially cause damage or injury. In addition, several external factors can reduce the performance of the cameras, including a dirty or obstructed lens. Therefore, depending on the cameras to determine if Model Y is approaching an obstruction can result in damage to the vehicle and/or objects and can potentially cause serious injury. Always inspect the area with your own eyes. When reversing, perform shoulder checks and use all mirrors. Use the cameras for guidance purposes only. It is not intended to replace your own direct visual checks and is not a substitute for careful driving.

To ensure a clear picture, the camera lens must be clean and free of obstructions. See [Cleaning](#) on page 192.

Whenever you shift into Reverse, the touchscreen displays the view from the camera. Lines show your driving path based on the position of the steering wheel. These lines adjust as you move the steering wheel.

Model Y also displays images from the side cameras (if equipped). Simply swipe up or down to hide or show the side camera views.

NOTE: Visual feedback from Park Assist also appears on the touchscreen (see [Park Assist](#) on page 89).



To display the view from the rear view cameras at any time, open the app launcher and touch the Camera app.

If a black screen appears on the touchscreen instead of the rear view camera feed when in Reverse, use the rear view mirrors and ensure your surroundings are safe before continuing to Reverse. If inoperability of the rear view camera persists, use the mobile app to schedule a service appointment.



Pedestrian Warning System

(If equipped) The Pedestrian Warning System causes Model Y to emit sound when driving below approximately 33 km/h (21 mph) or while driving in reverse. Electric vehicles operate quietly and this sound helps to alert pedestrians of your oncoming vehicle. The sound, which activates whenever Model Y is shifted out of Park, gets louder as speed increases.

For vehicles manufactured prior to approximately November 2021: In situations where you need to turn the sound off (such as in stop and go highway traffic), touch **Controls > Safety > Pedestrian Warning > Pause**. The sound is paused for the current drive only. On your next drive, the sound automatically turns back on. The switch may not be available for vehicles manufactured after this date.



The touchscreen displays this indicator when the Pedestrian Warning System has been paused and is therefore not active.

NOTE: The Pedestrian Warning System may not be available in vehicles manufactured prior to approximately July 1, 2021.

⚠ WARNING: If sound cannot be heard, pedestrians may not be aware of your oncoming vehicle, which may increase the likelihood of a collision resulting in serious injury or death. Never rely on the Pedestrian Warning System to make sure that pedestrians are aware of your vehicle. If the Pedestrian Warning System is not operating, schedule a service appointment.



The towing package includes a 5 cm x 5 cm hitch receiver that can support an accessory carrier (for bicycles, skis, snowboards, etc.) or tow a trailer.

Installing and Using a Carrier

When using the tow package to carry accessories, the 5 cm x 5 cm square hitch receiver is designed to support vertical loads of up to 72 kg. Ball mounts that are compatible with the square receiver must be purchased separately.

To install and use an accessory carrier, you must first attach the ball mount to the hitch receiver (see [Attaching and Removing the Ball Mount on page 104](#)). Then, follow the instructions provided by your accessory carrier. Observe all regulations and legal requirements in your state or region that apply to carrying accessories.

The Model Y towing package includes the wiring necessary for using an accessory carrier equipped with lights (see [Electrical Connections on page 104](#)). The package also includes Trailer Mode software compatibility (see [Trailer Mode on page 103](#)).

NOTE: Go to <http://www.tesla.com> to purchase accessories for your vehicle. Although third-party products are available, Tesla recommends and supports only Tesla-approved products (see [Parts and Accessories on page 199](#)). The accessory products available for your vehicle may vary based on market region. Before attempting to install a non Tesla-approved carrier, review the product information to ensure compatibility.

NOTE: When not in use, the ball mount should be removed and stored in a dry location to prevent dust and corrosion. Keep the dust cover over the hitch housing to prevent dirt and debris from entering (see [Attaching and Removing the Ball Mount on page 104](#)).

NOTE: Tesla assumes no responsibility for damage or injuries resulting from installing and using an accessory carrier, for any omissions in the instructions accompanying an accessory carrier, or for your failure to follow the instructions. Damage caused by using an accessory carrier is not covered by the warranty.

Carrying Accessories

The hitch receiver is designed to support vertical loads up to 72 kg). When carrying bicycles, skis, or other items on the Model Y hitch, always check to ensure that the maximum weight is not exceeded. When calculating weight, remember to include the weight of the accessory carrier. For example, assuming the carrier weighs 18 kg, the weight threshold is sufficient for carrying two bicycles weighing approximately 27 kg each, or four items weighing approximately 14 kg each.

NOTE: Consult the product details of your accessory carrier for more information, such as additional weight or load limits. Damage caused by non Tesla-approved accessories is not covered by the warranty.

CAUTION: Exceeding the maximum weight the Model Y hitch is designed to support (as previously described) can cause significant damage.

CAUTION: Do not attempt to install an accessory carrier on Model Y that is not equipped with the tow package. Doing so can cause significant damage.

Trailer Towing

The maximum trailer weight (including all cargo and additional equipment), and the trailer tongue weight depend on the number of occupants in your vehicle and the tires being used. The maximum towing capacity and trailer tongue weight must never exceed the following:

Wheel/Rim Size	Passengers	Maximum Towing Capacity	Maximum Tongue Weight
19", 20" and 21"	up to 3	3,500 lbs (1,588 kg)	350 lbs (159 kg)
19" and 21"	4 - 5	3,500 lbs (1,588 kg)	350 lbs (159 kg)
20"	4 - 5	2,300 lbs (1,043 kg)**	230 lbs (104 kg)**

** You must operate within the speed limitations of your trailer and tires, and only drive at speeds appropriate for the load you are towing, the weather, road and traffic conditions, and your level of towing experience. Always obey posted speed limits and local regulations regarding speed.

NOTE: In Canada, towing is limited to 89 km/h.

For trailers with a combined loading of more than 750 kg, Tesla recommends using a separate braking system with an independent controller (see [#unique_330 on page](#)). Carefully follow the instructions provided by the trailer brake manufacturer to ensure that trailer brakes are properly installed, adjusted, and maintained.

The tongue weight is the downward force that the weight of the trailer exerts on the hitch. This must not exceed 10% of the maximum trailer weight. Carrying a significant amount of equipment, passengers, or cargo in the tow vehicle can reduce the towing capacity it can handle, which also reduces the tongue weight. Maximum towing capacity is calculated assuming the is not exceeded (see [Specifications on page 207](#)).

NOTE: If the information on the hitch label conflicts with the information provided in this Owner's Manual, this Owner's Manual takes precedence.

CAUTION: You should only use Model Y to tow if you have experience and knowledge of how towing affects the vehicle and are able to safely load, secure, and maneuver the vehicle and cargo. Tesla's instructions are not all-inclusive of the knowledge and skills necessary for safe towing. Damage caused by towing a trailer is not covered by the warranty.



Towing and Accessories

WARNING: Do not overload the vehicle or trailer. Doing so can cause poor performance, vehicle damage, and loss of vehicle control, resulting in serious injury.

WARNING: Do not use the trailer hitch to transport Model Y (see [Instructions for Transporters on page 217](#)).

Tire Pressures when Towing

When towing a trailer, tire pressures must be adjusted to accommodate the additional load. 19", 20", and 21" tires are acceptable to use for towing. Keep tires inflated to the pressures shown below (if different, these pressures override the pressures that are provided on the Tire and Loading Information Label (see [Vehicle Loading on page 209](#))).

Front Tires	Rear Tires	Cold Tire Inflation Pressure
255/45R19	255/45R19	42 psi (290 kPa)
255/40R20	255/40R20	42 psi (290 kPa)
255/35R21	275/35R21	42 psi (290 kPa)

CAUTION: Do not use Model Y for towing if equipped with tires that are not listed previously.

WARNING: Check tire pressures using an accurate pressure gauge when tires are cold. Driving 1.6 km warms the tires sufficiently to affect tire pressures. Parking the vehicle in direct sunlight or in hot weather can also affect tire pressures. If you must check warm tires, expect increased pressures. Do not let air out of warm tires in an attempt to match recommended cold tire pressures. A hot tire at or below the recommended cold tire inflation pressure may be dangerously under-inflated.

WARNING: Never attempt to tow a trailer when a Model Y tire is faulty or has been temporarily repaired (for example, using a tire repair kit). A temporarily repaired tire is not designed to sustain the towing load. Towing using a faulty or temporarily repaired tire can result in tire failure and loss of vehicle stability.

Before Towing a Trailer

Before towing a trailer, you must do the following:

- Inflate tires to the cold tire inflation pressure specified in [Tire Pressures when Towing on page 102](#).
- Observe all regulations and legal requirements that apply to trailer towing. Failure to comply with regulations can compromise your safety.
- Adjust side mirrors to provide a clear rear view without a significant blind spot.
- Engage **Trailer Mode** (see [Trailer Mode on page 103](#)).

Confirm the following:

- Model Y rests horizontally with the trailer attached. If the vehicle is tipped up at the front and down at the rear, check that you are not exceeding the maximum towing capacity and tongue loads provided in [Trailer Towing on page 101](#).
- Trailer lights (brake lights, turn signal lights, and marker lights) are working properly.
- The trailer tongue is securely connected to the hitch ball.
- Safety chains are properly connected between the trailer and the tow vehicle. Cross the safety chains under the tongue of the trailer to help prevent the tongue from contacting the road if it separates from the hitch. Leave enough slack in the safety chains to allow for turns and ensure that the chains do not drag on the ground.
- All trailer hitch parts and attachments, safety chains, and electrical connectors are in good condition and are properly connected. If any problems are apparent, do not tow the trailer.
- All cargo is secured.
- Wheel chocks are available.
- The trailer load is evenly distributed such that the trailer tongue weight is approximately 4–10% of the total trailer weight, without exceeding the maximum tongue weights provided in [Trailer Towing on page 101](#).

CAUTION: Loads that are balanced over the trailer wheels or heavier in the rear can cause trailer sway, resulting in loss of vehicle control.

WARNING: Always ensure that cargo is secured in the trailer and will not shift. Dynamic load shifts can cause loss of vehicle control, resulting in serious injury.

Towing Guidelines

Model Y is designed primarily as a passenger-carrying vehicle. Towing a trailer puts additional load on the motor(s), drive train, brakes, tires, and suspension and significantly decreases range. If you decide to tow a trailer, proceed with caution and follow these general guidelines:

- Reduce your driving speed and avoid sudden maneuvers. When towing a trailer, steering, stability, turning radius, stopping distance and braking performance are different when compared to driving without a trailer.
- Increase your following distance by maintaining at least twice the distance from the vehicle ahead. This helps to avoid situations that require heavy braking. Sudden braking may result in skidding or jack-knifing, and loss of control.
- Avoid sharp turns. Sharp turns can cause the trailer to contact the vehicle and cause damage. Keep in mind that the trailer wheels are closer to the inside of the turn than the vehicle's wheels. Therefore, make wider turns to prevent the trailer from hitting curbs, road signs, trees or other objects.



- Periodically check the trailer lights and turn signals to confirm that the bulbs are still working. When towing a trailer, the turn signal arrows on the touchscreen flash as normal, even if the bulbs on the trailer are burned out.
- Periodically confirm the cargo is secure.
- Regularly confirm that all towing components are securely tightened.

WARNING: Towing requires you to increase your stopping distance. When towing, increase your following distance and avoid situations that could potentially cause heavy braking. Failure to do so can result in a collision.

WARNING: Observe all regulations and legal requirements in your jurisdiction that apply specifically to trailer towing. Failure to comply with regulations can compromise your safety.

Trailer Mode

Trailer Mode must always be active when towing a trailer. When you connect a trailer's electrical connection while the vehicle is in Park, Model Y automatically engages Trailer Mode. When you disconnect the trailer's electrical connection, Trailer Mode does not automatically disengage. To manually engage or disengage Trailer Mode, touch **Controls > Dynamics > Trailer Mode** on the touchscreen. One of the following indicators displays:

Trailer Mode is active.



Model Y detects a connection for trailer lights but Trailer Mode is disabled. It is likely that a carrying accessory has been connected.



Model Y detects a faulty electrical connection for the trailer lights. Some, or all, trailer lights may not be functioning. Pull over as soon as safety permits and inspect the trailer lights for faulty cabling or connections. If the issues are resolved and the red icon still persists, disable and re-enable Trailer Mode once more.



Some Autopilot features, as well as rear parking sensor functionality, may not be available when Trailer Mode is enabled. In addition, these features operate differently:

- Traffic-Aware Cruise Control increases the following distance from the vehicle in front of you.
- Side collision warnings are active but automatic steering interventions are disabled.

- The braking force provided by Automatic Emergency Braking (see [Collision Avoidance Assist on page 137](#)) may be limited. Therefore, stopping distance may increase.

WARNING: Do not rely on Model Y to detect the trailer and automatically engage Trailer Mode. Always check to ensure Trailer Mode is engaged before towing a trailer.

WARNING: Under no circumstances should you exit Trailer Mode when towing a trailer. Doing so can cause serious injury.

Trailer Brakes

When towing a loaded trailer that weighs more than 750 kg, Tesla recommends that the trailer be equipped with its own brake system adequate for the weight of the trailer. Ensure compliance with local regulations. A brake controller must be purchased separately, and the required 4-pin pigtail connector can be ordered from Tesla Service. Follow these steps to connect the trailer brake controller:

1. Open the passenger side front door and lower the passenger side window.
2. Remove the assembly pillar by removing the clips with a small, flat trim tool.
3. Remove the clip securing the passenger side lower A-pillar trim with a small, flat trim tool.
4. Remove the 6 push clips on the footwell cover.
5. Remove the footwell cover; you will need to disconnect the 2 connector cables on the footwell cover.
6. Remove the lower A-pillar door trim.
7. Remove the passenger carpet.
8. The trailer brake connection should be exposed. Keep all parts in a dry, secure location. Repeat these steps in reverse when you are done with the trailer connection.

Parking with a Trailer

Whenever possible, avoid parking on a grade. However, if parking on a grade is absolutely necessary, place wheel chocks under the trailer wheels. Consider having someone help you with these steps:

1. One person presses and holds the brake pedal.
2. A second person places the wheel chocks under the wheels on the downgrade side of the vehicle's tires.
3. When the chocks are in place, release the brake pedal and ensure the chocks hold the weight of the vehicle and trailer.

NOTE: When testing chocks, ensure that Vehicle Hold (see [Vehicle Hold on page 91](#)) is not engaged. If Vehicle Hold is braking Model Y, the Vehicle Hold indicator light displays on the touchscreen. To disengage Vehicle Hold, press and release the brake pedal.



Towing and Accessories

4. Place the vehicle in Park.

WARNING: If parking on a grade is necessary, always ensure that all trailer wheels have been securely chocked. Failure to do so can result in serious damage or injury.

Trailer Sway Mitigation

When trailer sway is detected, the electronic stability control system attempts to apply the appropriate amount of braking to minimize trailer sway. The touchscreen briefly displays the traction control system indicator. Pressing the brake pedal when the system is actively braking to mitigate trailer sway does not cancel this automatic braking.

Attaching and Removing the Ball Mount

The Model Y towing package does not include a ball mount. You must purchase a ball mount suitable for the type of trailer you are towing. The Model Y hitch receiver supports a ball mount with a length of up to 22 cm and a rise of up to 2 cm. Do not use any type of drop ball mount that does not meet these requirements.

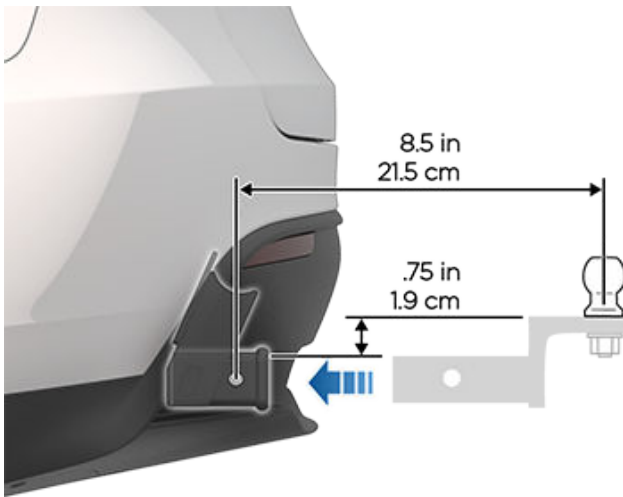

To attach a ball mount:

1. Use a thin object, such as a butter knife or flat blade screwdriver, to pry around the edges of tow hitch cover and release the 15 clips that secure the cover to the rear fascia. Store the dust cover in a secure location.



2. If necessary, remove the cotter pin from the locking bolt and slide the locking bolt out of the hitch assembly.
3. Slide the ball holder into the hitch assembly.
4. Align the hole in the ball holder with the one in the hitch assembly.
5. Slide the locking bolt through the hitch assembly/ball holder.
6. Insert the cotter pin in the hole at the end of the locking bolt.

To remove a ball mount:

1. Remove the cotter pin from the locking bolt and slide the locking bolt out of the ball holder/hitch assembly.
2. Pull the ball holder out of the hitch assembly.
3. Re-install the dust cover for the hitch housing and store the ball mount in a secure location.

Electrical Connections

Regulations require all trailers to be equipped with tail lights, brake lights, side marker lights, and turn signals. To provide power for trailer lighting, a built-in 7-pin wiring connector is provided near the hitch support's wiring plugs for most types of trailers. Plugging in trailer wiring into the Model Y electrical connector automatically engages Trailer Mode (see [Trailer Mode on page 103](#)). It is the driver's responsibility to ensure that all electrical connections are working and all trailer lights are operating before and during towing. You must perform manual checks.

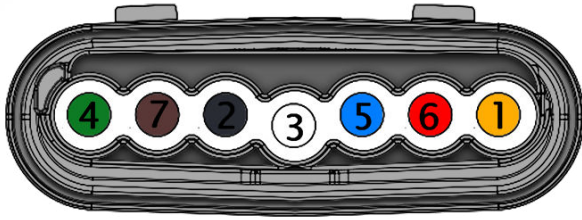

1. Left Turn Signal
2. Reverse Lights
3. Ground
4. Right Turn Signal
5. Brake Controller Output
6. Brake Light
7. Tail Lamps

Loss of trailer lights when towing may be the result of a fault in the trailer wiring or excessive power consumption by the lights connected to the trailer output(s). When this occurs, a red Trailer Mode icon appears on the touchscreen. Fix any issues with the wiring and/or reduce the number of lights connected to the trailer output(s), then toggle Trailer Mode off and on again.

NOTE: Vehicles with a lead-acid low voltage battery have auxiliary power. Vehicles with low voltage lithium-ion batteries do not have auxiliary power at this time. You can determine which battery your vehicle is equipped with by touching **Controls > Software > Additional Vehicle Information**.

CAUTION: Always ensure that the trailer electrical cable does not contact or drag on the ground and there is enough slack in the cable to allow for turns.

WARNING: Use only the electrical connections designed by Tesla. Do not attempt to directly splice or attempt to connect a trailer's electrical wiring using any other method. Doing so can damage the vehicle's electrical system and cause malfunctions.

Impact on Range

Towing a trailer increases vehicle weight and drag. As a result, driving range can decrease significantly. Although Trip Planner (if available in your market region) attempts to adjust estimates based on Trailer Mode, actual energy consumption may vary. Plan trip length and charging destinations accordingly.



About Autopilot

Autopilot is a suite of advanced driver assistance features that are intended to make driving safer and less stressful. None of these features make Model Y fully autonomous or replace you as the driver. Autopilot features come standard with all new Tesla vehicles.

NOTE: Depending on market region, vehicle configuration, options purchased, and software version, your vehicle may not be equipped with the following features, or a feature may not operate exactly as described.

Basic Autopilot includes Traffic-Aware Cruise Control and Autosteer.

- **Traffic-Aware Cruise Control:** Maintains your speed and an adjustable following distance from the vehicle in front of you, if there is one (see [Traffic-Aware Cruise Control on page 108](#)).
- **Autosteer:** Maintains your speed and distance from a leading vehicle while also intelligently keeping Model Y in its lane (see [Autosteer on page 109](#)).

 **WARNING:** Basic Autopilot is a hands-on feature. Keep your hands on the steering wheel at all times and be mindful of road conditions, surrounding traffic, and other road users (such as pedestrians and cyclists). Always be prepared to take immediate action. Failure to follow these instructions could cause damage, serious injury, or death.

Enhanced Autopilot includes additional features. Enhanced Autopilot Features are designed to further reduce driver workload and make common actions, such as changing lanes or parking, easier.

- **Auto Lane Change:** Moves Model Y into an adjacent lane when you engage the turn signal and Autosteer is active (see [Auto Lane Change on page 110](#)).
- **Navigate on Autopilot:** Actively guides Model Y from a highway's on-ramp to off-ramp, including performing lane changes, navigating interchanges, automatically engaging the turn signal, and taking the correct exit (see [Navigate on Autopilot on page 111](#)).
- **Autopark:** Parks Model Y, either parallel or perpendicularly (see [#unique_342 on page](#)).
- **Summon:** Moves Model Y forward or backward, even while you're outside the vehicle. This is useful for parking in tight parking spots (see [Summon on page 125](#)).
- **Smart Summon:** Moves Model Y out of a parking space and through more complex environments, maneuvering around obstacles and other vehicles, to meet you or go to a predetermined target (see [Smart Summon on page 127](#)).

 **WARNING:** Enhanced Autopilot is a hands-on feature. Keep your hands on the steering wheel at all times and be mindful of road conditions, surrounding traffic, and other road users (such as pedestrians and cyclists). Always be prepared to take immediate action. Failure to follow these instructions could cause damage, serious injury or death.

Full Self-Driving Capability includes:

- **Traffic Light & Stop Sign Control:** Maintains your speed, keeps a following distance, and keeps Model Y in its lane while also slowing down and stopping for traffic lights and stop signs (see [Traffic Light and Stop Sign Control on page 116](#)).

 **WARNING:** Full Self-Driving Capability is a hands-on feature. Keep your hands on the steering wheel at all times and be mindful of road conditions, surrounding traffic, and other road users (such as pedestrians and cyclists). Pay attention to the road at all times and always be prepared to take immediate action. Failure to follow these instructions could cause damage, serious injury or death.

How It Works

Autopilot uses the cameras on Model Y, which monitor the surrounding area and detect other vehicles, pedestrians, road markings, and obstacles such as barriers and curbs. There are cameras mounted on the front, rear, left, and right sides of Model Y (see [Cameras on page 16](#)).

Model Y may also be equipped with a cabin camera, mounted in the rear-view mirror, that monitors driver attentiveness. It is your responsibility to keep your hands on the wheel, pay attention to the road, and be ready to take immediate action at any time.

When Autopilot is engaged, Model Y shows a series of escalating warnings reminding you to keep your hands on the wheel and pay attention to the road. If there is no response, Autopilot disengages and is unavailable for the remainder of the drive.

 **WARNING:** Autopilot is designed for your driving comfort and convenience and is not a collision warning or avoidance system. It is your responsibility to stay alert, drive safely, and be in control of the vehicle at all times. Never depend on Autopilot to adequately slow down Model Y. Always watch the road in front of you and be prepared to take corrective action at all times. Failure to do so can result in serious injury or death.

It is your responsibility to familiarize yourself with the limitations of Autopilot and be ready to take control at all times. For more limitations, cautions, and warnings, see [Limitations and Warnings on page 129](#).

Autopilot Conditions

Ensure all cameras are clean and free of obstructions before each drive and before using Autopilot features (see [Cleaning a Camera on page 192](#)). Dirty cameras and sensors (if equipped), as well as environmental conditions such as rain and faded lane markings, can affect Autopilot performance. If a camera is obstructed or blinded, Model Y displays a message on the touchscreen and Autopilot features may not be available. For more information on specific alerts, see [Troubleshooting Alerts on page 226](#).

Before you can use Autopilot features, and after some Service visits, you must drive a short distance to calibrate cameras. For more information, see [Drive to Calibrate Cameras on page 16](#).

In addition, these features may not work as intended when:

- The road has sharp curves or significant changes in elevation.
- Road signs and signals are unclear, ambiguous, or poorly maintained.
- Visibility is poor (due to heavy rain, snow, hail, etc. or poorly lit roadways at night)
- You are driving in a tunnel or next to a highway divider that interferes with the view of the camera(s)
- Bright light (such as from oncoming headlights or direct sunlight) interferes with the view of the camera(s).

The list above does not represent an exhaustive list of situations that may interfere with proper operation of Autopilot features. For more information, see [Limitations and Warnings on page 129](#).

NOTE: Depending on market region, vehicle configuration, options purchased, and software version, your vehicle may not be equipped with the following features, or a feature may not operate exactly as described.

Autopilot Feature	Available When
Traffic-Aware Cruise Control	<ul style="list-style-type: none"> • You are driving between 30 km/h and 140 km/h <p>NOTE: You can activate Traffic-Aware Cruise Control at lower speeds if there is a vehicle detected at least 1.5 meters ahead of Model Y.</p>
Autosteer	<ul style="list-style-type: none"> • You are driving between 30 km/h and 140 km/h <p>NOTE: You can activate Autosteer at lower speeds if there is a vehicle detected at least 1.5 meters ahead of Model Y.</p> <p>NOTE: On a residential road, a road without a center divider, or a road that is not controlled access, the maximum allowed cruising speed is limited and the touchscreen displays a message. The restricted speed will be the speed limit of the road plus 10 km/h.</p> <ul style="list-style-type: none"> • Headlights are set to On or Auto. Although Autopilot is available both during the day and in low light conditions (dusk or dark), Autosteer aborts or is unavailable if headlights are set to Off. When Autosteer is engaged, Auto High Beam is automatically enabled (see High Beam Headlights on page 82) and wipers are set to Auto.
Navigate on Autopilot	<ul style="list-style-type: none"> • You are driving between 30 km/h and 140 km/h. <p>NOTE: You can activate Navigate on Autopilot at lower speeds if there is a vehicle detected at least 1.5 meters ahead of Model Y.</p> <ul style="list-style-type: none"> • You are driving on a controlled-access highway. When you leave a controlled-access highway, Navigate on Autopilot reverts to Autosteer.



Autopilot Features

This topic describes how to enable and use the following driver assistance features.

NOTE: Depending on market region, vehicle configuration, options purchased, and software version, your vehicle may not be equipped with the following features, or a feature may not operate exactly as described.

- **Traffic-Aware Cruise Control:** Like traditional cruise control, Traffic-Aware Cruise Control maintains a set driving speed. However, Traffic-Aware Cruise Control also slows down or accelerates Model Y as needed to maintain the following distance from the vehicle in front of you. While Traffic-Aware Cruise Control is engaged, you are still responsible for steering Model Y (see [Traffic-Aware Cruise Control on page 108](#)).
 - **Autosteer:** Like Traffic-Aware Cruise Control, Autosteer maintains a set speed (if there is not a vehicle in front of you) or a set following distance (if there is a vehicle in front of you). In addition, Autosteer detects lane markings, road edges, and the presence of vehicles and objects to intelligently keep Model Y in its driving lane (see [Autosteer on page 109](#)).
- NOTE:** Autosteer is a BETA feature.
- **Auto Lane Change:** When you engage a turn signal while Autosteer is active, Auto Lane Change moves Model Y into the adjacent lane in the direction indicated by the turn signal (see [Auto Lane Change on page 110](#)).
 - **Navigate on Autopilot:** Navigate on Autopilot builds on the features of Traffic-Aware Cruise Control and Autosteer. While Autosteer is active, Navigate on Autopilot allows Model Y to suggest and, if configured, automatically change lanes to pass other vehicles and follow the navigation route (see [Navigate on Autopilot on page 111](#)).
- NOTE:** Navigate on Autopilot is a BETA feature.

Traffic-Aware Cruise Control and Autosteer use information from the cameras on Model Y to detect lane markings, road edges, and other vehicles and road users around Model Y.

CAUTION: Ensure all cameras are clean and free of obstructions before each drive and before using Autopilot features (see [Cleaning a Camera on page 192](#)). Dirty cameras and sensors (if equipped), as well as environmental conditions such as rain and faded lane markings, can affect Autopilot performance. If a camera is obstructed or blinded, Model Y displays a message on the touchscreen and Autopilot features may not be available. For more information on specific alerts, see [Troubleshooting Alerts on page 226](#).

CAUTION: It is your responsibility to familiarize yourself with the limitations of Autopilot and the situations in which driver intervention may be needed. For more information, see [Limitations and Warnings on page 129](#).

Autopilot Settings

Before you use Autopilot features, customize how they work by touching **Controls > Autopilot**.

- **Set Speed:** Choose whether Autopilot engages at the currently detected speed limit or your current driving speed. Touch **Controls > Autopilot > Set Speed** and choose either **Speed Limit** or **Current Speed**.
 - **Offset:** If you choose **Speed Limit**, you can specify an offset by touching **Set Speed Offset**. You can choose **Fixed** (the cruising speed adjusts by a specific amount on all roads) or **Percentage** (the cruising speed is adjusted as a percentage of the road's detected speed limit).
 - **Autopilot Activation:** Choose how to activate Autosteer. If set to **Single Pull**, both Traffic-Aware Cruise Control and Autosteer engage when you pull the drive stalk down once. If set to **Double Pull**, you must pull the drive stalk down twice in quick succession to engage Autosteer.
- NOTE:** **Autopilot Activation** must be set to **Double Pull** if you want to use Traffic-Aware Cruise Control independently of Autosteer.
- **Green Traffic Light Chime:** If on, a chime will sound when you are waiting at a red traffic light and the light turns green. If you are not actively using Traffic-Aware Cruise Control and are waiting at a red light with a car in front of you, the chime sounds when the car ahead of you advances.

Traffic-Aware Cruise Control

Traffic-Aware Cruise Control is always enabled.

To use Traffic-Aware Cruise Control:

1. Pull the drive stalk down once, then release the accelerator pedal to allow Traffic-Aware Cruise Control to maintain the cruising speed. A chime sounds to indicate that Traffic-Aware Cruise Control is now active.

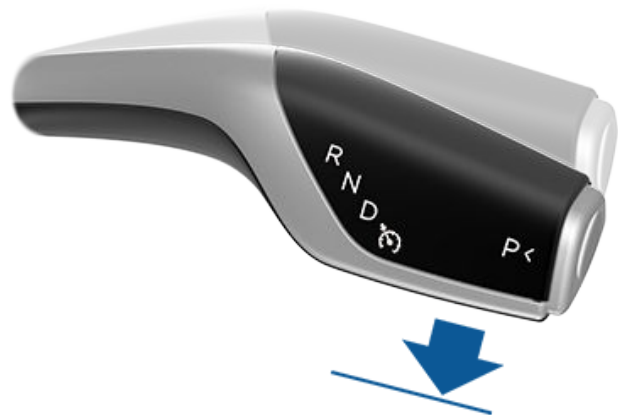

NOTE: If **Autopilot Activation** is set to **Single Pull**, pulling the drive stalk down once also activates Autosteer (which includes Traffic-Aware Cruise Control). Touch **Controls > Autopilot > Autopilot Activation** and choose **Double Pull** to use Traffic-Aware Cruise Control independently of Autosteer when you pull the drive stalk down once.



2. To change the set speed, roll the right scroll wheel up to increase, or down to decrease. You can apply the accelerator at any time to temporarily override the set cruising speed. For more information, see [While Using Autopilot on page 113](#).
3. To cancel Traffic-Aware Cruise Control, move the drive stalk upward or press the brake pedal. For more information, see [Canceling Autopilot on page 112](#).

**40
MAX** When Traffic-Aware Cruise Control is available but not engaged, the touchscreen displays the cruising speed in gray. The number shown represents the speed that will be set when you engage Traffic-Aware Cruise Control.

**40
MAX** When Traffic-Aware Cruise Control is actively cruising at a set speed, the speed is highlighted with blue text.

⚠ WARNING: Traffic-Aware Cruise Control is designed for your driving comfort and convenience and is not a collision warning or avoidance system. It is your responsibility to stay alert, drive safely, and be in control of the vehicle at all times. Never depend on Traffic-Aware Cruise Control to adequately slow down Model Y. Always watch the road in front of you and be prepared to take corrective action at all times. Failure to do so can result in serious injury or death. For more information, see [Limitations and Warnings on page 129](#).

Autosteer

NOTE: Depending on market region, vehicle configuration, options purchased, and software version, your vehicle may not be equipped with Autosteer, or the feature may not operate exactly as described.

To enable Autosteer:

1. Touch **Controls > Autopilot > Autopilot Features > Autosteer (Beta)**.
2. After carefully reading and understanding the popup window, touch **Yes**.

To use Autosteer:

1. Move the drive stalk fully down twice in quick succession.
NOTE: If the setting for **Autopilot Activation** is set to **Single Pull**, pulling the drive stalk down once engages Autosteer (see [Autopilot Settings on page 108](#)).

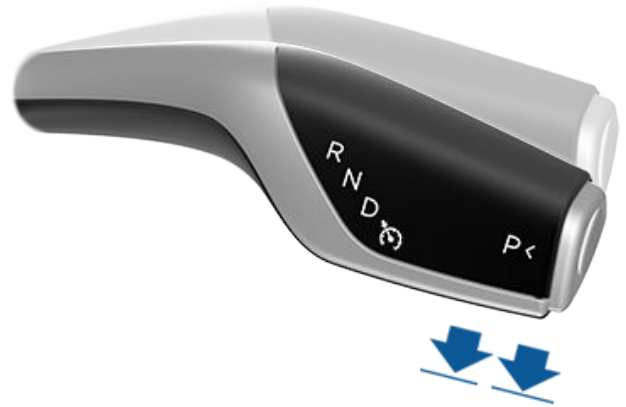

2. To change the set speed, roll the right scroll wheel up to increase, or down to decrease. For more information, see [While Using Autopilot on page 113](#).
3. To cancel Autosteer, move the drive stalk upward or press the brake pedal. For more information, see [Canceling Autopilot on page 112](#).

When you engage Autosteer, Model Y confirms activation with an audible chime and briefly displays a message on the touchscreen reminding you to pay attention to the road and have your hands on the steering wheel.



To indicate that Autosteer is available (but not actively steering Model Y), the top corner of the touchscreen displays a gray Autosteer icon next to the driving gear. In situations where Autosteer is temporarily unavailable, the Autosteer icon disappears. (For example, if your driving speed is not within the speed required for Autosteer to operate.)



To indicate that Autosteer is active, the touchscreen displays the Autosteer icon in blue.

When Autosteer is able to detect lane markings, it displays the edges of the driving lane in blue on the touchscreen.



Autopilot Features



- Auto Lane Change detected your hands on the steering wheel.
- Midway through the lane change, Model Y must detect the target lane's outside lane marking. If this lane marking is not detected, the lane change is aborted and Model Y returns to its original driving lane.
- The view of the camera(s) is not obstructed.
- Model Y does not detect a vehicle in its blind spot, or a vehicle or obstacle up to the center of the target lane. If a vehicle or other obstacle is detected in the target lane, it is shown in red in the visualization on the touchscreen and Model Y does not complete the lane change until it is safe to do so.



WARNING: Although Autopilot is designed to detect vehicles and obstacles in adjacent lanes, it is your responsibility to always perform visual checks to make sure it is safe and appropriate to move into the target lane. If Autopilot cannot change lanes due to inadequate data, the touchscreen displays a series of warnings. Therefore, when using Auto Lane Change, always pay attention to the touchscreen and be prepared to manually steer Model Y.

Whenever Autosteer is active, Traffic-Aware Cruise Control is active as well.

In situations where the speed limit cannot be detected when Autosteer is engaged, Autosteer reduces your driving speed and limits the set cruising speed to 70 km/h. Although you can manually accelerate to exceed the limited speed, Model Y will not brake for detected obstacles as long as you are applying the accelerator pedal. Autosteer slows down to the limited speed when you release the accelerator pedal. When you leave the road or disengage Autosteer by using the steering wheel, you can increase your set speed again, if desired.



WARNING: Autosteer is a hands-on assistance feature. Keep your hands on the steering wheel at all times, be mindful of road conditions and surrounding traffic, and always be prepared to take immediate action. Failure to follow these instructions could cause damage, serious injury or death. It is your responsibility to familiarize yourself with the limitations of Autosteer and the situations in which it may not work as expected. For more information, see [Limitations and Warnings on page 129](#).

Auto Lane Change

NOTE: Depending on market region, vehicle configuration, options purchased, and software version, your vehicle may not be equipped with Auto Lane Change, or the feature may not operate exactly as described.

If you engage a turn signal while Autosteer is active, Model Y moves into the adjacent lane in the direction indicated by the turn signal, provided the following conditions are met:

- The turn signal is engaged.
- Lane markings indicate that a lane change is permitted.

The minimum speed at which Autopilot changes lanes may vary depending on region, adjacent lane speeds, and other factors. Always be ready to manually steer and change lanes as necessary. When an automatic lane change is in progress, Overtake Acceleration is activated, allowing Model Y to accelerate closer to a vehicle in front (see [Overtake Acceleration on page 114](#)).

When you engage a turn signal, Autopilot moves Model Y one lane at a time. Moving into an additional lane requires you to engage the turn signal a second time after the first lane change is complete.

As Model Y changes lanes, it is important to monitor its performance by watching the driving path in front of you and the surrounding area. Stay prepared to take over steering at any time. As you are crossing over into the adjacent lane, the touchscreen displays the location in the lane that Model Y is moving into.

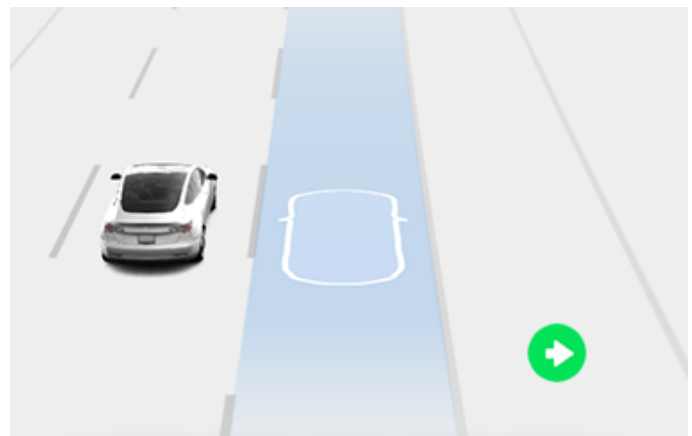



Navigate on Autopilot

NOTE: Depending on market region, vehicle configuration, options purchased, and software version, your vehicle may not be equipped with *Navigate on Autopilot*, or the feature may not operate exactly as described.

To enable *Navigate on Autopilot*, touch **Controls > Autopilot > Navigate on Autopilot (Beta)**. Then, to customize how you want *Navigate on Autopilot* to operate, touch **Customize Navigate on Autopilot**:

- **Enable at Start of Every Trip:** Choose whether to automatically enable *Navigate on Autopilot* for every navigation route. When enabled, the *Navigate on Autopilot* button on the turn-by-turn direction list is already enabled at the start of every trip.
- **Speed Based Lane Changes:** *Navigate on Autopilot* is designed to perform both route-based and speed-based lane changes. Speed-based lane changes are optional. You can use this setting to disable speed-based lane changes or to specify how assertively you want *Navigate on Autopilot* to change lanes to achieve the set cruising speed (**Mild**, **Average**, or **Mad Max**).
- **Exit Passing Lane:** Choose whether you want *Navigate on Autopilot* to maneuver out of a passing lane when navigating to a destination. In addition to route-based and speed-based lane changes, *Navigate on Autopilot* requests a lane change out of a passing lane as a reminder to stay in a slower lane when you are not passing other vehicles. Choose **No** to disable this and keep Model Y in a passing lane except when needed to stay on the navigation route.
- **Require Lane Change Confirmation:** (if equipped) By default, *Navigate on Autopilot* requires your confirmation before proceeding with a lane change by engaging the appropriate turn signal. If you do not confirm the lane change within 3 seconds, a chime sounds to remind you that *Navigate on Autopilot* requires your confirmation to change lanes.
- **Lane Change Notification:** You can specify if or how you want to be notified of lane changes (**Off**, **Chime**, **Vibrate**, or **Both**).

If **Enable at Start of Every Trip** is turned on, *Navigate on Autopilot* engages automatically when:

- Autosteer is active.
- You are navigating to a destination.
- You are on a controlled-access highway.

Once enabled, the *Navigate on Autopilot* button appears on the map's turn-by-turn direction list whenever a navigation route is active and the route includes at least one controlled-access highway.

If **Enable at Start of Every Trip** is turned off, touch the **Navigate on Autopilot** button above the turn-by-turn directions to enable it. Once the *Navigate on Autopilot* is selected, it will engage whenever you engage Autosteer.



The *Navigate on Autopilot* icon shows in the turn-by-turn direction list when you are navigating to a destination and *Navigate on Autopilot* is available but not active.



If *Navigate on Autopilot* is active, the icon is blue. If **Enable at Start of Every Trip** is turned on, the *Navigate on Autopilot* icon is selected whenever you start navigation. Touch the icon to cancel *Navigate on Autopilot* and revert to Autosteer.

Whenever *Navigate on Autopilot* is active, the *Navigate on Autopilot* button is blue and the touchscreen displays the driving lane as a single blue line in front of Model Y:

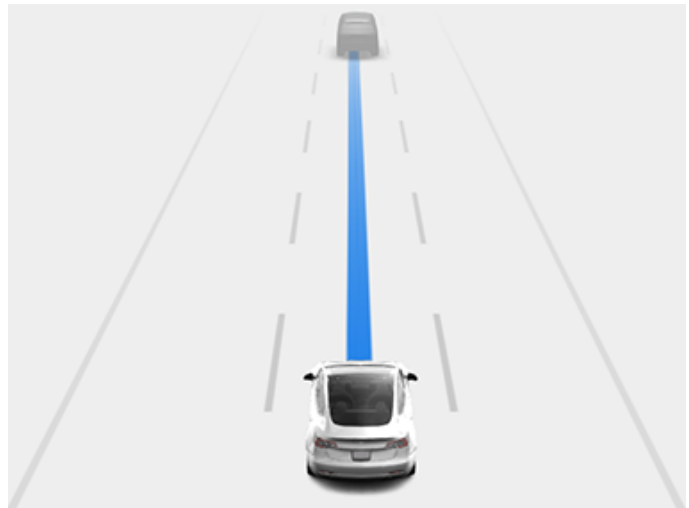

The turn-by-turn directions display the Autosteer icon next to the maneuvers (such as off-ramps) that *Navigate on Autopilot* will handle.

When *Navigate on Autopilot* is engaged Model Y automatically makes both speed-based and route-based lane changes.

- **Speed Based Lane Changes:** *Navigate on Autopilot* changes lanes to reduce driving time to your destination. For example, if Model Y is behind a vehicle going below the set cruising speed, *Navigate on Autopilot* will move into the passing lane to pass it. Speed-based lane changes are optional.
- **Route Based Lane Changes:** *Navigate on Autopilot* changes lanes to route you to your destination. For example, *Navigate on Autopilot* will move into the exit lane as Model Y approaches the off-ramp specified by the navigation route.

If you ignore a route-based lane change suggestion (for example, you are driving in the left lane while approaching an off-ramp on the right side of the highway), *Navigate on Autopilot* is unable to maneuver onto the off-ramp and as a result, you are re-routed to your destination.



Autopilot Features

CAUTION: Navigate on Autopilot may not always attempt to exit at an off-ramp or change lanes, even when an exit or lane change is determined by the navigation route. Always remain alert and be prepared to manually steer onto an off-ramp, or make a lane change to prepare for, or to exit at, an off-ramp or interchange.

Navigate on Autopilot activates and deactivates based on the type of road you are driving on. When Navigate on Autopilot is active and you approach an off-ramp or interchange along your navigation route, the appropriate turn signal engages and Autosteer maneuvers Model Y onto the off-ramp or interchange.

When you leave a controlled-access highway Navigate on Autopilot reverts to Autosteer—a chime sounds and the touchscreen displays the driving lane lines in blue (instead of the single blue in front of Model Y). When Navigate on Autopilot deactivates, Autosteer remains active. Always be prepared to take appropriate action.

WARNING: Navigate on Autopilot is a hands-on feature. Keep your hands on the steering wheel at all times, be mindful of road conditions and surrounding traffic, and always be prepared to take immediate action. Failure to follow these instructions could cause damage, serious injury or death. It is your responsibility to familiarize yourself with the limitations of Navigate on Autopilot and the situations in which it may not work as expected. For more information, see [Limitations and Warnings on page 129](#).

Canceling Autopilot

Traffic-Aware Cruise Control cancels when:

- You move the drive stalk upward.
 - **CAUTION:** If you move the drive stalk upward and hold it up for more than one second, Model Y shifts into Neutral after canceling Autosteer.
- You press the brake pedal.
- You exceed 150 km/h.
- You shift into Reverse, Park, or Neutral.
- A door is opened.
- An Automatic Emergency Braking event occurs (see [Collision Avoidance Assist on page 137](#)).
- The driver's seatbelt is released, and/or the driver gets out of their seat.



When Traffic-Aware Cruise Control cancels, the cruising speed icon on the touchscreen turns gray to indicate that Traffic-Aware Cruise Control is no longer active.

Autosteer cancels when any of the above actions are taken. In addition, Autosteer cancels when:

- You exceed 140 km/h.
- You take over steering manually.

WARNING: If **Autopilot Activation** is set to **Double Pull** and Autosteer cancels because you started steering manually, Traffic-Aware Cruise Control remains active. If **Autopilot Activation** is set to **Single Pull** and Autosteer cancels because you started steering manually, Traffic-Aware Cruise Control also cancels.

- You do not respond to repeated reminders to keep your hands on the wheel and subsequent messages on the touchscreen (see [Driver Attentiveness on page 115](#)).

When Autosteer cancels, a chime sounds and the Autosteer icon either turns gray to indicate that Autosteer is no longer active, or disappears to indicate that it is not currently available.

Navigate on Autopilot cancels when Autosteer cancels, as described above. In addition, Navigate on Autopilot cancels when:

- You touch the Navigate on Autopilot button on the map's turn-by-turn direction list. In this case, Autosteer is still active.
- You leave a controlled-access highway. When this happens, Autosteer is still active.

When Navigate on Autopilot cancels but Autosteer remains active, a chime sounds and the visualization goes from a single blue line in the driving lane to two blue lines on either side of the lane.



When Traffic-Aware Cruise Control or Autosteer cancels, Model Y does not coast. Instead, regenerative braking slows down Model Y in the same way as when you move your foot off the accelerator when driving without Traffic-Aware Cruise Control (see [Regenerative Braking on page 86](#)).

While Using Autopilot

When Traffic-Aware Cruise Control is active and Autopilot is maintaining a set speed, the speed is highlighted with blue text on the touchscreen.

When Autosteer is active, the steering wheel icon is blue and the lane markings are highlighted in blue on the visualization. If Navigate on Autopilot is also active, the Navigate on Autopilot button is blue and the touchscreen displays the driving lane as a single blue line in front of Model Y.

To display more details about the roadway and its surroundings, such as road markings, stop lights, and objects (such as trash cans and poles), touch **Controls > Autopilot > Full Self-Driving Visualization Preview**.

If unable to detect lane markings, Autosteer may determine the driving lane based on a vehicle you are following. In most cases, Autosteer attempts to center Model Y in the driving lane. However, there may be situations in which Autosteer follows a driving path that is offset from the center of the lane (for example, if guard rails are detected).

Maintaining the Set Speed

When Autopilot is active, Model Y maintains your set cruising speed whenever a vehicle is not detected in front of it. When cruising behind a vehicle, Model Y accelerates and decelerates as needed to maintain a chosen following distance (see [Adjusting the Following Distance on page 113](#)), up to the set speed.

You can manually accelerate at any time by pressing the accelerator pedal, but when you release the pedal Model Y resumes cruising at the set speed.

Model Y also adjusts the cruising speed when entering and exiting curves.

When Model Y is actively slowing down to maintain the selected distance from the vehicle ahead, brake lights turn on. You may notice slight movement of the brake pedal. However, when Model Y is accelerating, the accelerator pedal does not move.

Changing the Set Speed

Roll the right scroll wheel up to increase, or down to decrease, the set speed.

You can also change the cruising speed to the current speed limit (including any offset you've specified), by either:

- Pushing the drive stalk downward and briefly holding.

- Touching and briefly holding the speed limit sign on the touchscreen until you see the cruising speed change.



It may take a few seconds for Model Y to reach the new cruising speed.

Adjusting the Following Distance

To adjust the following distance you want to maintain between Model Y and a vehicle traveling ahead of you, press the steering wheel's right scroll button to the left or right.

The closest following distance is 2.

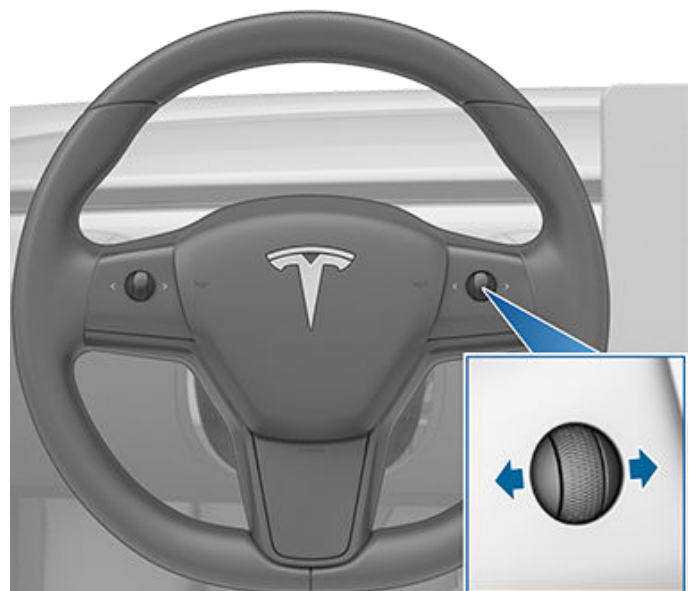

Each setting corresponds to a time-based distance that represents how long it takes for Model Y, from its current location, to reach the location of the rear bumper of the vehicle ahead of you. Autopilot retains your setting until you change it again.



Autopilot Features

As you adjust the following distance, the touchscreen displays the current setting.

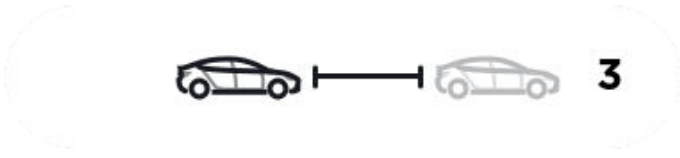

Stopping and Slowdowns

When moving significantly faster than vehicles in adjacent lanes, Model Y automatically reduces the driving speed. This is especially helpful in heavy traffic situations or when vehicles are constantly merging into different lanes. When Model Y detects other vehicles driving significantly slower, the touchscreen highlights the adjacent lanes with arrows and detected vehicles in gray, and Model Y reduces the driving speed as appropriate. To temporarily override this feature, press the accelerator pedal.

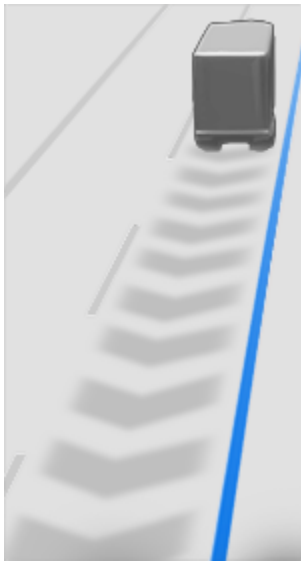

When following a vehicle, Autopilot remains active at low speeds, even when Model Y comes to a full stop. For example, Autopilot remains active even if Model Y slows down to a complete or near-complete stop in heavy, stop-and-go traffic on a highway. When traffic starts moving more rapidly, Autopilot again accelerates up to the set speed.

Sometimes when Model Y is at a full stop, Autopilot goes into a HOLD state. If this happens, briefly press the accelerator pedal to resume cruising.



When the HOLD status is active, the touchscreen displays the HOLD icon and a message that indicates that you need to resume cruise control.

Model Y goes into HOLD state while Autopilot is active in the following circumstances:

- Model Y has been at a standstill for 5 minutes.

- Model Y detects a pedestrian (the HOLD state may clear when the pedestrian is no longer detected).
- Model Y suddenly loses visibility of the vehicle in front of you.
- An obstacle is detected in front of Model Y.

Cruising Near or On Exits

When you are cruising near an exit on a controlled-access highway and engage the turn signal toward the off-ramp, Autopilot assumes you are exiting and begins to slow down Model Y. If you do not drive onto the off-ramp, Autopilot resumes cruising at the set speed.

In a region with right hand traffic, this occurs only when you engage the right turn signal when driving in the right-most lane within 50 meters of an exit. Likewise in regions with left hand traffic, this occurs when engaging the left turn signal when driving in the left-most lane within 50 meters of an exit.

NOTE: If Navigate on Autopilot is active, Model Y will perform a route-based lane change to enter the exit lane and take the off-ramp as necessary to follow the navigation route.

When cruising onto an on-ramp to a controlled-access highway, Autopilot automatically adjusts the set cruising speed to the speed limit of the highway, plus any offset you have specified. If Navigate on Autopilot is engaged, it disengages as you leave the controlled-access highway (see [Canceling Autopilot on page 112](#)). In this case, Autosteer remains active.

Overtake Acceleration

Engage the turn signal momentarily to accelerate Model Y towards the vehicle ahead of it. By momentarily holding the turn signal stalk up or down, you can quickly accelerate up to your set speed without having to press the accelerator pedal as long as:

- Traffic-Aware Cruise Control is operating and detects a vehicle in front of you.
- No obstacles or vehicles are detected in the target lane.
- Model Y is traveling below the set speed, but over 72 km/h.

NOTE: If Autosteer is active and you fully engage the turn signal, Model Y will change lanes automatically (see [Auto Lane Change on page 110](#)).

Model Y stops accelerating when you reach your set cruising speed, if changing lanes takes too long, or if Model Y gets too close the vehicle ahead. Model Y also stops accelerating if you disengage the turn signal.

Stop Light and Stop Sign Warning

While Autopilot is in use, Model Y displays a warning on the touchscreen and sounds a chime if it detects that you are likely to run through a red stop light or stop sign. If this happens, **TAKE IMMEDIATE CORRECTIVE ACTION!**



The visual and audible warnings cancel after a few seconds or when you press the brake pedal, whichever comes first.

Stop Light and Stop Sign Warning provides warnings only. It does not slow down or stop Model Y at red traffic lights, stop signs, road markings, etc. If equipped with Traffic Light and Stop Sign Control, you can enable this feature to automatically stop Model Y at traffic lights and stop signs (see [Traffic Light and Stop Sign Control on page 116](#)).

Emergency Vehicles

If available in your market region, Model Y automatically reduces driving speed when lights from an emergency vehicle are detected when using Autosteer at night on a high speed road. When this happens, the touchscreen displays a message informing you of the slowdown. You will also hear a chime, and see a reminder to keep your hands on the steering wheel. When the light detections pass by or cease to appear, Autopilot resumes your cruising speed. Alternatively, you may tap the accelerator to resume your cruising speed.

Never depend on Autopilot features to determine the presence of emergency vehicles. Model Y may not detect lights from emergency vehicles. Keep your eyes on your driving path and always be prepared to take immediate action.

Driver Attentiveness

Autosteer determines how best to steer Model Y. When active, Autosteer requires you to hold the steering wheel. If it does not detect your hands on the steering wheel for a period of time, a flashing blue light appears at the top of the vehicle status section of the touchscreen and the following message displays:



Apply slight turning force to steering wheel

When your hands are detected, the message disappears and Autosteer resumes normal operation. Autosteer detects your hands by recognizing slight resistance as the steering wheel turns, or from you manually turning the steering wheel very lightly (without enough force to take over steering). Autosteer also qualifies your hands as being detected if you engage a turn signal or use a button or scroll wheel on the steering wheel.

Autosteer requires that you pay attention to your surroundings and remain prepared to take control at any time. If Autosteer still does not detect your hands on the steering wheel, the flashing light on the vehicle status section of the touchscreen increases in frequency and a chime sounds.

If you repeatedly ignore Autosteer's prompts to apply slight force to the steering wheel, Autosteer disables for the rest of the drive and displays the following message requesting you to drive manually.



Autopilot unavailable for current drive. Autopilot Strikeout - Attention warnings ignored.

For the rest of the drive, you must steer manually. Autosteer is available again on your next drive (after you stop and shift Model Y into Park).

If you don't resume manual steering, Autosteer sounds a continuous chime, turns on the warning flashers, and slows the vehicle to a complete stop.

Autopilot Suspension

Use of Autopilot features will be suspended if improper usage is detected.

Use of Autosteer is suspended for a week when you or another driver of your vehicle receives five Autopilot "strikeouts." A strikeout is when the Autopilot system disengages for the remainder of a trip after the driver receives several audio and visual warnings for inattentiveness.

You can see how many strikeouts are remaining before Autopilot access is suspended by touching **Controls > Autopilot**.

A strikeout is forgiven after 7 days, as long as you don't receive another strikeout in that time.

NOTE: If your access to Autosteer is suspended, you can still use Traffic-Aware Cruise Control and all active safety features are still enabled.

There may be occasions where driver intervention is required and you must take over immediately to maintain safe driving. Driver-initiated disengagements do not count as improper usage and are expected from the driver.



Traffic Light and Stop Sign Control

NOTE: Depending on market region, vehicle configuration, options purchased, and software version, your vehicle may not be equipped with Traffic Light and Stop Sign Control, or the feature may not operate exactly as described.

NOTE: Traffic Light and Stop Sign Control is a BETA feature and works best on roads that are frequently driven by Tesla vehicles. Traffic Light and Stop Sign Control attempts to stop at all traffic lights and may also stop at green lights.

Traffic Light and Stop Sign Control is designed to recognize and respond to traffic lights and stop signs, slowing Model Y to a stop when using Traffic-Aware Cruise Control or Autosteer. This feature uses the vehicle's forward-facing cameras, in addition to GPS data, and slows the car for all detected traffic lights, including green, blinking yellow, and off lights in addition to stop signs and some road markings. As Model Y approaches an intersection, the touchscreen displays a notification indicating the intention to slow down. You must confirm that you want to continue or Model Y stops at the red line displayed on the touchscreen's driving visualization.

WARNING: NEVER make assumptions and predict when and where Traffic Light and Stop Sign Control will stop or continue through an intersection or road marking. From a driver's perspective, the behavior of Traffic Light and Stop Sign Control may appear inconsistent. Always pay attention to the roadway and be prepared to take immediate action. It is the driver's responsibility to determine whether to stop or continue through an intersection. Never depend on Traffic Light and Stop Sign Control to determine when it is safe and/or appropriate to stop or continue through an intersection.

Before Using

Before using Traffic Light and Stop Sign Control, you must:

- Ensure that forward-facing cameras are unobstructed (see [Cleaning a Camera on page 192](#)) and calibrated (see [Drive to Calibrate Cameras on page 16](#)). Traffic Light and Stop Sign Control depends on the ability of the cameras to detect traffic lights, stop signs, and road markings.
- Ensure that the latest version of maps has been downloaded to Model Y. Although Traffic Light and Stop Sign Control primarily uses visual data received from the vehicle's cameras, greater accuracy is achieved when using the most recent map data. To check which version of maps is currently downloaded, touch **Controls > Software**. You must connect to a Wi-Fi network to receive updated maps (see [Map Updates on page 164](#)).
- Enable the feature. With the vehicle in Park, touch **Controls > Autopilot > Traffic Light and Stop Sign Control**. Once enabled, Traffic Light and Stop Sign Control operates whenever Traffic-Aware Cruise Control or Autosteer is active.

How it Works

When Traffic Light and Stop Sign Control is enabled and you are using Autosteer, Traffic-Aware Cruise Control, or Full Self-Driving (Supervised), the touchscreen displays a popup message to inform you that an upcoming traffic light, stop sign, or road marking has been detected. As it approaches the stop location, **even at an intersection where the traffic light is green**, Model Y slows down and displays a red line to indicate where Model Y will stop. To continue through the intersection—even if the traffic light is green—you must press down on the drive stalk or briefly press the accelerator pedal to give the vehicle permission to proceed. When you've confirmed that you want to proceed, the red stop line turns gray and Model Y continues through the intersection and resumes your set cruising speed.

NOTE: If Model Y is approaching a green light and detects that a vehicle in front of you is continuing through the intersection, Model Y continues through the intersection without requiring your confirmation, provided you are not in a turning lane and the vehicle can detect that your hands are on the steering wheel.







NOTE: If, after you press down on the drive stalk or briefly press the accelerator pedal to confirm that you want to continue through the intersection, the traffic signal changes before you enter the intersection (for example, the light changes from green to yellow or from yellow to red), Model Y may determine that it is not appropriate to proceed. Therefore, Model Y stops and you must press the accelerator to proceed. At all times, it is your responsibility to ensure the vehicle stops or accelerates appropriately and safely.

WARNING: Traffic Light and Stop Sign Control DOES NOT turn Model Y through an intersection unless Full Self-Driving (Supervised) is engaged. When in a turning lane, Model Y stops at the red stop line. To proceed, press down on the drive stalk or briefly press the accelerator pedal—Model Y continues *straight* through the intersection (even when in a turning lane), so you MUST manually steer Model Y through the intersection (which cancels Autosteer).

Traffic Light and Stop Sign Control is designed to operate as described only when the following conditions are met:

- Autosteer, Full Self-Driving (Supervised), or Traffic-Aware Cruise Control is engaged.
- The cameras can detect an upcoming traffic light, stop sign or road marking (for example, cameras are unobstructed and have a clear line-of-sight to the traffic light, stop sign, or road marking).
- The touchscreen on Model Y is displaying an upcoming traffic light in "bold" format. Model Y does not acknowledge traffic lights that the touchscreen shows as faded. If a traffic light is not directly ahead of the camera (for example, it is located at an angle of the camera's view, or located in an adjacent lane) the touchscreen displays it as faded and Model Y does not slow down and stop for it.





-  **WARNING:** If the touchscreen is not displaying a red stop line at an upcoming intersection, Model Y does not slow down or stop. It is the driver's responsibility to pay attention to upcoming intersections and monitor traffic conditions to determine when and if the vehicle should stop and then to take appropriate action as needed.
-  **WARNING:** Never depend on Traffic Light and Stop Sign Control to determine whether to stop at, or proceed through, an intersection. Drive attentively by watching the road and paying attention to the roadway, upcoming intersections, traffic conditions, crosswalks, and other road users. It is always the driver's responsibility to determine whether to stop or proceed. Be prepared to take immediate action. Failure to do so can result in injury or death.
-  **WARNING:** In some situations, Traffic Light and Stop Sign Control may inaccurately detect a traffic light or stop sign, causing Model Y to slow down unexpectedly. Be prepared to take immediate action at all times.
-  **WARNING:** You must press down on the drive stalk or briefly press the accelerator pedal to confirm that you want to proceed through an intersection, regardless of the status of the traffic light. If you do not confirm, Model Y stops at the red stop line displayed on the touchscreen, even if stopping may be inappropriate. Stopping at a green light may confuse other drivers and may result in a collision, injury or death. Therefore, always pay attention to upcoming intersections and be prepared to manually brake or accelerate in response to surroundings.
-  **WARNING:** Never assume that your ability to see a traffic light, stop sign, or road marking (especially at a complex intersection, or an intersection in which a traffic light or sign is partially obstructed, etc.) means that Model Y can also see it and respond appropriately.
-  **WARNING:** Even the most recent map data does not include all traffic lights and stop signs. Therefore, Traffic Light and Stop Sign Control relies heavily on the ability of the cameras to detect traffic lights, stop signs, road markings, etc. As a result, Model Y may ignore an intersection that is blocked from the camera's view (for example, obstructed by a tree or a large vehicle or object, or located near a steep hill or sharp curve).
-  **WARNING:** Traffic Light and Stop Sign Control is not a substitute for attentive driving and sound judgment.





Traffic Light and Stop Sign Control

Traffic Lights

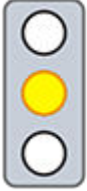
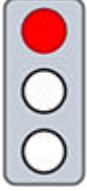
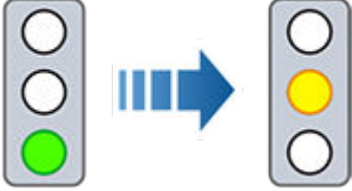
When driving with Autosteer or Traffic-Aware Cruise Control engaged, and Traffic Light and Stop Sign Control enabled, Model Y is designed to respond as follows when approaching intersections controlled by a traffic light:

Type of Traffic Light	Vehicle Intended Response
 	<p>At a solid green traffic light, or at a traffic light that is currently off (not illuminated), Model Y slows down.</p> <p>If you are following a car in front of you that continues through the intersection, the touchscreen displays a green stop line and provided your hands are detected on the steering wheel, Model Y also continues. If a car is not in front of you, the touchscreen displays a red stop line and you must confirm that you want to continue through the intersection by press down on the drive stalk or briefly pressing the accelerator pedal. If you don't confirm, Model Y stops at the red stop line.</p> <p>NOTE: Model Y resumes the set cruising speed when it continues through the intersection, taking into consideration the speed of a vehicle in front of you.</p>
 	<p>Model Y slows down and comes to a complete stop at the red stop line displayed on the touchscreen. When you want to continue through the intersection (for example, the light turns green again, or once Model Y has come to a complete stop), you must press down on the drive stalk or briefly press the accelerator pedal.</p>
	<p>Model Y slows down and comes to a complete stop at the red stop line displayed on the touchscreen. When you want to proceed through the intersection (for example, the light turns green again), you must press down on the drive stalk or briefly press the accelerator pedal.</p> <p>NOTE: If the traffic light changes <i>after</i> you've confirmed that you want to proceed (for example, a green traffic light turns yellow), Model Y may stop instead of continuing, especially if Model Y determines that it can safely stop before entering the intersection.</p> <p>NOTE: Model Y is not designed to proceed through an intersection when the traffic light is red or if the light turns yellow in situations when there is adequate distance to safely stop before entering the intersection.</p> <p>NOTE: You can take over driving at any time by manually braking to cancel Autosteer or Traffic-Aware Cruise Control.</p>

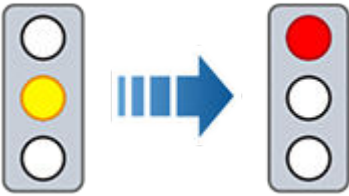
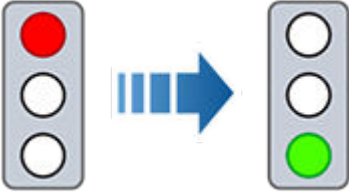

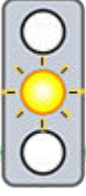
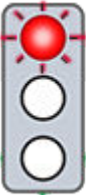

Type of Traffic Light	Vehicle Intended Response
 	
 	<p>Model Y slows down. To proceed, you must press down on the drive stalk or briefly press the accelerator pedal. If you don't, Model Y stops at the red stop line displayed on the touchscreen.</p> <p>NOTE: To prevent Model Y from stopping, and to minimize how much it slows down as it approaches, you can confirm that you want to proceed by press down on the drive stalk or briefly pressing the accelerator pedal at any time after the touchscreen displays the red stop line. Model Y resumes your set cruising speed immediately after you confirm (taking into consideration the speed of a vehicle in front of you).</p> <p>⚠ WARNING: Approach attentively and be prepared to press the brake pedal to slow down or stop.</p>
	<p>Model Y slows down and comes to a complete stop at the red stop line displayed on the touchscreen. When you want to proceed through the intersection (for example, traffic laws and conditions indicate it is safe and legal to proceed), you must press down on the drive stalk or briefly press the accelerator pedal.</p>



Traffic Light and Stop Sign Control

Stop Signs and Road Markings

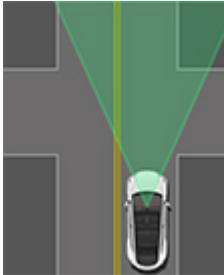
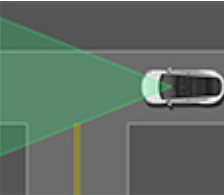
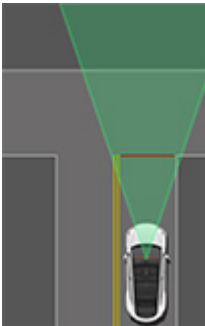
When driving with Autosteer or Traffic-Aware Cruise Control engaged, and Traffic Light and Stop Sign Control enabled, Model Y is designed to respond as follows when approaching intersections controlled by stop signs, stop lines, or road markings:

Type of Intersection	Vehicle Intended Response
 <p data-bbox="159 747 362 779">No Traffic Control</p>  <p data-bbox="159 1031 362 1062">Arm of T-junction</p>	<p data-bbox="435 447 1442 478">Model Y assumes the right of way and continues straight without slowing down or stopping.</p>
 <p data-bbox="164 1459 360 1491">End of T-junction</p>	<p data-bbox="435 1104 1450 1188">If Model Y detects a T-junction based on the map data, Model Y slows down and comes to a complete stop at the red stop line displayed on the touchscreen. When you want to proceed, you must take over steering and acceleration.</p> <p data-bbox="435 1203 1450 1287">⚠ WARNING: Model Y may not stop at a T-junction that does not have a stop sign or stop line, or if the T-junction is not included in the map data. Drive attentively and be prepared to stop (when necessary and/or appropriate).</p>
 <p data-bbox="204 1887 316 1919">Stop Sign</p>	<p data-bbox="435 1535 1433 1619">Model Y slows down and comes to a complete stop at the red stop line displayed on the touchscreen. When you want to proceed through the intersection, you must press down on the drive stalk or briefly press the accelerator pedal.</p> <p data-bbox="435 1633 1466 1749">NOTE: If you confirm that you want to proceed through an intersection controlled by a stop sign by press down on the drive stalk or briefly pressing the accelerator pedal before Model Y has stopped, your confirmation is ignored. Model Y is not designed to proceed through a stop sign without stopping.</p> <p data-bbox="435 1764 1450 1816">NOTE: Even when using Autosteer, and even if you have engaged a turn signal, you must turn the steering wheel yourself (which cancels Autosteer) to complete a turn at an intersection.</p>

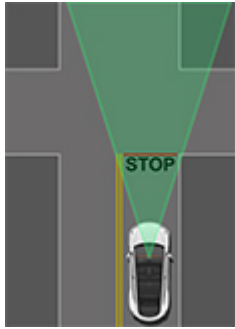

Type of Intersection	Vehicle Intended Response
 <p data-bbox="151 569 464 596">Stop Sign and Road Marking</p>	
 <p data-bbox="232 978 386 1005">Road Marking</p>	

- ⚠ WARNING:** Model Y also slows down and stops at a roundabout. You must take over steering (which cancels Autosteer) and press down on the drive stalk or briefly press the accelerator pedal to confirm that you want to continue through the roundabout.
- ⚠ WARNING:** At crosswalks, Model Y may slow down and may stop, depending on whether the crosswalk is controlled by a traffic light and whether the cameras detect pedestrians, bicyclists, etc. in the crosswalk. Pay particular attention at crosswalks and be prepared to take over at any time. Failure to do so can result in injury or death.

Limitations

Depending on many different circumstances and environmental conditions, Traffic Light and Stop Sign Control *may or may not* stop at:

- Railroad crossings.
- Keep-out zones.
- Toll booths.
- Crosswalk systems.
- Yield signs or temporary traffic lights and stop signs (such as at construction areas).
- Miscellaneous traffic U-turn lights, bicycle and pedestrian crossing lights, lane availability lights, etc.

In addition, Traffic Light and Stop Sign Control is particularly unlikely to operate as intended, can disengage, or may not operate, when one or more of the following conditions are present:

- Driving through consecutive light-controlled intersections that are very close to each other.
- Visibility is poor (heavy rain, snow, fog, etc.) or weather conditions are interfering with camera or sensor operation.
- Bright light (such as direct sunlight) is interfering with the view of the camera(s).
- A camera is obstructed, covered, damaged, or not properly calibrated.



Traffic Light and Stop Sign Control

- Driving on a hill or on a road that has sharp curves on which the cameras are unable to see upcoming traffic lights or stop signs.
- A traffic light, stop sign, or road marking is obstructed (for example, a tree, a large vehicle, etc.).
- Model Y is being driven very close to a vehicle in front of it, which is blocking the view of a camera.

 **WARNING:** The limitations listed above are not an exhaustive list of reasons why Model Y may not operate as expected. Many unforeseen circumstances can adversely impact the accurate operation of Traffic Light and Stop Sign Control. Using this feature does not reduce or eliminate the need to drive attentively and responsibly. You must be prepared to take appropriate and immediate action at all times.

NOTE: Depending on market region, vehicle configuration, options purchased, and software version, your vehicle may not be equipped with Autopark.

Autopark uses data to simplify parking on public roads by maneuvering Model Y into parallel and perpendicular parking spaces.

NOTE: Autopark is unavailable when Traffic-Aware Cruise Control is enabled. To use Autopark, enable Autosteer by touching **Controls > Autopilot**.

If your access to Autosteer is suspended, you also lose access to Autopark. For more information, see [Autopilot Suspension on page 115](#).

WARNING: It is your responsibility to familiarize yourself with the limitations of Autopark and the situations in which it may not work as expected. For more information, see [Limitations and Warnings on page 129](#).

WARNING: Do not use Autopark if anything, such as a ball hitch, bike rack, or trailer, is attached to the tow hitch. Autopark may not stop for hitches when parking between or in front of other vehicles.

CAUTION: Autopark's performance depends on the ability of the cameras to determine the vehicle's proximity to curbs, objects, and other vehicles. Ensure all cameras are clean and free of obstructions before each drive and before using Autopilot features (see [Cleaning a Camera on page 192](#)). Dirty cameras and sensors (if equipped), as well as environmental conditions such as rain and faded lane markings, can affect Autopilot performance. If a camera is obstructed or blinded, Model Y displays a message on the touchscreen and Autopilot features may not be available. For more information on specific alerts, see [Troubleshooting Alerts on page 226](#).

Parameters

Autopark detects potential parking spaces based on the following parameters:

Perpendicular Parking

- Your driving speed must be below 13 km/h. If driving too fast, Autopark may not be able to accurately detect your desired parking space.
- The parking space must be at least as wide as your vehicle.
- The parking space must have at least three visible lines for the vehicle to park into, such as parking lines, road markings, or distinct curbs. Autopark may not work in a garage, for example, without three visible parking lines.

Parallel Parking

- Your driving speed must be below 13 km/h. If driving too fast, Autopark may not be able to accurately detect your desired parking space.

- There must be a vehicle in front of or behind the space you want to park in.

NOTE: Autopark does not operate on angled parking spaces.

To Use Autopark

When driving, follow these steps to allow Autopark to maneuver Model Y into a parking space:

1. While driving slowly, monitor the touchscreen to see potential parking spaces detected by Autopilot. When Model Y is positioned such that it can reverse into one of the detected locations, the touchscreen displays potential open parking spaces.



NOTE: The detected parking spaces appear only if the vehicle's position and/or the circumstances of the surrounding area are such that Autopark can determine an appropriate driving path. If Autopark cannot determine an appropriate path (for example, when driving on a narrow street where moving into the parking space causes the front of the vehicle to extend into the adjacent lane), you can either reposition the vehicle, find a different parking space, or park manually.

2. Choose a spot. Check to determine if it is appropriate and safe, then pull forward and stop approximately one car length ahead of the parking space (as you normally would when parallel parking or when backing into a perpendicular parking space).
3. Release the steering wheel, then touch **Start** on the touchscreen.



4. Autopark displays a message when parking is complete.

If you press the brake pedal when Autopark is actively parking Model Y, the parking process pauses until you touch **Resume** on the touchscreen.

 **WARNING:** Never depend on Autopark to find a parking space that is legal, suitable, and safe. Autopark may not always detect objects in the parking space. Always perform visual checks to confirm that a parking space is appropriate and safe.

 **WARNING:** When Autopark is actively steering Model Y:

- Do not interfere with the movement of the steering wheel. Doing so cancels Autopark.
- Continually check your surroundings. Be prepared to apply the brakes to avoid vehicles, pedestrians, or objects.
- Monitor the touchscreen to ensure that you are aware of the instructions that Autopark is providing.

To Pause Parking

To pause Autopark, press the brake pedal once. Model Y stops and remains stopped until you touch **Resume** on the touchscreen.

To Cancel Parking

Autopark cancels the parking sequence when you manually move the steering wheel, shift, or touch **Cancel** on the touchscreen. Autopark also cancels parking when:

- The parking sequence exceeds seven moves.
- Model Y detects that the driver is exiting the vehicle.
- A door is opened.
- You press the accelerator pedal.
- You press the brake pedal while Autopark is paused.
- An Automatic Emergency Braking event occurs (see [Collision Avoidance Assist on page 137](#)).



This feature may be temporarily limited or inactive until it is enabled with a future software update for vehicles manufactured as of approximately mid-February 2024.

NOTE: Depending on market region, vehicle configuration, options purchased, and software version, your vehicle may not be equipped with Summon, or the feature may not operate exactly as described.

Summon allows you to automatically park and retrieve Model Y while you are standing outside the vehicle. Summon moves Model Y forward and reverse up to 12 meters in, or out of, a parking space.

To move Model Y a longer distance while steering around objects, you can use Smart Summon (if equipped) and your mobile phone. Smart Summon allows your vehicle to find you (or you can send your vehicle to a chosen location). See [Smart Summon on page 127](#).

Summon requires that Model Y can detect a valid key nearby.

-  **WARNING:** Summon is designed and intended for use only on parking lots and driveways on private property where the surrounding area is familiar and predictable.
-  **WARNING:** Summon is a BETA feature. You must continually monitor the vehicle and its surroundings and stay prepared to take immediate action at any time. It is the driver's responsibility to use Summon safely, responsibly, and as intended. For more information about the limitations of Summon and conditions that may interfere with its use, see [Warnings and Limitations on page 129](#).

Before Using Summon

Before operating Summon, use the touchscreen to enable it and customize how you want it to work. Touch **Controls** > **Autopilot** > **Customize Summon** and adjust the following settings to suit your preferences:

- **Bumper Clearance:** Set the distance that you want Summon to stop from a detected object (for example, you may want Summon to stop within just a few inches of a garage wall). Note that this distance applies only to objects that Summon detects directly in front of Model Y when moving forward, or directly behind Model Y when reversing.
- **Summon Distance:** Set a maximum distance that Model Y can travel when entering or exiting a parking space.
- **Side Clearance:** Choose an option to specify how much side clearance you want to allow. **Tight** allows Model Y to enter and exit very narrow parking spaces.

 **WARNING:** Parking in a narrow space limits the ability of the cameras and sensors (if equipped) to accurately detect the location of obstacles, increasing the risk of damage to Model Y and/or surrounding objects.

- **Require Continuous Press:** By default, Summon requires that you press and hold a button on the mobile app to move Model Y during the parking process. When **Require Continuous Press** is set to **No**, you can press and release the button—you don't need to hold it down to keep the vehicle moving. Also, when **Require Continuous Press** is set to **No**, you can operate Summon using the key fob accessory instead of the mobile app (see [#unique_363 on page](#)) and you can start a parking sequence from inside the vehicle (see [Starting Summon Before Exiting the Vehicle on page 126](#)).
- **Use Auto HomeLink** (if equipped): Set to **ON** if you want to activate HomeLink to open/close a programmed HomeLink device (such as a gate or a garage door) during the parking process when using Summon. If enabled, the device automatically opens and closes when Model Y enters or exits during a Summon session. In a Smart Summon session (if equipped), the device automatically opens when, at the beginning of a session, Smart Summon detects that Model Y is parked in a garage.

 **WARNING:** Always ensure that Model Y is fully in or out of a garage before HomeLink lowers the garage door. Summon and Smart Summon (if equipped) cannot detect where an overhead door will lower.

NOTE: When enabled, the HomeLink device automatically opens and closes when using Summon, and automatically opens as needed when using Smart Summon (if equipped). To automate HomeLink in other situations (such as normal driving), you must adjust the HomeLink device's main settings by touching the HomeLink icon at the top of the **Controls** screen (see [Smart Garage on page 71](#)).

The above settings, with the exception of HomeLink, apply only to Summon—not Smart Summon (if equipped) (see [Before Using Smart Summon on page 127](#)). You cannot customize Smart Summon's bumper clearance, distance, and side clearance. And when using Smart Summon, you must always hold down the button on the mobile app to keep Model Y moving. Also, Smart Summon operates with the mobile app only—not the key fob. All settings are retained until you manually change them.

Using Summon to Park and Retrieve your Vehicle

Follow these steps to use Summon to park your Model Y:

- Align Model Y within 12 meters of the parking space so Model Y can follow a straight path into or out of the space in either Drive or Reverse.
- From outside the vehicle, initiate the parking maneuver by touching **Summon** on the mobile app, then holding down the **Forward** or **Reverse** button.

NOTE: If the **Require Continuous Press** setting is **No**, you do not need to hold down the button, just press and release.



NOTE: You can also initiate the parking maneuver from inside the vehicle (see [Starting Summon Before Exiting the Vehicle on page 126](#)).

Summon shifts Model Y into Drive or Reverse (based on the direction you specified) and drives into or out of the parking space. When parking is complete, or if an obstacle is detected, Summon shifts Model Y into Park. Summon shifts Model Y into Park when:

- Model Y detects an obstacle in its driving path (within the **Bumper Clearance** setting that you specified).
- Summon has moved Model Y the maximum distance of 12 meters.
- You release the **Forward** or **Reverse** button (when Require Continuous Press is turned on).
- You press any button to manually stop Summon.

If you used Summon to park Model Y, you can then use Summon to return Model Y back to its original position (provided Model Y has remained in Park), or to the maximum **Summon Distance** that you have specified (whichever comes first). Simply specify the opposite direction on the mobile app and Summon moves Model Y along the original path, provided no obstructions have been introduced. If an obstacle is detected, Model Y attempts to avoid the obstacle while staying very close to its original path (Summon does not steer around obstacles).

NOTE: To use Summon to move Model Y multiple times in the same direction (not to exceed the maximum of 12 meters, cancel Summon and then restart the parking process using the same direction.

NOTE: Although Summon can move Model Y a short distance laterally to avoid an obstacle, it does not attempt to steer around an obstacle to return Model Y to its original driving path. Only Smart Summon (if equipped) can steer Model Y around objects.

NOTE: Summon requires that Model Y can detect an authenticated phone nearby.

WARNING: Model Y cannot detect obstacles that are located lower than the bumper, are very narrow, or are hanging from a ceiling (for example, bicycles). In addition, many unforeseen circumstances can impair Summon's ability to move in or out of a parking space and, as a result, Summon may not move Model Y appropriately. Therefore, you must continually monitor the vehicle's movement and its surroundings and remain prepared to stop Model Y at any time.

Starting Summon Before Exiting the Vehicle

To start a Summon parking sequence before exiting Model Y:

1. On the touchscreen, ensure that **Require Continuous Press** is disabled (touch **Controls** > **Autopilot** > **Customize Summon** > **Require Continuous Press**).
2. Close all doors and trunks.

3. With Model Y powered on and Park engaged, The touchscreen displays a popup screen.
4. On the touchscreen, choose the direction of travel.
5. Exit Model Y and close the driver's door.

Summon now moves Model Y according to the direction you specified on the touchscreen.

NOTE: To cancel the parking maneuver before exiting the vehicle, touch **Cancel** on the popup screen.

NOTE: If you do not choose a direction of travel on the touchscreen, Summon does not start a parking maneuver when you exit.

Stopping or Canceling Summon

Stop Model Y at any time while Summon is active by using the mobile app or by pressing any button on the key fob. Summon also cancels when:

- A door handle is engaged or a door is opened.
- You interact with the steering wheel, brake pedal, accelerator pedal, or shift.
- Model Y detects an obstacle.
- Summon has moved Model Y the maximum distance of approximately 12 meters.
- Your phone enters sleep mode or loses connectivity to Model Y.





This feature may be temporarily limited or inactive until it is enabled with a future software update for vehicles manufactured as of approximately mid-February 2024.

NOTE: Depending on market region, vehicle configuration, options purchased, and software version, your vehicle may not be equipped with Smart Summon, or the feature may not operate exactly as described.

Smart Summon is designed to allow you to move Model Y to your location (using your phone's GPS as a target destination) or to a location of your choice, maneuvering around and stopping for objects as necessary. Smart Summon works with the Tesla mobile app when your phone is located within approximately 65 meters of Model Y.

Smart Summon maneuvers Model Y out of parking spaces and around corners. This is useful for moving Model Y out of a tight parking spot, through puddles, or helping you retrieve your car while carrying packages. You must maintain a clear line of sight between you and Model Y and closely monitor the vehicle and its surroundings at all times.

 **CAUTION:** Smart Summon is designed and intended for use only on parking lots and driveways located on private property where the surrounding area is familiar and predictable. Do not use Smart Summon on public roads.

 **WARNING:** Smart Summon must only be used on paved surfaces.

 **WARNING:** Smart Summon is a BETA feature. You must continually monitor the vehicle and its surroundings and stay prepared to take immediate action at any time. It is the driver's responsibility to use Smart Summon safely, responsibly, and as intended. It is your responsibility to familiarize yourself with the limitations of Smart Summon (see [Limitations and Warnings on page 129](#)).

Before Using Smart Summon

- Download the latest version of the Tesla mobile app to your phone, and ensure your phone has cellular service and GPS enabled.
- Your phone must be connected to Model Y and located within approximately 65 meters.
- The vehicle's cameras must be fully calibrated (see [Drive to Calibrate Cameras on page 16](#)).
- You must have a clear line of sight to Model Y.
- Model Y must be in Park, not charging, and all doors and trunks must be closed.

 **CAUTION:** Ensure all cameras and sensors (if equipped) are clean. Dirty cameras and sensors, as well as environmental conditions such as rain and faded lane markings, can affect Autopilot performance.

Using Smart Summon

1. Open the Tesla mobile app, and press **Summon**.
2. Press the **Smart Summon** icon located in the center of the image of your Model Y. It may take several seconds for Smart Summon to start up.

NOTE: You can use Standby Mode to eliminate the delay that occurs when Smart Summon is starting up (see [Standby Mode on page 128](#)).

The mobile app displays a map with a blue circle, which represents the maximum proximity of 65 meters that you must maintain between your phone and Model Y. The blue dot on the map represents your location, and the red arrow represents the vehicle.

3. Position yourself anywhere within the blue circle where you have a clear line of sight to Model Y.
4. You can now operate Smart Summon using either of these modes:
 - **Come to Me** mode: Press and hold the **Come to Me** button. Model Y moves to your GPS location. As you move, Model Y follows you. When Model Y reaches you, it stops and shifts into park.
 - **Go to Target** mode: Touch the crosshair icon then drag the map to position the pin on a chosen destination. Press and hold the **Go to Target** button. Model Y moves to the destination. When reaching the location, Model Y stops and shifts into Park and the mobile app displays a message indicating that Summon has completed.

NOTE: To subsequently change the location, lift your finger, reposition the map, then press and hold **Go to Target** again.

To stop Model Y at any time, simply release the **Come to Me** or **Go to Target** button.



The map's crosshair icon toggles between **Go to Target** and **Come to Me** modes. When **Come to Me** mode is selected, the icon is blue.

NOTE: The map also has an icon that allows you to display/hide satellite imagery.

Immediately after initiating Smart Summon in either mode, hazard lights briefly flash, mirrors fold, and Model Y shifts into Drive or Reverse. Model Y then slowly moves to within 1 meter of you (**Come to Me**) or your chosen destination (**Go to Target**), navigating obstacles as needed. As Model Y moves, the corresponding red arrow on the map also moves to show the vehicle's location. As you move, the corresponding blue dot also moves to show your location.

In either mode, Model Y stops moving and shifts into park when:

- You release the button on the mobile app.



Smart Summon

- The maximum proximity between your phone and Model Y is exceeded (if moving the vehicle to a destination away from you, you may need to follow the car to maintain this distance).
- The driving path is blocked.
- Model Y has moved the maximum distance of 145 meters since the start of the Smart Summon session, or has moved 150 meters away from the location from which the vehicle was last driven manually.

NOTE: If Smart Summon moves Model Y forward 3 meters and then backwards 2 meters, this is considered 5 meters of travel.

NOTE: There is no need to look at the mobile app—just hold down the button while keeping your eye on Model Y and its driving path at all times, remaining ready to release the button to stop the vehicle if needed.

If equipped and Auto HomeLink is enabled for Summon (touch **Controls** > **Autopilot** > **Customize Summon** > **Use Auto HomeLink**), Smart Summon automatically opens a HomeLink device if you start the Smart Summon maneuver when Model Y is located inside a garage. The mobile app informs you that the door has opened.

 **WARNING:** When you release the button to stop Model Y, a slight delay occurs before the vehicle stops. Therefore, it is critical that you pay close attention to the vehicle's driving path at all times and proactively anticipate obstacles that the vehicle may be unable to detect.

 **WARNING:** Use extreme caution when using Smart Summon in environments where movement of obstacles can be unpredictable. For example, where people, children or animals are present.

 **WARNING:** Smart Summon may not stop for all objects (especially very low objects such as some curbs, or very high objects such as a shelf) and may not react to all oncoming or side traffic. Pay attention and be ready to stop Model Y at all times by releasing the button on the mobile app.

Standby Mode

To keep Model Y ready to Summon and reduce the time it takes to warm up, turn on Standby Mode. Touch **Controls** > **Autopilot** > **Standby Mode**. When Standby Mode is turned on, you can conserve Battery energy by disabling Standby Mode at these locations:

- **Exclude Home** - Disables Standby Mode at the location you set as Home in your Favorites list.
- **Exclude Work** - Disables Standby Mode at the location you set as Work in your Favorites list.
- **Exclude Favorites** - Disables Standby Mode at any location in your Favorites list.

NOTE: To conserve energy, Smart Summon automatically exits Standby mode from midnight to 6:00 am. During these hours, a delay occurs as Smart Summon starts up.

NOTE: Additional battery power may be consumed while Standby Mode is active.

NOTE: For details on how to designate a location as Home, Work, or Favorites, see [Home, Work, and Favorite Destinations](#) on page 161.

Stopping or Canceling Smart Summon

Smart Summon stops Model Y whenever you release the button on the mobile app. To resume the Smart Summon session, simply press the **Come to Me** or **Go to Target** button again.

 **WARNING:** Always anticipate when you need to stop Model Y. Depending on the quality of the connectivity between the phone and Model Y, there may be a slight delay between when you release the button and when the car stops.

Smart Summon cancels, and requires you to restart it, when:

- A door handle is engaged or a door is opened.
- You interact with the steering wheel, brake pedal, accelerator pedal, or shift.
- Model Y is blocked by an obstacle.
- Smart Summon has moved Model Y the maximum distance. To move further than this distance, you must shift Model Y into Drive or Reverse and then re-initiate a Smart Summon session.
- Your phone enters sleep mode or loses connectivity to Model Y.



This topic includes warnings, cautions, and limitations pertaining to the following Autopilot features.

- [Traffic-Aware Cruise Control on page 108](#)
- [Autosteer on page 109](#)
- [Navigate on Autopilot on page 131](#)
- [Autopark on page 131](#)
- [Summon on page 132](#)
- [Smart Summon on page 132](#)

NOTE: Depending on market region, vehicle configuration, options purchased, and software version, your vehicle may not be equipped with all features listed above, or a feature may not operate as described.

 **WARNING:** Read the following warnings and limitations carefully before using Autopilot. Failure to follow all warnings and instructions can result in property damage, serious injury, or death.

NOTE: Ensure all cameras are clean and free of obstructions before each drive and before using Autopilot features (see [Cleaning a Camera on page 192](#)). Dirty cameras and sensors (if equipped), as well as environmental conditions such as rain and faded lane markings, can affect Autopilot performance. If a camera is obstructed or blinded, Model Y displays a message on the touchscreen and Autopilot features may not be available. For more information on specific alerts, see [Troubleshooting Alerts on page 226](#).

Traffic-Aware Cruise Control

While using Traffic-Aware Cruise Control, **it is the driver's responsibility to stay alert, drive safely, and be in control of the vehicle at all times.** Always keep your eyes on the road when driving and be prepared to take corrective action as needed.

In addition, it is the driver's responsibility to cruise at a safe speed and maintain a safe following distance based on road conditions and applicable speed limits. Be aware of the following limitations while Traffic-Aware Cruise Control is active.

- There may be situations where the cruising speed may not change when the speed limit changes.
- Traffic-Aware Cruise Control does not adapt driving speed based on road and driving conditions. Do not use Traffic-Aware Cruise Control on winding roads with sharp curves, on icy or slippery road surfaces, or when weather conditions (such as heavy rain, snow, fog, etc.) make it inappropriate to drive at a consistent speed.
- Do not rely on Traffic-Aware Cruise Control to maintain an accurate or appropriate following distance.
- Traffic-Aware Cruise Control may be unable to provide adequate speed control because of limited braking capability and hills. It can also misjudge the distance from a vehicle ahead. Driving downhill can increase driving speed, causing Model Y to exceed your set speed (and potentially the road's speed limit).

- Traffic-Aware Cruise Control may occasionally cause Model Y to brake when not required or when you are not expecting it. This can be caused by closely following a vehicle ahead, detecting vehicles or objects in adjacent lanes (especially on curves), etc.
- Due to limitations inherent in the onboard GPS (Global Positioning System), you may experience situations in which Model Y slows down, especially near exits or off-ramps where a curve is detected and/or you are navigating to a destination and not following the route.
- In some cases (such as having insufficient data), Traffic-Aware Cruise Control may not automatically reduce the set speed on the highway interchange or off-ramp.
- Traffic-Aware Cruise Control may not detect all objects and, especially when cruising over 80 km/h, may not brake/decelerate when a vehicle or object is only partially in the driving lane or when a vehicle you are following moves out of your driving path and a stationary or slow-moving vehicle or object is in front of you.
- Traffic-Aware Cruise Control may react to vehicles or objects that either do not exist, or are not in your lane of travel, causing Model Y to slow down unnecessarily or inappropriately.

 **WARNING:** Traffic-Aware Cruise Control is particularly unlikely to operate as intended in the following types of situations:

- The road has sharp curves or significant changes in elevation.
- Road signs and signals are unclear, ambiguous, or poorly maintained.
- Visibility is poor (due to heavy rain, snow, hail, etc. or poorly lit roadways at night)
- You are driving in a tunnel or next to a highway divider that interferes with the view of the camera(s)
- Bright light (such as from oncoming headlights or direct sunlight) interferes with the view of the camera(s).

 **WARNING:** The list above does not represent an exhaustive list of situations that may interfere with proper operation of Traffic-Aware Cruise Control. Traffic-Aware Cruise Control can cancel unexpectedly at any time for unforeseen reasons. Always watch the road in front of you and stay prepared to take appropriate action. It is the driver's responsibility to be in control of Model Y at all times.

 **WARNING:** Traffic-Aware Cruise Control is designed for your driving comfort and convenience and is not a collision warning or avoidance system. Never depend on Traffic-Aware Cruise Control to adequately slow down Model Y. Always watch the road in front of you and be prepared to take corrective action at all times. Failure to do so can result in serious injury or death.



Limitations and Warnings

WARNING: Although Traffic-Aware Cruise Control is capable of detecting pedestrians and cyclists, never depend on Traffic-Aware Cruise Control to adequately slow Model Y down for them. Failure to do so can result in serious injury or death.

Autosteer

WARNING: Autosteer is a hands-on feature. Keep your hands on the steering wheel at all times, be mindful of road conditions and surrounding traffic, and always be prepared to take immediate action. Failure to follow these instructions could cause damage, serious injury or death.

WARNING: Autosteer is intended for use on controlled-access highways with a fully attentive driver. Do not use Autosteer in construction zones, or in areas where bicyclists or pedestrians may be present.

WARNING: Never depend on Autosteer to determine an appropriate driving path.

CAUTION: Autosteer and its associated functions are particularly unlikely to operate as intended when:

- Autosteer is unable to accurately determine lane markings. For example, lane markings are excessively worn, have visible previous markings, have been adjusted due to road construction, are changing quickly (lanes branching off, crossing over, or merging), objects or landscape features are casting strong shadows on the lane markings, or the road surface contains pavement seams or other high-contrast lines.
- Visibility is poor (heavy rain, snow, fog, etc.) or weather conditions are interfering with sensor operation.
- A camera(s) or sensor(s) is obstructed, covered, or damaged.
- Driving on hills.
- Approaching a toll booth.
- Driving on a road that has sharp curves or is excessively rough.
- Bright light (such as direct sunlight) is interfering with the view of the camera(s).
- The sensors (if equipped) are affected by other electrical equipment or devices that generate ultrasonic waves.
- A vehicle is detected in your blind spot when you engage the turn signal.
- Model Y is being driven very close to a vehicle in front of it, which is blocking the view of the camera(s).

WARNING: Many unforeseen circumstances can impair the operation of Autosteer. Always keep this in mind and remember that as a result, Autosteer may not steer Model Y appropriately. Always drive attentively and be prepared to take immediate action.

WARNING: Autosteer is not designed to, and will not, steer Model Y around objects partially in a driving lane and in some cases, may not stop for objects that are completely blocking the driving lane. Always watch the road in front of you and stay prepared to take immediate action. It is the driver's responsibility to be in control of Model Y at all times.

Auto Lane Change



CAUTION: When changing lanes using Auto Lane Change, It is the driver's responsibility to determine whether a lane change is safe and appropriate. Therefore, before initiating a lane change, always check blind spots, lane markings, and the surrounding roadway to confirm it is safe and appropriate to move into the target lane.

CAUTION: Be aware of the following limitations while using Auto Lane Change.





- Never depend on Auto Lane Change to determine an appropriate driving path. Drive attentively by watching the road and traffic ahead of you, checking the surrounding area, and monitoring the touchscreen for warnings. Always be prepared to take immediate action.
- Do not use Auto Lane Change on roads where traffic conditions are constantly changing and where bicycles and pedestrians are present.
- The performance of Auto Lane Change depends on the ability of the camera(s) to recognize lane markings.
- Do not use Auto Lane Change on winding roads with sharp curves, on icy or slippery roads, or when weather conditions (such as heavy rain, snow, fog, etc.) may be obstructing the view from the camera(s) or sensors (if equipped).
- Overtake Acceleration can cancel for many unforeseen reasons in addition to those listed above (for example, lack of GPS data). Stay alert and never depend on Overtake Acceleration to increase your driving speed.
- Overtake Acceleration increases your driving speed whenever the appropriate turn signal is engaged, and accelerates Model Y closer to the vehicle ahead. Although Traffic-Aware Cruise Control continues to maintain distance from the vehicle ahead, it is important to be aware that your selected following distance is reduced when Overtake Acceleration is active, particularly in cases where it may not be your intention to overtake the vehicle you are following.



Stop Light and Stop Sign Warning

-  **WARNING:** Stop Light and Stop Sign Warning requires on-board maps to know that a particular stop light or stop sign exists at a location. In some cases, map data is inaccurate or outdated and may not include all stop lights or stop signs. Therefore, Stop Light and Stop Sign Warning may not detect all stop lights and stop signs.
-  **WARNING:** The Stop Light and Stop Sign Warning feature does not apply the brakes or decelerate Model Y and may not detect all stop lights and stop signs. Stop Light and Stop Sign Warning is designed for guidance purposes only and is not a substitute for attentive driving and sound judgment. Keep your eyes on the road when driving and never depend on Stop Light and Stop Sign Warning to warn you of a stop light or stop sign.
-  **WARNING:** Stop Light and Stop Sign Warning is designed to warn you only when approaching a visible red stop sign, solid red or later portion of a yellow traffic light. It may not warn you of intersections with flashing lights and it does not warn you of yield signs or temporary stop and yield signs (such as those used in construction areas). Additionally, Stop Light and Stop Sign Warning does not warn you of approaching stop lights or stop signs when you are pressing the accelerator pedal or brake pedal (which disables Autosteer).

Navigate on Autopilot

-  **WARNING:** Never depend on Navigate on Autopilot to determine an appropriate lane at an off-ramp. Stay alert and perform visual checks to ensure that the driving lane is safe and appropriate.
-  **WARNING:** If you turn off **Require Lane Change Confirmation**, Navigate on Autopilot notifies you of upcoming lane changes and off-ramps, but it remains your responsibility to monitor the environment and maintain control of Model Y at all times. Lane changes can occur quickly and suddenly. Always keep your hands on the wheel and your eyes on the driving path in front of you.
-  **WARNING:** Navigate on Autopilot does not make driving autonomous. You must pay attention to the road, keep your hands on the steering wheel at all times, and remain aware of your navigation route.
-  **WARNING:** As is the case with normal driving, be extra careful around blind corners, interchanges, and on-ramps and off-ramps - obstacles can appear quickly and at any time.
-  **WARNING:** Navigate on Autopilot may not recognize or detect oncoming vehicles, stationary objects, and special-use lanes such as those used exclusively for bikes, carpools, emergency vehicles, etc. Remain alert at all times and be prepared to take immediate action. Failure to do so can cause damage, injury or death.

Autopark

-  **CAUTION:** Autopark's performance depends on the ability of the cameras and sensors (if equipped) to determine the vehicle's proximity to curbs, objects, and other vehicles. Be aware of the following warnings before and while using Autopark:
 - Do not use Autopark if anything, such as a ball hitch, bike rack, or trailer, is attached to the tow hitch. Autopark may not stop for hitches when parking between or in front of other vehicles.
 - Never depend on Autopark to find a parking space that is legal, suitable, and safe. Autopark may not always detect objects in the parking space. Always perform visual checks to confirm that a parking space is appropriate and safe.
 - When Autopark is actively steering Model Y, the steering wheel moves in accordance with Autopark's adjustments. Do not interfere with the movement of the steering wheel. Doing so cancels Autopark.
 - During the parking sequence, continually check your surroundings. Be prepared to apply the brakes to avoid vehicles, pedestrians, or objects.
 - When Autopark is active, monitor the touchscreen to ensure that you are aware of the instructions that Autopark is providing.

-  **CAUTION:**

Autopark is particularly unlikely to operate as intended in these situations:

 - The road is sloped. Autopark is designed to operate on flat roads only.
 - Visibility is poor (due to heavy rain, snow, fog, etc.).
 - The curb is constructed of material other than stone, or the curb cannot be detected.
 - The target parking space is directly adjacent to a wall or pillar (for example, the last parking space of a row in an underground parking structure).
 - One or more of the sensors (if equipped) or cameras is damaged, dirty, or obstructed (such as by mud, ice, or snow, or by a vehicle bra, excessive paint, or adhesive products such as wraps, stickers, rubber coating, etc.).
 - Weather conditions (heavy rain, snow, fog, or extremely hot or cold temperatures) are interfering with sensor (if equipped) operation.
 - The sensors (if equipped) are affected by other electrical equipment or electrical interference.



Limitations and Warnings

WARNING: Many unforeseen circumstances can impair Autopark's ability to park Model Y. Keep this in mind and remember that as a result, Autopark may not steer Model Y appropriately. Pay attention when parking Model Y and stay prepared to immediately take control.

Summon

CAUTION: Summon's performance depends on the ability of the cameras and sensors (if equipped) to determine the vehicle's proximity to objects, people, animals, and other vehicles. Summon is unlikely to operate as intended in the following types of situations:

- The driving path is sloped. Summon is designed to operate on flat roads only (up to 10% grade).
- A raised concrete edge is detected. Summon does not move Model Y over an edge that is higher than approximately 1 in (2.5 cm).
- One or more of the sensors (if equipped) or cameras is damaged, dirty, or obstructed (such as by mud, ice, or snow, or by a vehicle bra, excessive paint, or adhesive products such as wraps, stickers, rubber coating, etc.).
- Weather conditions (heavy rain, snow, fog, or extremely hot or cold temperatures) are interfering with sensor operation.
- The sensors (if equipped) are affected by other electrical equipment or devices that generate ultrasonic waves.
- Model Y is in Trailer Mode or an accessory is attached.

WARNING: The list above does not represent an exhaustive list of situations that may interfere with proper operation of Summon. It is the driver's responsibility to remain in control of Model Y at all times. Pay close attention whenever Summon is actively moving Model Y and stay prepared to take immediate action. Failure to do so can result in serious property damage, injury or death.

WARNING: Model Y cannot detect obstacles that are located lower than the bumper, are very narrow, or are hanging from a ceiling (for example, bicycles). In addition, many unforeseen circumstances can impair Summon's ability to move in or out of a parking space and, as a result, Summon may not move Model Y appropriately. Therefore, you must continually monitor the vehicle's movement and its surroundings and remain prepared to stop Model Y at any time.

Smart Summon

CAUTION: Smart Summon is a BETA feature. You must continually monitor the vehicle and its surroundings and stay prepared to take immediate action at any time. It is the driver's responsibility to use Smart Summon safely, responsibly, and as intended.

CAUTION: Smart Summon is designed and intended for use only on parking lots and driveways located on private property where the surrounding area is familiar and predictable. Do not use Smart Summon on public roads.

NOTE: Smart Summon is disabled if Model Y is in Valet mode (see [Valet Mode on page 97](#)).

CAUTION:





Smart Summon is unlikely to operate as intended in the following types of situations:

- GPS data is unavailable due to poor cellular coverage.
- The driving path is sloped. Smart Summon is designed to operate on flat roads only (up to 10% grade).
- A raised concrete edge is detected. Depending on the height of the concrete edge, Smart Summon may not move Model Y over it.
- One or more of the sensors (if equipped) or cameras is damaged, dirty, or obstructed (such as by mud, ice, or snow, or by a vehicle bra, excessive paint, or adhesive products such as wraps, stickers, rubber coating, etc.).
- Weather conditions (heavy rain, snow, fog, or extremely hot or cold temperatures) are interfering with sensor (if equipped) or camera operation.
- The sensors (if equipped) are affected by other electrical equipment or devices that generate ultrasonic waves.
- Model Y is in Trailer Mode or an accessory is attached

WARNING: The list above does not represent an exhaustive list of situations that may interfere with proper operation of Smart Summon. It is the driver's responsibility to remain in control of Model Y at all times. Pay close attention whenever Smart Summon is actively moving Model Y and stay prepared to take immediate action. Failure to do so can result in serious property damage, injury or death.

WARNING: Smart Summon must only be used on paved surfaces.



-  **WARNING:** Smart Summon may not stop for all objects (especially very low objects such as some curbs, or very high objects such as a shelf) and may not react to all traffic. Smart Summon does not recognize the direction of traffic, does not navigate around empty parking spaces, and may not anticipate crossing traffic.
-  **WARNING:** When using Smart Summon, you must maintain a clear line of sight between you and Model Y and stay prepared to stop the vehicle at any time by releasing the button on the mobile app.
-  **WARNING:** When you release the button to stop Model Y, a slight delay occurs before the vehicle stops. Therefore, it is critical that you pay close attention to the vehicle's driving path at all times and proactively anticipate obstacles that the vehicle may be unable to detect.
-  **WARNING:** Use extreme caution when using Smart Summon in environments where movement of obstacles can be unpredictable. For example, where people, children or animals are present.
-  **WARNING:** Smart Summon may not stop for all objects (especially very low objects such as some curbs, or very high objects such as a shelf) and may not react to all oncoming or side traffic. Pay attention and be ready to stop Model Y at all times by releasing the button on the mobile app.



Lane Assist

Model Y monitors the markers on the lane you are driving in as well as the surrounding areas for the presence of vehicles or other objects.

NOTE: For vehicles manufactured as of approximately mid-February 2024, Lane Assist does not show visualizations (colored lines on the touchscreen corresponding to detected objects) when Model Y is in motion, or the visualizations may not look exactly as described.

When an object is detected in your blind spot or near the side of Model Y (such as a vehicle, guard rail, etc.), the touchscreen displays colored lines radiating from the image of your vehicle. The location of the lines correspond to the location of the detected object. The color of the lines (white, yellow, orange, or red) represent the object's proximity to Model Y, with white being the farthest and red being the closest and requiring your immediate attention. These colored lines only display when driving between approximately 12 km/h and 140 km/h. When Autosteer is active, these colored lines also display if driving slower than 12 km/h. However, the colored lines do not display if Model Y is at a standstill (for example, in heavy traffic).



WARNING: Ensure all cameras are clean and free of obstructions before each drive and before using Autopilot features (see [Cleaning a Camera on page 192](#)). Dirty cameras and sensors (if equipped), as well as environmental conditions such as rain and faded lane markings, can affect Autopilot performance. If a camera is obstructed or blinded, Model Y displays a message on the touchscreen and Autopilot features may not be available. For more information on specific alerts, see [Troubleshooting Alerts on page 226](#).

WARNING: Lane Assist features are for guidance purposes only and are not intended to replace your own direct visual checks. Before changing lanes, always use side mirrors and perform the appropriate shoulder checks to visually determine if it is safe and appropriate to change lanes.

WARNING: Never depend on Lane Assist to inform you if you unintentionally drive outside of the driving lane, or to inform you that there is a vehicle beside you or in your blind spot. Several external factors can reduce the performance of Lane Assist (see [Limitations and Inaccuracies on page 135](#)). It is the driver's responsibility to stay alert and pay attention to the driving lane and other road users. Failure to do so can result in serious injury or death.

Steering Interventions

Lane Assist provides steering interventions if Model Y drifts into (or close to) an adjacent lane in which an object, such as a vehicle, is detected. In these situations, Model Y automatically steers to a safer position in the driving lane. This steering is applied only when Model Y is traveling between 40 and 145 km/h on major roads with clearly visible lane markings. When a steering intervention is applied, the touchscreen briefly displays a warning message.

Lane Departure Avoidance

Lane Departure Avoidance is designed to warn you if Model Y is drifting out of, or nears the edge of, your driving lane.

Lane Departure Avoidance operates when driving between 64 and 145 km/h on roads with clearly visible lane markings. You can choose if and how you want Lane Departure Warning to operate by touching **Controls > Autopilot > Lane Departure Avoidance** and selecting between these options:

- **Off:** You are not warned of lane departures or potential collisions with a vehicle in an adjacent lane.
- **Warning:** If a front wheel passes over a lane marking, the steering wheel vibrates.
- **Assist:** Corrective steering is applied to keep Model Y in a safe position if Model Y drifts into an adjacent lane or near the edge of the road.

When Lane Departure Avoidance is enabled and Traffic-Aware Cruise Control is active, if Model Y drifts out of the driving lane when the associated turn signal is off, Lane Assist also checks to see whether your hands are on the steering wheel. If hands are not detected, the touchscreen displays a series of alerts, similar to those that are used when driving with Autosteer. If hands are repeatedly not detected Model Y gradually slows down to 25 km/h below the detected speed limit, or below the set cruising speed, and the hazard lights start flashing.

NOTE: Lane Departure Avoidance does not warn you of lane departures, or provide steering interventions, if the associated turn signal is on, which indicates an intentional lane change.

WARNING: Lane Departure Avoidance is intended to help keep you safe, but it does not work in every situation and does not replace the need to remain attentive and in control.

 **WARNING:** Keep your hands on the steering wheel and drive attentively at all times.

 **WARNING:** Steering interventions are minimal and are not designed to move Model Y out of its driving lane. Do not rely on steering interventions to avoid side collisions.

Emergency Lane Departure Avoidance

Emergency Lane Departure Avoidance automatically applies steering to avoid a potential collision in situations where:

- Model Y is departing a lane and may collide with a vehicle traveling in the same direction in the adjacent lane (regardless of the status of the turn signal).
- Model Y is departing a lane into an oncoming lane, the turn signal is off, and an oncoming vehicle is detected.
- Model Y is departing the road and the turn signal is off (for example, very close to the edge of the road and a collision may occur).

Emergency Lane Departure Avoidance is automatically enabled at the beginning of every drive. You can turn it off for the current drive only by touching **Controls > Autopilot > Emergency Lane Departure Avoidance**.

When Emergency Lane Departure Avoidance applies steering, a chime sounds and the touchscreen displays a warning and highlights the lane marking in red.

Emergency Lane Departure Avoidance operates when Model Y is traveling between 64 and 145 km/h on a road with clearly visible lane markings, curbs, etc.

 **WARNING:** Emergency Lane Departure Avoidance is not a substitute for attentive driving and sound judgment. Keep your eyes on the road when driving and never depend on Emergency Lane Departure Avoidance to prevent a collision. Several factors can reduce or impair performance. Depending on Emergency Lane Departure Avoidance to prevent a potential collision can result in serious injury or death.

Blind Spot Assist

Automatic Blind Spot Camera

You can turn it on/off by touching **Controls > Autopilot > Automatic Blind Spot Camera** on the touchscreen.

Once enabled, when the turn signal is engaged, the touchscreen displays the image from the corresponding side repeater camera. When a vehicle is detected in your blind spot in an adjacent lane, a vertical red bar appears on the image to warn you. For example, when the left turn signal is engaged and a vehicle is detected, a vertical red bar appears on the left side of the image. You can move the image to a different location on the touchscreen. To do so, touch and

drag the image to the new location (valid locations are indicated by shaded areas that display when you touch and hold the image).

 **WARNING:** Automatic Blind Spot Camera does not eliminate the need to drive attentively and manually perform shoulder checks when changing lanes.

Blind Spot Collision Warning Chime

If you want a chime to sound when a vehicle is in your blind spot and a possible collision is detected, touch **Controls > Safety > Blind Spot Collision Warning Chime**.

 **WARNING:** Blind Spot Camera does not eliminate the need to drive attentively and manually perform shoulder checks when changing lanes.

 **WARNING:** Blind Spot Collision Warning Chime cannot detect every collision. It is the driver's responsibility to remain alert and perform the appropriate shoulder checks when changing lanes.

Limitations and Inaccuracies

Lane Assist features cannot always detect lane markings and you may experience unnecessary or invalid warnings when:

- Visibility is poor and lane markings are not clearly visible (due to heavy rain, snow, fog, etc.).
- Bright light (such as from oncoming headlights or direct sunlight) is interfering with the view of the camera(s).
- A vehicle in front of Model Y is blocking the view of the camera(s).
- The windshield is obstructing the view of the camera(s) (fogged over, dirty, covered by a sticker, etc.).
- Lane markings are excessively worn, have visible previous markings, have been adjusted due to road construction, or are changing quickly (for example, lanes branching off, crossing over, or merging).
- The road is narrow or winding.
- Objects or landscape features are casting strong shadows on lane markers.

Lane Assist may not provide warnings, or may apply inappropriate warnings, when:

- One or more of the sensors (if equipped), or cameras is damaged, dirty, or obstructed (by mud, ice, or snow, or by a vehicle bra, excessive paint, or adhesive products such as wraps, stickers, rubber coatings, etc.).
- Weather conditions (heavy rain, snow, fog, or extremely hot or cold temperatures) are interfering with sensor operation.
- The sensors (if equipped) are affected by other electrical equipment or devices that generate ultrasonic waves.



Lane Assist

- An object that is mounted to Model Y is interfering with and/or obstructing a sensor (such as a bike rack or a bumper sticker).

In addition, Lane Assist may not steer Model Y away from an adjacent vehicle, or may apply unnecessary or inappropriate steering, in these situations:

- You are driving Model Y on sharp corners or on a curve at a relatively high speed.
- Bright light (such as from oncoming headlights or direct sunlight) is interfering with the view of the camera(s).
- You are drifting into another lane but an object (such as a vehicle) is not present.
- A vehicle in another lane cuts in front of you or drifts into your driving lane.
- Model Y is not traveling within the speeds at which the Lane Assist feature is designed to operate.
- One or more of the sensors (if equipped) is damaged, dirty, or obstructed (such as by mud, ice, or snow, or by a vehicle bra, excessive paint, or adhesive products such as wraps, stickers, rubber coating, etc.).
- Weather conditions (heavy rain, snow, fog, or extremely hot or cold temperatures) are interfering with sensor operation.
- The sensors (if equipped) are affected by other electrical equipment or devices that generate ultrasonic waves.
- An object mounted to Model Y (such as a bike rack or a bumper sticker) is interfering with or obstructing a sensor.
- Visibility is poor and lane markings are not clearly visible (due to heavy rain, snow, fog, etc.).
- Lane markings are excessively worn, have visible previous markings, have been adjusted due to road construction or are changing quickly (for example, lanes branching off, crossing over, or merging).



CAUTION: Driver assistance features are automatically disabled when Track Mode is On. It is the driver's responsibility to drive safely and be in control of the vehicle at all times, including on track. Driver Assistance features automatically re-enable when Track Mode is turned Off.



WARNING: The lists above do not represent every possible situation that may interfere with Lane Assist features. There are many reasons why Lane Assist may not operate as intended. To avoid a collision, stay alert and always pay attention to the road so you can anticipate the need to take corrective action as early as possible.



The following collision avoidance features are designed to increase the safety of you and your passengers:

- **Forward Collision Warning** - provides visual and audible warnings in situations when Model Y detects that there is a high risk of a frontal collision (see [Forward Collision Warning on page 137](#)).
- **Automatic Emergency Braking** - automatically applies braking to reduce the impact of a collision (see [Automatic Emergency Braking on page 138](#)).
- **Obstacle-Aware Acceleration** - reduces acceleration if Model Y detects an object in its immediate driving path (see [Obstacle-Aware Acceleration on page 138](#)).

CAUTION: Ensure all cameras are clean and free of obstructions before each drive and before using Autopilot features (see [Cleaning a Camera on page 192](#)). Dirty cameras and sensors (if equipped), as well as environmental conditions such as rain and faded lane markings, can affect Autopilot performance. If a camera is obstructed or blinded, Model Y displays a message on the touchscreen and Autopilot features may not be available. For more information on specific alerts, see [Troubleshooting Alerts on page 226](#).

WARNING: Forward Collision Warning is for guidance purposes only and is not a substitute for attentive driving and sound judgment. Keep your eyes on the road when driving and never depend on Forward Collision Warning to warn you of a potential collision. Several factors can reduce or impair performance, causing either unnecessary, invalid, inaccurate, or missed warnings. Depending on Forward Collision Warning to warn you of a potential collision can result in serious injury or death.

WARNING: Automatic Emergency Braking is not designed to prevent all collisions. In certain situations, it can minimize the impact of a collision by attempting to reduce your driving speed. Depending on Automatic Emergency Braking to avoid a collision can result in serious injury or death.

WARNING: Obstacle-Aware Acceleration is not designed to prevent a collision. In certain situations, it can minimize the impact of a collision. Depending on Obstacle-Aware Acceleration to avoid a collision can result in serious injury or death.

Forward Collision Warning

Model Y monitors the area in front of it for the presence of an object such as a vehicle, motorcycle, bicycle, or pedestrian. If a collision is considered likely unless you take immediate corrective action, Forward Collision Warning is designed to sound a chime and highlight the vehicle in front of you in red on the touchscreen. If this happens, **TAKE IMMEDIATE CORRECTIVE ACTION!**

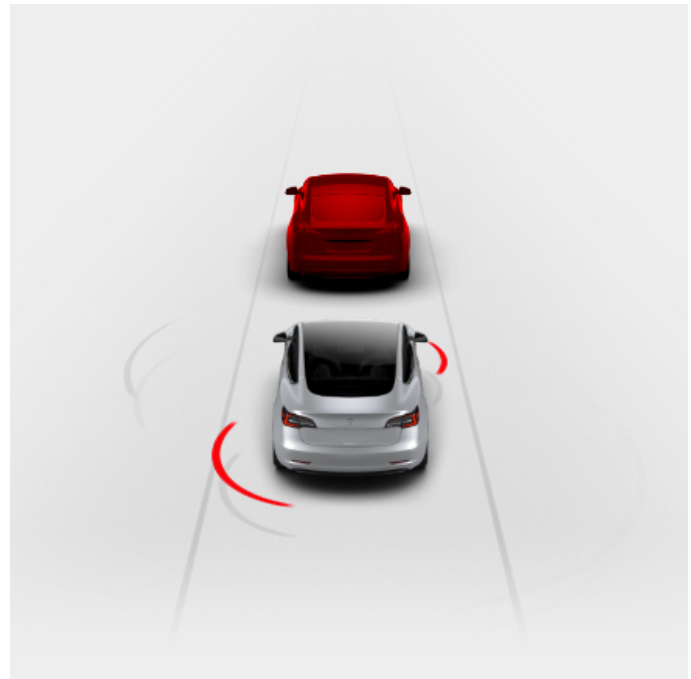

Visual and audible warnings cancel automatically when the risk of a collision has been reduced (for example, you have decelerated or stopped Model Y, or the object in front of your vehicle has moved out of your driving path).

If immediate action is not taken when Model Y issues a Forward Collision Warning, Automatic Emergency Braking (if enabled) may automatically apply the brakes if a collision is considered imminent (see [Automatic Emergency Braking on page 138](#)).

By default, Forward Collision Warning is turned on. To turn off or adjust sensitivity, touch **Controls > Autopilot > Forward Collision Warning**. Instead of the default warning level of **Medium**, you can turn the warning **Off**, or you can choose to be warned **Late** or **Early**.

NOTE: Your chosen setting is retained until you manually change it.

WARNING: The camera(s) and sensors (if equipped) associated with Forward Collision Warning are designed to monitor an approximate area of up to 160 meters in your driving path. The area being monitored by Forward Collision Warning can be adversely affected by road and weather conditions. Use appropriate caution when driving.

WARNING: Forward Collision Warning is designed only to provide visual and audible alerts. It does not attempt to apply the brakes or decelerate Model Y. When seeing and/or hearing a warning, it is the driver's responsibility to take immediate corrective action.

WARNING: Forward Collision Warning may provide a warning in situations where the likelihood of collision may not exist. Stay alert and always pay attention to the area in front of Model Y so you can anticipate whether any action is required.



Collision Avoidance Assist

Forward Collision Warning operates only when driving between approximately 5 km/h and 200 km/h.

WARNING: Forward Collision Warning does not provide a warning when the driver is already applying the brake.

Automatic Emergency Braking

Model Y is designed to determine the distance from detected objects. When a collision is considered unavoidable, Automatic Emergency Braking is designed to apply the brakes to reduce the vehicle's speed and therefore, the severity of the impact. The amount of speed that is reduced depends on many factors, including driving speed and environment.

When Automatic Emergency Braking applies the brakes, the touchscreen displays a visual warning and sounds a chime. You may also notice abrupt downward movement of the brake pedal. The brake lights turn on to alert other road users that you are slowing down.



Emergency braking in progress

Automatic Emergency Braking operates only when driving between approximately 5 km/h and 200 km/h.

Automatic Emergency Braking does not apply the brakes, or stops applying the brakes, when:

- You turn the steering wheel sharply.
- You press and release the brake pedal while Automatic Emergency Braking is applying the brakes.
- You accelerate hard while Automatic Emergency Braking is applying the brakes.
- The vehicle, motorcycle, bicycle, or pedestrian is no longer detected in the front or rear of the vehicle.

Automatic Emergency Braking is always enabled when you start Model Y. To disable for your current drive, shift into Park and touch **Controls > Autopilot > Automatic Emergency Braking**. Even if you disable Automatic Emergency Braking, your vehicle may still apply the brakes after detecting an initial collision to reduce further impact (see [Multi-Collision Braking on page 138](#)). When disabled, the touchscreen displays a visual message.



Automatic Emergency Braking is disabled

WARNING: It is strongly recommended that you do not disable Automatic Emergency Braking. If you disable it, Model Y does not automatically apply the brakes in situations where a collision is considered likely.

NOTE: Automatic Emergency Braking is designed to reduce the impact of frontal collisions only.

NOTE: Automatic Emergency Braking is designed to reduce the impact of frontal and reverse collisions with limited functionality while in Reverse.

In the event Automatic Emergency Braking is unavailable, the touchscreen displays a visual warning.



Automatic Emergency Braking is not available

WARNING: Automatic Emergency Braking is designed to reduce the severity of an impact. It is not designed to avoid a collision.

WARNING: Several factors can affect the performance of Automatic Emergency Braking, causing either no braking or inappropriate or untimely braking, such as when a vehicle is partially in the path of travel or there is road debris. It is the driver's responsibility to drive safely and remain in control of the vehicle at all times. Never depend on Automatic Emergency Braking to avoid or reduce the impact of a collision.

WARNING: Automatic Emergency Braking is not a substitute for maintaining a safe traveling distance between you and the vehicle in front of you.

WARNING: The brake pedal moves downward abruptly during automatic braking events. Always ensure that the brake pedal can move freely. Do not place material under or on top of the driver's floor mat (including an additional mat) and always ensure that the driver's floor mat is properly secured. Failure to do so can impede the ability of the brake pedal to move freely.

Multi-Collision Braking

In addition to Automatic Emergency Braking, Model Y may apply the brakes to prevent or mitigate a subsequent impact after an initial collision if airbag deployment is detected. The brakes may be applied regardless of driving speed.

Obstacle-Aware Acceleration

Obstacle-Aware Acceleration is designed to reduce the impact of a collision by reducing motor torque and in some cases applying the brakes, if Model Y detects an object in its driving path. The touchscreen displays a visual warning and sounds a chime when the brakes are automatically applied. For example, Model Y, while parked in front of a closed garage door with Drive engaged, detects that you have pressed hard on the accelerator pedal. Although Model Y still accelerates and hits the garage door, the reduced torque may result in less damage.





Obstacle-Aware Acceleration is designed to operate only when all of these conditions are simultaneously met:

- Drive or Reverse is engaged.
- Model Y is stopped or traveling less than 16 km/h.



- Model Y detects an object in its immediate driving path.

To disable Obstacle-Aware Acceleration, touch **Controls** > **Autopilot** > **Obstacle-Aware Acceleration**.

-  **WARNING:** Obstacle-Aware Acceleration is designed to reduce the severity of an impact. It is not designed to avoid a collision.
-  **WARNING:** Obstacle-Aware Acceleration may not limit torque in all situations, such as performing a sharp turn into a parking space. Several factors, including environmental conditions, distance from an obstacle, and a driver's actions, can limit, delay, or inhibit Obstacle-Aware Acceleration.
-  **WARNING:** Do not rely on Obstacle-Aware Acceleration to control acceleration or to avoid, or limit, the severity of a collision, and do not attempt to test Obstacle-Aware Acceleration. Doing so can result in serious property damage, injury, or death.
-  **WARNING:** Several factors can affect the performance of Obstacle-Aware Acceleration, causing an inappropriate or untimely reduction in motor torque. It is the driver's responsibility to drive safely and remain in control of Model Y at all times.

-  **WARNING:** The limitations previously described do not represent an exhaustive list of situations that may interfere with proper operation of Collision Avoidance Assist features. These features may fail to provide their intended function for many other reasons. It is the driver's responsibility to avoid collisions by staying alert, paying attention, and taking corrective action as early as possible.

Limitations and Inaccuracies

Collision Avoidance features cannot always detect all objects, vehicles, bikes, or pedestrians, and you may experience unnecessary, inaccurate, invalid, or missed warnings for many reasons, particularly if:

- The road has sharp curves.
- Visibility is poor (due to heavy rain, snow, fog, etc.).
- Bright light (such as from oncoming headlights or direct sunlight) is interfering with the view of the camera(s).
- A camera or sensor is obstructed (dirty, covered, fogged over, covered by a sticker, etc.).
- One or more of the sensors (if equipped) is damaged, dirty, or obstructed (such as by mud, ice, or snow, or by a vehicle bra, excessive paint, or adhesive products such as wraps, stickers, rubber coating, etc.).
- Weather conditions (heavy rain, snow, fog, or extremely hot or cold temperatures) are interfering with sensor operation.
- The sensors (if equipped) are affected by other electrical equipment or devices that generate ultrasonic waves.

-  **CAUTION:** If a fault occurs with a Collision Avoidance Assist feature, Model Y displays an alert. Contact Tesla Service.

-  **CAUTION:** Driver assistance features are automatically disabled when Track Mode is On. It is the driver's responsibility to drive safely and be in control of the vehicle at all times, including on track. Driver Assistance features automatically re-enable when Track Mode is turned Off.

How Speed Assist Works

Model Y displays a speed limit on the touchscreen and you can choose if and how you are warned when you exceed the speed limit. In addition, a blue outline may appear around the speed limit icon to notify that you are above the speed limit.

Instead of using the detected speed limit, you can base warnings on an arbitrary speed limit that you enter manually.

NOTE: When using Traffic-Aware Cruise Control, you can touch this speed limit sign to change your set cruising speed to the detected speed limit (including any offsets that you have set).

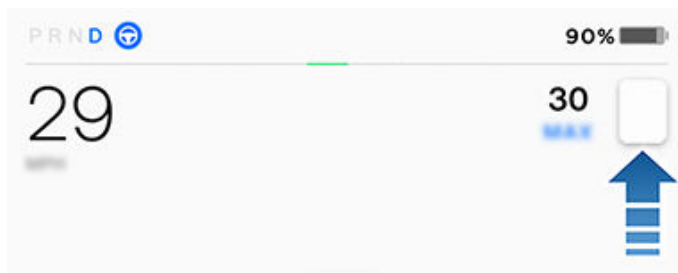

In situations where Model Y is unable to determine a speed limit, or if Speed Assist is uncertain that an acquired speed limit is accurate, the touchscreen may not display a speed limit sign and warnings do not take effect.

NOTE: Speed limit warnings go away after ten seconds, or when Model Y slows down below the specified limit.

WARNING: Do not rely on Speed Assist to determine the appropriate speed limit or driving speed. Always drive at a safe speed based on traffic and road conditions.

Controlling Speed Assist

To adjust the Speed Limit Warning setting, touch **Controls** > **Autopilot** > **Speed Limit Warning**, then choose one of these options:

- **Off** - Speed limit warnings do not display and chimes are not sounded.
- **Display** - Speed limit signs display on the touchscreen and the sign increases in size when you exceed the determined limit.
- **Chime** - In addition to the visual display, a chime is sounded when you exceed the determined speed limit.

You can also specify how the speed limit is determined:

- **Relative** - You can set a speed limit offset (+ or -) if you want to be alerted only when you exceed the offset speed limit by a specified amount. For example, you can increase the offset to +10 km/h if you only want to be warned when you exceed the speed limit by 10 km/h.
- **Absolute** - Manually specify any speed limit between 30 and 240 km/h.

NOTE: Speed Assist is not always accurate. In some situations, the location of a road can be miscalculated and Speed Assist can display a speed for a directly adjacent road that may have a different speed limit. For example, Speed Assist can assume Model Y is on a controlled-access highway when it is actually on a nearby surface street, and vice versa.

NOTE: Your chosen setting is retained until you manually change it.

Live Average Speed

When driving through an average speed zone, Model Y displays your average speed on the touchscreen below the detected speed limit.

The touchscreen also shows the distance remaining in the average speed zone.

NOTE: Premium Connectivity required. To enable this feature, enable online routing by touching **Controls** > **Navigation** > **Online Routing** (see [Maps and Navigation on page 159](#)).

Limitations and Inaccuracies

Speed Assist may not be fully functional or may provide inaccurate information in these situations:

- Visibility is poor and speed limit signs are not clearly visible (due to heavy rain, snow, fog, etc.).
- Bright light (such as from oncoming headlights or direct sunlight) is interfering with the view of the camera(s).
- Model Y is being driven very close to a vehicle in front of it which is blocking the view of the camera(s).
- The windshield is obstructing the view of the camera(s) (fogged over, dirty, covered by a sticker, etc.).
- Speed limit signs are concealed by objects.
- The speed limits stored in the map database are incorrect or outdated.
- Model Y is being driven in an area where GPS or map data is not available or where speed limit signs can not be detected.
- Traffic signs that do not conform to standard recognizable formats, such as digital or temporary speed signs.
- A road or a speed limit has recently changed.

WARNING: The list above does not represent an exhaustive list of situations that may interfere with proper operation of Speed Assist. Speed Assist may fail to provide warnings for many other reasons.



Your Model Y may be equipped with a cabin camera located above the rear view mirror.



NOTE: Keep the camera lens clean and free of obstructions. Remove any buildup of dirt or dust by occasionally wiping the camera lens with a clean cloth.

CAUTION: Do not use chemical-based or abrasive cleaners. Doing so can damage the surface of the camera lens.

The cabin camera can determine driver inattentiveness and provide you with audible alerts, to remind you to keep your eyes on the road when Autopilot is engaged.

By default, images and video from the camera do not leave the vehicle itself and are not transmitted to anyone, including Tesla, unless you enable data sharing. If you enable data sharing and a safety critical event occurs (such as a collision), Model Y shares short cabin camera video clips with Tesla to help us develop future safety enhancements and continuously improve the intelligence of features that rely on the cabin camera. Data may also be shared if diagnostics are required on cabin camera functionality. Cabin camera does not perform facial recognition or any other method of identity verification. To protect your privacy, cabin camera data is not associated with your vehicle identification number.

To adjust your data sharing preferences touch **Controls > Software > Data Sharing > Allow Cabin Camera Analytics**. You can change your data sharing settings at any time. To view features currently enabled that use cabin camera, touch **Controls > Software > Cabin Camera**.





About the Security System

If Model Y does not detect an authenticated phone or key and a locked door or trunk is opened, an alarm sounds. The headlights and turn signals also flash. To deactivate the alarm, press any button on the mobile app or tap your key card or key fob against the card reader located approximately one third the way up of the driver's side door pillar.

To manually enable or disable the alarm system, touch **Controls > Safety > Security Alarm**. When enabled, Model Y activates its alarm one minute after you exit, the doors lock, and a recognized key is no longer detected.

A battery-backed siren (if equipped) sounds in situations where a locked door or trunk is opened and Model Y does not detect a key nearby. If you also want this siren to sound in situations where the vehicle detects motion inside the cabin, enable **Tilt/Intrusion** (see [Tilt/Intrusion \(if equipped\) on page 142](#)).

NOTE: If Model Y is in Sentry Mode (see [How to Use Sentry Mode \(With a USB Flash Drive\) on page 146](#)), the **Security Alarm** setting is not available.

Tilt/Intrusion (if equipped)

Depending on configuration, market region, and date of manufacture, your vehicle may not be equipped with this feature.

The **Security Alarm** must be on to enable **Tilt/Intrusion**.

Tilt/Intrusion sounds the alarm in your vehicle if Model Y detects motion inside the cabin, or is moved or tilted (for example, with a tow truck or jack). To enable, touch **Controls > Safety > Tilt/Intrusion**.

The intrusion sensor automatically disables in situations where the climate control system is operating when you leave your vehicle. To override, you can manually turn the Tilt/Intrusion Sensor on again after choosing Keep Climate On, Dog, or Camp Mode.

The tilt/intrusion sensor automatically re-enables at the start of every drive cycle.

NOTE: The **Tilt/Intrusion** alarm must be turned off to use **Cabin Overheat Protection** (see [Cabin Overheat Protection on page 152](#)).

NOTE: If you plan to leave something that moves inside your locked vehicle, remember to turn off **Tilt/Intrusion**. If this setting is on, any motion detected inside Model Y activates the intrusion alarm.

NOTE: If Model Y is in Sentry Mode (see [How to Use Sentry Mode \(With a USB Flash Drive\) on page 146](#)), the **Tilt/Intrusion** setting is not available.

Parental Controls

Parental controls enable you to limit the capabilities of Model Y and ensure that safety settings are enabled and cannot be changed.

NOTE: You can also access parental controls from the Tesla mobile app (version 4.34.5 or higher required).

NOTE: You cannot enable Parental Controls if **Speed Limit Mode** is enabled.

When you enable **Require Safety Features**, Model Y enables or configures these vehicle settings:

NOTE: Depending on market region, vehicle configuration, options purchased, and software version, your vehicle may not be equipped with the listed features.

- **Automatic Emergency Braking**
- **Obstacle-Aware Acceleration**
- **Automatic Blind Spot Camera**
- **Blind Spot Collision Warning Chime**
- **Automatic 911 Call**
- **Allow Mobile Access**
- **Park Assist Chimes**
- **Lane Departure Avoidance:** Set to **Assist**.
- **Speed Limit Warning:** Set to **Chime**.
- **Forward Collision Warning:** Set to **Early**.

If you want to enable parental controls:

1. With your vehicle in Park, touch **Controls > Safety > Parental Controls** on the touchscreen.
2. Enable or configure the parental controls you want to use:
 - **Limit Speed:** Caps the speed at which Model Y can drive.
 - **Reduce Acceleration:** Limits the vehicle **Acceleration to Chill**.
 - **Require Safety Features:** Enables various safety features in the vehicle (if equipped). Drivers cannot change these settings while parental controls are active.
 - **Send Curfew Notifications:** Turns on curfew notifications from 11 PM to 4 AM. When someone shifts the vehicle to Drive after the start of curfew, a notification is sent through the Tesla mobile app to all phone keys paired with the vehicle, notifying users that Model Y is in use.
3. Touch **Confirm**.
4. Enter a PIN.

NOTE: Drivers must re-enter the PIN from **Parental Controls** to disable the restrictions. Touch **Driver Profile > Parental Controls** to re-enter the PIN.



PIN to Drive

For an added layer of security, prevent Model Y from being driven until a 4-digit PIN (Personal Identification Number) is entered. To enable this setting, touch **Controls > Safety > PIN to Drive** and follow the on-screen prompts to create a driving PIN.

When enabled, in addition to entering the 4-digit driving PIN to drive, you must also use it to enter Valet mode for the first time and create the 4-digit valet PIN to enter and exit Valet mode. In Valet mode, Model Y can be driven without the need for the valet to enter a driving PIN. The **PIN to Drive** setting is disabled whenever Valet mode is active.

If you forget your driving PIN, touch the link to enter your Tesla login credentials on the PIN to Drive popup, then follow the instructions on the touchscreen.

NOTE: In the unlikely event that your touchscreen is unresponsive, you may be unable to enter the PIN. In this case, first try to restart the touchscreen (see [Restarting the Touchscreen on page 7](#)). If the touchscreen is still unresponsive, you can still bypass PIN to Drive by turning on Keyless Driving in the Tesla mobile app.

Glovebox PIN

Protect the contents in your glovebox with a 4-digit PIN (not related to PIN to Drive). To enable, touch **Controls > Safety > Glovebox PIN** and follow the directions on the touchscreen. When enabled, you are prompted to enter the PIN to open the glovebox. Select the toggle to disable and then enter the PIN to remove this added security protection.

If you forget your glovebox PIN, reset it by entering your Tesla login credentials, then follow the directions on the touchscreen.

NOTE: Using a **Glovebox PIN** allows the glovebox to be opened even when Model Y is in Valet mode.

Speed Limit Mode

Speed Limit Mode allows you to limit acceleration and maximum driving speed to a chosen value between 80 and 193 km/h. The first time you use this feature, you must create a 4-digit PIN that you must use to enable and disable Speed Limit Mode. When enabled and the driving speed approaches within approximately 5 km/h of the maximum speed, a chime sounds, the touchscreen displays a message, and Model Y sends a notification to the mobile app. You can also touch **Security > Speed Limit Mode** to enable from the Tesla mobile app. To enable Speed Limit Mode:

1. Ensure Model Y is in Park.
2. Touch **Controls > Safety > Speed Limit Mode** on the touchscreen.
3. Select the maximum driving speed.
4. Drag the slider to the **On** position.

5. Enter the 4-digit PIN that you want to use to enable and disable Speed Limit Mode.

NOTE: If you forget the PIN, you can disable Speed Limit Mode by entering login credentials for your Tesla account.

NOTE: **Off-Road Assist** cannot be used if Speed Limit Mode is already enabled.

NOTE: While Speed Limit Mode is enabled, the acceleration setting automatically sets to **Chill**.

 **WARNING:** Driving downhill can increase driving speed and cause Model Y to exceed your chosen maximum speed.

 **WARNING:** Speed Limit Mode is not a replacement for good judgment, driver training, and the need to closely monitor speed limits and driving conditions. Accidents occur at any speed and it is your responsibility to drive safely.

Clear Browser Data

You can clear your vehicle's browser data (like you would on a computer or smartphone) by navigating to **Controls > Service > Clear Browser Data**. This is useful for many situations, such as erasing settings or searches from another driver.

Check the boxes on the touchscreen popup to exclude bookmarks and/or history for your convenience.



NOTE: Depending on market region, vehicle configuration, options purchased, and software version, your vehicle may not be equipped with Dashcam or the features may not operate exactly as described. **It is your sole responsibility to consult and comply with all local regulations and property restrictions regarding the use of cameras.**

Dashcam records video footage of your vehicle's surroundings while driving. Use Dashcam to record driving incidents or other notable events, like you would for an external dashcam on other vehicles.

The Dashcam icon is located in the app launcher. You can add the Dashcam app to the bottom bar for easy access (see [Customizing My Apps on page 6](#)). When Model Y is in Park, touching the Dashcam icon displays the Viewer (see [Viewing Video Recordings on page 148](#)).



To protect your privacy, video recordings are saved locally to a formatted USB flash drive's onboard memory. Recordings are not sent to Tesla. Model Y does not record videos when Dashcam is **Off**.

How to Use Dashcam

1. Format a USB flash drive. Dashcam requires a properly formatted USB drive inserted in your vehicle's USB port to store and retrieve footage. Vehicles manufactured beginning approximately 2020 are equipped with a pre-formatted USB flash drive in the glove box. There are two ways to format the flash drive if needed:
 - Format the flash drive with Model Y. Insert the flash drive into the USB port and navigate to **Controls > Safety > Format USB Drive**.
 - Format the flash drive on a computer. See [USB Drive Requirements for Recording Videos on page 148](#) for more information.
2. Insert the USB flash drive into your vehicle's USB port, preferably the one in the glovebox (if equipped).

NOTE: For some vehicles manufactured after approximately November 1, 2021, the center console USB ports may only support charging devices. Use the USB port inside the glove box for all other functions.
3. Enable Dashcam by touching **Controls > Dashcam**. Dashcam allows you to choose how and when footage is saved. You can choose between:
 - **Auto:** Dashcam automatically saves a recording to the USB drive when Model Y detects a safety-critical event, such as a collision or airbag deployment. When **Auto** is selected, detection can vary and is subject to your vehicle's power, sleep, and Autopilot state.

NOTE: Several factors determine whether Dashcam automatically saves a recording of a safety-critical event (for example, amount of force, whether or not airbags deploy, etc.). Do not rely on Dashcam to automatically record all safety-critical events.

- **Manual:** You must manually touch the Dashcam icon to save a recording of the most recent ten minutes of footage.
 - **On Honk:** When you press the horn, Dashcam saves a recording of the most recent ten minutes of footage. You can enable this along with **Auto** or **Manual** simultaneously.
4. Once enabled, the Dashcam icon indicates when footage is saved. You can also view the status of the Dashcam icon in **Controls**:



The icon changes to show the status of Dashcam:



RECORDING: Dashcam is recording. To save video footage, touch the icon. To pause recording, press and hold the icon.



AVAILABLE: Dashcam is available but not actively recording. Touch the dashcam icon to start recording footage.



PAUSED: Dashcam is paused. To resume recording, touch the icon. To avoid losing video footage, pause Dashcam before removing the flash drive.



BUSY: Dashcam is in the process of loading, saving, or overwriting footage. While dashcam is busy, footage is not being captured and recorded.



SAVED: Footage is saved. You can also save Dashcam clips by touching the Dashcam icon in the app launcher while Driving.

5. When your desired footage is saved, view the clips on the touchscreen or a computer:
 - Touchscreen: Ensure Model Y is in Park and touch the Dashcam icon in the app launcher. Videos are organized by timestamp. See [Viewing Video Recordings on page 148](#) for more information.
 - Computer: Insert the USB flash drive into a computer and navigate to the TeslaCam folder. Videos are organized by timestamp. See [Viewing Video Recordings on page 148](#) for more information.

6. To turn Dashcam off, navigate to **Controls > Dash cam > Off**. If set to **Auto**, **Manual**, or **On Honk**, Dashcam automatically enables (but may not be actively saving footage, depending on your preferences) every time you drive.



Sentry Mode

NOTE: Depending on market region, vehicle configuration, options purchased, and software version, your vehicle may not be equipped with Sentry Mode or the features may not operate exactly as described. **It is your sole responsibility to consult and comply with all local regulations and property restrictions regarding the use of cameras.**

When enabled, your vehicle's cameras and sensors (if equipped) remain powered on and ready to record suspicious activity around your vehicle when Model Y is locked and in Park. Think of Sentry Mode as an intelligent vehicle security system that alerts you when it detects possible threats nearby.

If a threat is detected or the vehicle sensors determine there is a lot of jerky movement like when getting towed or shaken, Sentry Mode:

- Pulses the headlights.
- Sounds the alarm.
- Displays a message on the touchscreen that indicates cameras may be recording to inform individuals outside of the vehicles.
- Alerts you of the alarm on the mobile app.
- Saves footage of the event to a USB drive (if installed).

Sentry Mode is disabled by default. You can use voice commands or the Tesla mobile app to easily enable or disable Sentry Mode. To enable Sentry Mode using voice commands, say "Keep Tesla safe," "Keep my car safe," "Sentry on," or "Enable Sentry" (see [Voice Commands on page 14](#)).

NOTE: For some vehicles manufactured after approximately November 1, 2021, the center console USB ports may only support charging devices. Use the USB port inside the glove box for all other functions.

Sentry Mode requires your Battery to be at least 20% charged. If the Battery falls below 20%, Sentry Mode turns off and the mobile app sends you a notification. Power consumption may increase when Sentry Mode is active.

NOTE: When Sentry Mode is enabled, the Security Alarm settings (**Controls > Safety > Security Alarm**) are not available.



CAUTION: Do not rely on Sentry Mode to protect Model Y from all possible security threats. Sentry Mode uses many factors to determine whether to activate the security alarm. All impacts may not be detected and the alarm may not activate in all situations. While it may help deter some threats, no security system can prevent all attacks.

NOTE: Sentry Mode only sends notifications to the mobile app when the alarm is triggered or sudden jerky motions are detected by the vehicle. If Sentry Mode doesn't consider an event a clear threat, the vehicle records footage but doesn't trigger the alarm.

How to Use Sentry Mode (With a USB Flash Drive)

1. Sentry Mode requires a properly formatted USB drive inserted in your vehicle's USB port. Vehicles manufactured beginning approximately 2020 are equipped with a pre-formatted USB flash drive in the glove box. There are two ways to format the USB drive:
 - Insert the USB drive into the USB port and navigate to **Controls > Format USB Drive**. Your vehicle automatically formats the USB drive for you.
 - Format the USB drive on a computer. See [USB Drive Requirements for Recording Videos on page 148](#) for more information.
2. Insert the USB drive into the vehicle's USB port, preferable the one in the glove box (if equipped).
3. With your vehicle in Park, enable Dashcam by navigating to **Controls > Safety > Dashcam** (Dashcam must be enabled for Sentry Mode to work).
4. Touch **Controls > Sentry Mode > On**. Once enabled, the Sentry Mode icon in **Controls** turns red.



NOTE: Rear camera recordings are available only on vehicles manufactured after approximately February 2018.

When enabled, Sentry Mode is idle, ready to sound the alarm and save a recording of the security event if triggered. See [Viewing Video Recordings on page 148](#) for information on viewing footage.

5. To manually enable/disable Sentry Mode until the next drive, touch the Sentry Mode icon. Sentry Mode is Off when the icon is no longer red.



Turn Sentry Mode **Off** in **Controls > Safety > Sentry Mode** to disable for more than one drive cycle.

How to Use Sentry Mode (Without a USB Flash Drive)

When Sentry mode is enabled and a security event is detected but without a USB drive plugged into a USB port, your vehicle alerts you through the mobile app, without any camera recordings.

Sentry Mode Settings

• Exclude specific locations

In **Controls > Safety > Sentry Mode**, you can determine if you want Sentry Mode to not enable in certain locations (see [Home, Work, and Favorite Destinations](#) on page 161 for more information):

- **Exclude Home:** Sentry Mode does not automatically enable at the location set as Home in your Favorites list.
- **Exclude Work:** Sentry Mode does not automatically enable at the location set as Work in your Favorites list.
- **Exclude Favorites:** Sentry Mode does not automatically enable at any location in your Favorites list.

NOTE: To recognize a location listed as Home, Work, or a Favorite, Model Y must be parked within approximately 500 meters of the saved location.

To set up your Home or Work location, touch **Navigate > Set Home/Set Work**. To set up a **Favorite**, touch the star when viewing an address on the map. Manually turning Sentry Mode on or off using the touchscreen or the mobile app overrides your Home, Work, or Favorite exclusion preferences until your next drive.

• Set Camera-Based Detection

When **Camera-Based Detection** is enabled, Sentry Mode uses the vehicle's external cameras in addition to vehicle sensors to detect a security event while parked. If disabled, your vehicle only saves clips to the USB drive if a physical threat is detected. To adjust, touch **Controls > Safety > Sentry Mode > Camera-Based Detection**.

• View Live Camera

NOTE: View Live Camera requires premium connectivity and version 4.2.1 (or newer) of the Tesla mobile app installed on a phone that has been paired as a key to Model Y.

When Sentry Mode is enabled, use the mobile app to remotely view the area surrounding Model Y as seen through the exterior cameras. To enable, touch **Controls > Safety > Sentry Mode > View Live Camera via Mobile App** on the touchscreen to see what Sentry Mode records in real-time. Ensure there are no occupants in the vehicle and all doors are locked. Then, on the mobile app, navigate to **Safety > Sentry Mode > View Live Camera**.

When **View Live Camera** is actively in use, Model Y periodically flashes its exterior lights and displays a message on the touchscreen to notify others that the area surrounding the vehicle is being viewed through the cameras.

View Live Camera is limited to approximately 15 minutes of cumulative usage per day.

You can also enable Dog Mode at the same time and switch the live camera view to see through the interior camera on the mobile app. See [Keep Climate On, Dog, and Camp on page 151](#) for more information. This feature is not supported in vehicles with Autopilot computer 2.0 or 2.5. Touch **Controls > Software > Autopilot computer** to find out which computer your vehicle has.

NOTE: If Dog and Sentry are enabled at the same time, Sentry defaults to **Disable Sentry Sounds** to protect your pet.

NOTE: Video quality can vary depending on network connectivity. No audio is captured.

NOTE: The live camera feed is fully encrypted and cannot be accessed by Tesla.

See [Viewing Video Recordings on page 148](#) for more information on viewing Sentry Mode footage.

NOTE: When the internal storage reaches full capacity, new recordings overwrite the older recordings.



USB Drive Requirements for Recording Videos

NOTE: For some vehicles manufactured after approximately November 1, 2021, the center console USB ports may only support charging devices. To play media files or to format and view video footage, use the USB-A port in the glovebox (see [Interior Electronics on page 9](#)).

NOTE: The ability to format and store video footage on USB drives may not be available on your vehicle depending on the date of manufacture and vehicle configuration.

Some features require you to use a USB drive (for example, Dashcam, Sentry Mode) that meet these requirements:

- Minimum storage capacity of 64 GB. Use a USB drive with as much available storage as possible. Video footage can occupy a large amount of space.
- A sustained write speed of at least 4 MB/s. Note that sustained write speed differs from peak write speed.
- USB 2.0 compatible. If using a USB 3.0 drive, it must also support USB 2.0.
- Properly formatted (either automatically or [manually on page 148](#)).

NOTE: In some market regions you can purchase recommended USB drives on <http://www.tesla.com>.

Automatically Formatting a USB Drive

Insert the USB drive into a front USB port that supports the ability to format, save, and view video footage (see [Interior Electronics on page 9](#)). Then, touch **Controls > Safety > Format USB Drive**. This automatically formats the USB drive as exFAT and creates folders for TeslaCam. The USB drive is now ready to record and save video footage.

Format USB Drive is available only when a USB drive (with one or fewer partitions) is inserted into a front USB port. Choosing **Format USB Drive** erases any existing content on the USB drive. Before using this feature, move any content you want to keep to a different device.

Manually Formatting a USB Drive

If Model Y is unable to format the USB drive, format it using a computer:

1. Format the USB drive as exFAT, MS-DOS FAT (for Mac), ext3, or ext4 (NTFS is currently not supported).
2. Create a base-level folder titled **TeslaCam**. You can use one USB drive for Dashcam, Sentry Mode, and audio files, but you must create separate partitions or folders on the exFAT USB drive.
3. Once formatted, insert the USB drive into the glovebox USB port (if equipped), otherwise use a front USB port in the center console. Do not use a rear USB port because they can only charge devices. It may take a few seconds for Model Y to recognize the USB drive.
4. Once recognized, ensure icons for Dashcam and Sentry Mode are available when you touch **Controls**. Model Y is now ready to record videos.

NOTE: You may need to first enable Sentry Mode (if equipped) by touching **Controls > Sentry**.

Viewing Video Recordings

If footage is saved, you can view the clips on the touchscreen or a computer.

When the USB drive runs out of storage space, video footage can no longer be saved. To prevent the USB drive from getting full, regularly move saved videos to another device and delete them from the USB drive.

When enabled, Dashcam and Sentry Mode records footage in cycles. Footage is continuously overwritten unless you save it. You must save your desired footage to view it, otherwise the footage is erased and overwritten. See [Sentry Mode on page 146](#) and [Dashcam on page 144](#) for information on saving footage. Four videos are recorded for each saved clip, one from each camera (front, rear, left, and right).

NOTE: Rear camera recordings are only available on vehicles manufactured after approximately February 2018.

Viewing on the Touchscreen

You can view recorded footage on the touchscreen when Model Y is in Park. Touch the Dashcam icon located in the app launcher. The tabs display a list of all video clips, organized by location and timestamp. Pause, rewind, fast forward, and delete clips as needed. Swipe to the right or press and hold to quickly delete certain clips.

Navigate to **Controls > Safety > Delete Dashcam Clips** to delete all Dashcam and Sentry Mode footage.

NOTE: Dashcam recording pauses when you launch the Viewer.

Viewing on a Computer

Insert the USB drive into a computer and navigate to the TeslaCam folder.

The TeslaCam folder contains these sub-folders:

- **RecentClips:** Contains up to 60 minutes of recorded content.
- **SavedClips:** Contains all recordings that are saved and renamed from the RecentClips folder.
- **SentryClips:** Contains recordings from all Sentry Mode security events. If storage space on the USB drive becomes limited, the oldest Sentry Clips are deleted to provide space for new ones. Once deleted, you cannot retrieve them.



Overview of Climate Controls

Climate controls are available at the bottom of the touchscreen. By default, climate control is set to **Auto**, which maintains optimum comfort in all but the most severe weather conditions. When you adjust the cabin temperature while in the **Auto** setting, the system automatically adjusts the heating, air conditioning, air distribution, and fan speed to maintain the cabin at your selected temperature.

Touch the displayed temperature at the bottom of the touchscreen to access the main climate controls screen, where you can adjust your climate preferences. You can return to Auto at any time by touching **Auto**. Touch the power button on the main climate controls screen to toggle on or off. For quick access to common controls, touch **<** or **>** to display the climate popup.

While the cabin is warming up or cooling down, the fan speed may be reduced. The touchscreen displays **Warming Up** or **Cooling Down** while getting to your preferred temperature.

NOTE: The climate control system is powered by the high voltage Battery. Therefore, prolonged use decreases driving range.

⚠ WARNING: To avoid burns resulting from prolonged use, individuals who have peripheral neuropathy, or whose capacity to feel pain is limited because of diabetes, age, neurological injury, or some other condition, should exercise caution when using the climate control system and seat heaters.

Adjusting Climate Control Settings

NOTE: Easily adjust your climate preferences, such as turning on the seat heater or changing the cabin temperature, hands-free by using voice commands (see [Voice Commands on page 14](#)).

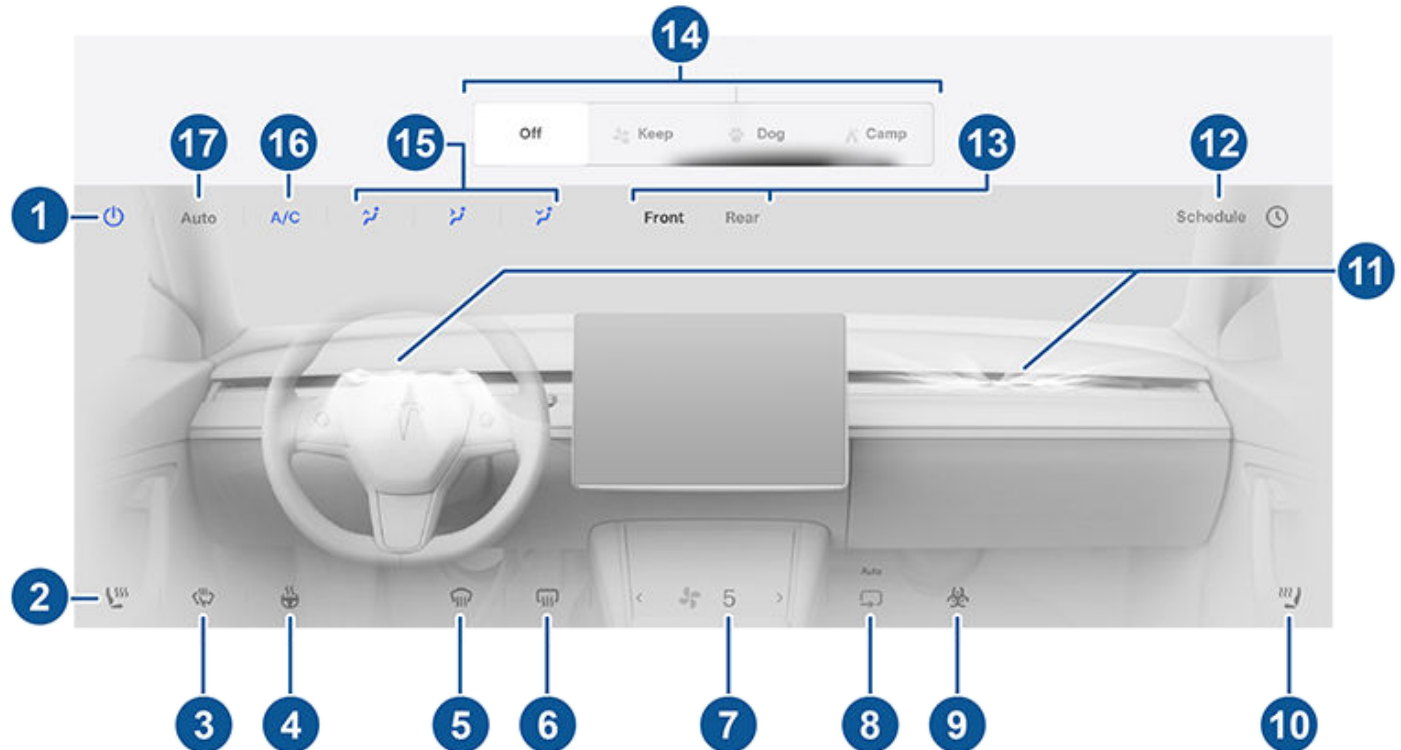

NOTE: For one-touch access to seat heaters and defrosters, you can add these controls to My Apps. See [Customizing My Apps on page 6](#).

1. Touch to turn the climate control system on or off.
2. Touch the driver's side seat icon to adjust seat heaters for the driver. The seat operates at three levels from 3 (highest) to 1 (lowest). The seat icon displays twisting lines that turn red (heating) corresponding with the set level. **Auto**, which displays when the climate control system is set to **Auto**, warms the front seats based on cabin temperature. For one-touch access to seat heaters, you can add them to the touchscreen's bottom bar (see [Customizing My Apps on page 6](#)).



Operating Climate Controls

3. Touch to turn on the wiper defrosters (if equipped). Wipers defrost for 30 minutes then turn off automatically.
4. Touch to control the heated steering wheel, if equipped. The icon displays red twisting lines that correspond to the set level. If set to **Auto**, the steering wheel is heated as needed, based on cabin temperature, whenever the climate control system is set to **Auto**. For one-touch access, you can add this control to the touchscreen's bottom bar (see [Customizing My Apps on page 6](#)).
5. The windshield defroster distributes air flow to the windshield. Touch once to *defog* the windshield (the icon turns amber). Touch a second time to *defrost* the windshield. Touch a third time to turn off and restore the air distribution, heating, and fan to their previous settings.
6. Touch to warm up the rear windshield. After 15 minutes, the rear window defroster automatically turns off. The exterior side mirrors and charge port are also heated whenever the rear window defroster is operating. See [Cold Weather Best Practices on page 155](#) for more information on preparing for cold weather.
7. Use the slider to adjust the fan speed. When in **Auto**, the fan speed levels change to **Low/ Medium/ High**.
NOTE: Adjusting the fan speed may change the selected setting for how air is drawn into Model Y in order to increase or reduce air flow.
8. Touch to control the flow of air inside the cabin. Air can be drawn into Model Y from outside or air can be recirculated inside the cabin.
9. If your Model Y is equipped with the medical-grade HEPA (High Efficiency Particulate Air) filter, this filter ensures the best quality air inside the cabin whenever the climate control system is on and outside air is entering the cabin (recirculate is off). The HEPA filter is extremely effective at removing particles, including pollution, allergens, bacteria, pollen, mold spores, and viruses. Both the HEPA filter and the secondary filtration system also contain activated carbon to remove a broad spectrum of odors and gases. When you engage Bioweapon Defense Mode, the positive pressure inside the cabin minimizes the amount of outside air that can enter the vehicle.
NOTE: Some gases, such as carbon monoxide, are not effectively removed by activated carbon.
10. Touch the passenger's side seat icon to adjust seat heaters for the front passenger. The seat operates at three levels from 3 (highest) to 1 (lowest). The seat icon displays twisting lines that turn red (heating) corresponding with the set level. **Auto**, which displays when the climate control system is set to **Auto**, warms the front seats based on cabin temperature. For one-touch access to seat heaters, you can add them to the touchscreen's bottom bar (see [Customizing My Apps on page 6](#)).
11. Touch to adjust how air flows from the front vents. See [Ventilation on page 154](#).
12. When Model Y is in Park, touch **Schedule** to set a recurring daily time when you want Model Y to be ready to drive by preconditioning the Battery and cabin climate and/or charging during off-peak hours (see [Scheduled Precondition and Charge on page 178](#)).
13. Touch to adjust the climate settings for the front or rear cabin. If **Auto** is enabled for the rear cabin and a passenger is detected, the set temperature is maintained for the rear cabin (see [Ventilation on page 154](#)).
14. When in Park, these settings display to allow you to keep the climate control system operating, even when you leave Model Y (see [Keep Climate On, Dog, and Camp on page 151](#)).
NOTE: To turn them on, the Battery's charge level must be at least 20%.
15. Choose where air flows into the front cabin (windshield, face-level, or foot-level vents). You can choose one or more vents.
16. Touch to turn the air conditioning system on or off. Turning it off reduces cooling, but saves energy.
NOTE: Because Model Y runs much quieter than a gasoline-powered vehicle, you may notice the sound of the air conditioning compressor as it is operating. To minimize noise, reduce the fan speed.
17. Touch **Auto** to turn the Auto setting on or off.
NOTE: When in **Auto**, the fan speed may automatically lower to reduce the sound of ambient noise while on a call. For more information, see [Phone, Calendar, and Web Conferencing on page 69](#).



Climate Popup

Touch the temperature arrows on the bottom of the touchscreen to display a popup for easy access to some of the most common climate controls:

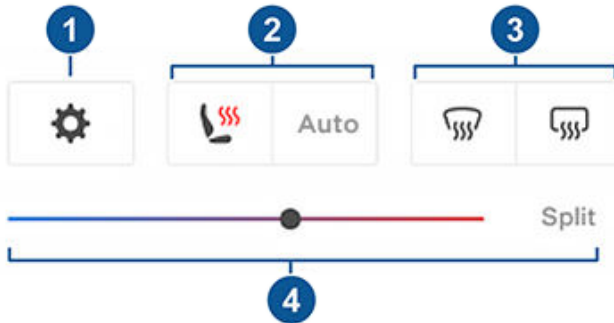

NOTE: For one-touch access to seat heaters and defrosters, you can add these controls to My Apps. See [Customizing My Apps on page 6](#).

1. Touch to access the main climate controls screen.
2. Enable or disable heated seats.
3. Enable or disable the front or rear windshield defrosters.
4. Modify the cabin temperature by dragging the slider. You can also enable temperature splitting which allows the driver and front passenger to customize their own climate preferences. The front passenger can touch the temperature icon on the bottom of the touchscreen or the main climate controls screen to adjust. Touch **Split** again to disable climate splitting.

Keep Climate On, Dog, and Camp

The **Keep Climate On**, **Dog**, and **Camp** settings allow you to keep the climate control system running when in Park, even after you've left Model Y or choose to stay inside the vehicle. These settings are useful when it is important to maintain the cabin temperature in hot or cold weather conditions. For example, when leaving groceries in Model Y on hot days, you may want to use Keep Climate On to prevent spoilage.

Dog is designed to maintain a comfortable cabin temperature for your pet while you actively and frequently monitor this temperature using the mobile app (which requires both your phone and the vehicle to have cellular connectivity). When in Dog, the touchscreen displays the current cabin temperature to inform people passing by that your pet is safe. This setting is not intended for people, and should only be used for short periods of time while you stay in close proximity should you need to return to the vehicle in situations where the temperature can no longer be maintained.

NOTE: To avoid accidentally pressing the window switch (such as your dog stepping on it), the windows cannot be rolled down while Dog is enabled.

NOTE: If Dog and Sentry are enabled at the same time, Sentry defaults to **Disable Sentry Sounds** to protect your pet. See [Sentry Mode on page 146](#) for more information.

Live Camera view is now available if Sentry Mode or Dog Mode, or both, are enabled. When Sentry Mode is on, the cameras show a live view of the vehicle's surroundings. When Dog Mode is on, the interior cabin camera shows the inside of the vehicle so you can check on your pet at any time. If both are enabled, switch the camera views by touching the gray circles or the interior icon that correspond to different cameras on the mobile app. See [Sentry Mode on page 146](#) for more information.

NOTE: Enabling the interior cabin camera for Dog or Sentry Mode requires the mobile app version 4.15.0 or higher. This feature is not supported in vehicles with Autopilot computer 2.0 or 2.5. Touch **Controls > Software > Autopilot computer** to find out which computer your vehicle has.

NOTE: **View Live Camera** is limited to approximately 15 minutes of cumulative usage per day.

Camp allows you to power electronics through the USB ports and low voltage outlet in addition to maintaining the cabin temperature. The touchscreen remains on so you can play music, browse the internet, play games in the arcade, or watch shows in Tesla Theater. You can also control media and climate settings from a paired phone. Camp is ideal for remaining inside your vehicle, such as camping or staying with a child. While active, Sentry Mode and the vehicle alarm system are disabled. Walk-Away Door Lock is inactive.

To operate Keep Climate On, Dog, or Camp:

1. Make sure the Battery's charge level is at least 20%.
2. Engage Park. The **Keep Climate On**, **Dog**, and **Camp** settings are available only when Model Y is in Park.
3. If necessary, adjust the climate settings.
4. On the climate controls screen, touch **Keep Climate On**, **Dog**, or **Camp**.

NOTE: You can also control **Dog** and **Camp** from the mobile app, by swiping up from the gray bar on the Climate screen.

The climate control system attempts to maintain your climate settings until you shift out of Park or manually turn it off. Avoid using Keep Climate On, Dog, or Camp when the Battery's charge level is low.

Dog cannot be enabled if the cabin temperature is too hot, or if the vehicle detects an issue with the climate control system. Ensure that the cabin temperature is at a safe and comfortable level before enabling Dog.





If **Keep Climate On**, **Dog**, or **Camp** are on, the Tesla mobile app attempts to repeatedly send notifications reminding you to check on anything that you have left in Model Y if:

- The Battery's charge level drops below 20%.
- The vehicle detects an issue with the climate control system.
- The cabin temperature changes significantly from the level initially set for Dog.



Operating Climate Controls

NOTE: Software updates cannot be performed when Keep Climate On, Dog, or Camp is active.

-  **WARNING:** Never leave a child unattended in your vehicle.
-  **WARNING:** Check local laws for any restrictions on leaving pets unattended in your vehicle.
-  **WARNING:** You are responsible for the safety of your dog or pet. Never leave them in Model Y for long periods of time. Constantly monitor the vehicle temperature and their well-being. Make sure you have sufficient cellular coverage on your phone and time to return to the vehicle, if necessary.
-  **WARNING:** In the unlikely event that your climate control system needs service or is not working as expected, avoid using Keep Climate On, Dog, and Camp. Never rely on your vehicle to protect something irreplaceable.
-  **WARNING:** You can adjust and monitor the climate control system remotely using the mobile app. However, if you use the mobile app to turn off the climate control system, Keep Climate On, Dog, and Camp stop operating.

Cabin Overheat Protection

Cabin Overheat Protection prevents the cabin from getting too hot in scorching ambient conditions. While not necessary to activate whenever you leave Model Y, the climate control system can reduce and maintain the temperature of your vehicle's cabin. This can prevent the cabin from getting too hot after leaving it parked in the sun, making the vehicle more comfortable when you return. Cabin Overheat Protection may take up to 15 minutes to enable once you exit the vehicle. This feature is intended for passenger comfort and has no impact on the reliability of your vehicle's components.



To turn on, touch **Controls > Safety > Cabin Overheat Protection** and choose:

- **On:** The air conditioning operates when the cabin temperature exceeds 40° C, or the selected temperature if available, on the touchscreen or mobile app. Customizing temperatures may require the most recent version of the mobile app.
- **No A/C:** Only the fan operates to prevent touch surfaces from getting too hot.
- **Off:** Disables Cabin Overheat Protection.

You can also enable Cabin Overheat Protection remotely through the mobile app by touching **Climate**. Swipe up on the bottom menu and select a setting under **Cabin Overheat Protection** (see [Mobile App on page 64](#)).

Cabin Overheat Protection operates until 12 hours has elapsed once you exit Model Y, or until the Battery energy drops below 20%, whichever comes first. Using Cabin Overheat Protection requires energy from the Battery, which may decrease range.

NOTE: To enable **Cabin Overheat Protection, Tilt/Intrusion** must be turned off.

-  **WARNING:** Due to automatic shut-off, extreme outside conditions, or other potential inability to maintain the selected temperature, the inside of the vehicle can become dangerously hot, even when Cabin Overheat Protection is enabled. If you experience temperatures exceeding the selected temperature repeatedly, contact Tesla service.
-  **WARNING:** Never leave children or pets in the vehicle unattended. Due to automatic shut-off or extreme outside conditions, the inside of the vehicle can become dangerously hot, even when Cabin Overheat Protection is enabled.

Climate Control Operating Tips

- When you use the mobile app to turn on the climate control system, it automatically turns off when the charge level drops to 20%, or if two hours has passed. To cool or heat the cabin for a longer period of time, charge the vehicle and re-enable your climate control preference through the mobile app.
- You can improve the efficiency of the cabin heating by reducing your selected acceleration mode (see [Acceleration Modes on page 93](#)). This allows the heat pump system to take more heat from the Battery to efficiently heat the cabin, instead of maintaining the Battery's ability to provide peak acceleration performance. This helps to maximize driving efficiency in colder weather. Note that when subsequently increasing the acceleration mode, the Battery requires time to warm up before the increased level of acceleration is available.
- If the climate control system is louder than you prefer, manually reduce the fan speed.
- In addition to cooling the interior, the air conditioning compressor also cools the Battery. Therefore, in hot weather, the air conditioning compressor can turn on even if you turned it off. This is normal because the system's priority is to cool the Battery to ensure it stays within an optimum temperature range to support longevity and optimum performance.
- Even when not in use, you may hear Model Y emit a whining noise or the sound of water circulating. These sounds are normal and occur when the internal cooling systems turn on to support various vehicle functions, such as maintaining the low voltage battery and balancing the temperature of the high voltage Battery.
- To ensure the climate control system operates efficiently, close all windows and ensure that the exterior grille in front of the windshield is free of ice, snow, leaves, and other debris.
- In very humid conditions, it is normal for the windshield to fog slightly when you first turn on the air conditioning.
- It is normal for a small pool of water to form under Model Y when parked. Extra water produced by the dehumidifying process is drained underneath.



- Model Y is designed to automatically maximize efficiency; therefore, your air conditioning compressor and external fan may run and make noise even when the outside temperature is cold and your vehicle is heating or supercharging.
- To reduce the temperature in the cabin in hot weather conditions, the fan may turn on to vent the cabin when the vehicle is parked. This occurs only if the battery's charge level is above 20%.



Ventilation

Adjusting the Front Vents

Model Y has a unique horizontal face-level vent that spans the width of the dashboard. Using the touchscreen, you can pinpoint exactly where you want to direct the air flowing from this vent when heating or cooling the front cabin area.

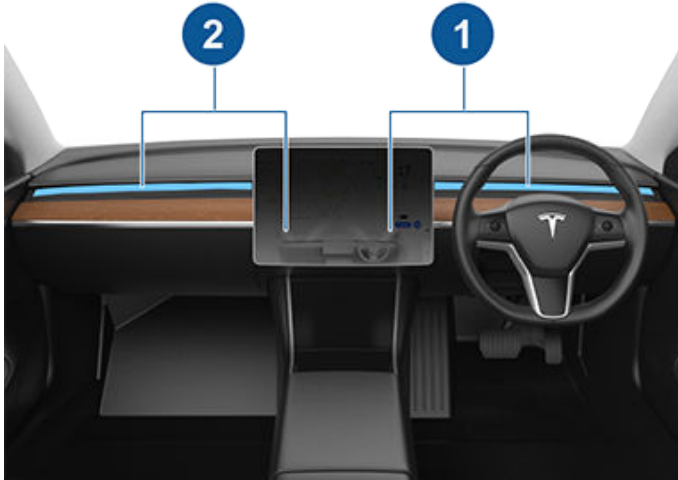

1. Driver vent and controls
2. Passenger vent and controls

When the face-level vent is on you can adjust the direction of the air flow from each vent. To adjust the direction of the air flow, simply touch the radiating air waves from the corresponding vent on the touchscreen. The air flows in a single stream when centered or splits into mirrored air streams when air is directed outward or inward from the center of the vent.

When Model Y detects that there are no passengers sitting in the passenger seat, the passenger vent and controls automatically turn off. Adjust the climate settings to enable passenger air flow.

NOTE: You can direct the face-level vents toward the windows to help defrost or defog them.

NOTE: When you split a vent into two separate air flows, the air flow in each direction is not as strong as when all air is flowing in a single direction.

NOTE: Outside air is drawn into Model Y through the grill in front of the windshield. Keep the grill clear of obstructions, such as leaves and snow.

Adjusting the Rear Vents

Model Y has vents located at the back of the center console where air flows from when the setting is turned on from the touchscreen. To direct the flow of air in the rear cabin area, adjust the vents at the rear of the center console up, down, or from side to side as necessary.

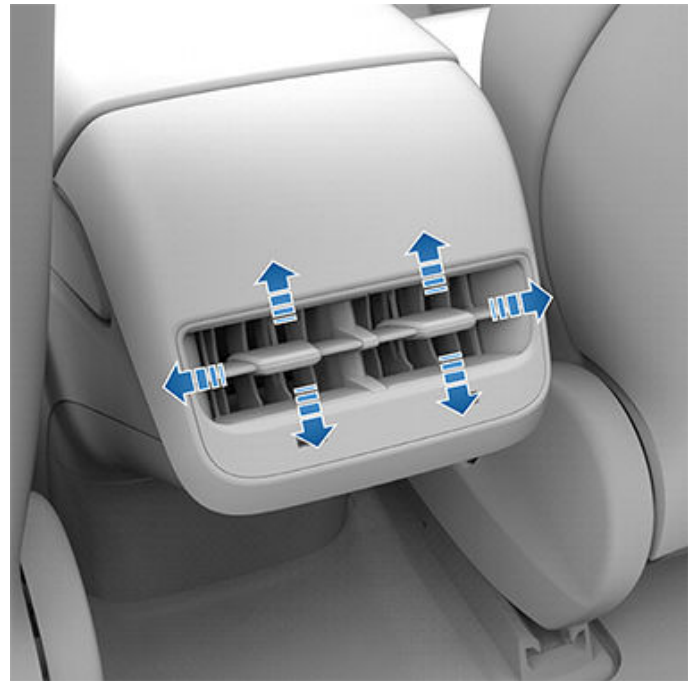

Cabin Air Filter(s)

Model Y has one or more air filters to prevent pollen, industrial fallout, road dust and other particles from entering through the vents.

NOTE: Cabin air filter(s) require periodic replacement. See [Service Intervals on page 183](#).



To ensure that Model Y provides you with the best ownership experience possible in harsh cold weather conditions, follow these best practices.

Before Driving

When snow and ice accumulate on your vehicle, moving parts, such as the door handles, windows, mirrors, and wipers can freeze in place. To achieve maximum range and performance, it is helpful to warm the cabin and Battery before driving. There are several ways to do so:

- Touch **Controls > Schedule** (also available on both the charging and climate control screens) to set a time when you want your vehicle to be ready to drive (see [Scheduled Precondition and Charge on page 178](#)).
- In the mobile app, navigate to **Climate** to customize the temperature at which you want to heat the cabin. This also warms the high voltage Battery as needed.
- In the mobile app, navigate to **Climate > Defrost Car** to melt snow, ice, and frost on the windshield, charge port, windows, and mirrors. This also warms the high voltage Battery as needed.

NOTE: Tesla recommends activating climate settings at least 30–45 minutes before departure (see [Operating Climate Controls on page 149](#)). Preconditioning times depend on outside temperature and other factors. The mobile app will notify you once your vehicle has reached the desired preconditioning temperature.

Charge Port

If your charge port latch freezes in place and a charging cable becomes stuck in the charge port, try manually releasing the charge cable. See [Manually Releasing Charge Cable on page 176](#).

In extremely cold weather or icy conditions, it is possible that your charge port latch may freeze in place. In these weather conditions, you can thaw ice on the charge port latch so the charge cable can be removed and inserted. To do so, enable **Defrost Car** using the mobile app.

You can also prevent the occurrence of a charge port latch freezing in place by using the **Schedule** settings (see [Scheduled Precondition and Charge on page 178](#)).

NOTE: If your charge port latch is frozen in place, it may not lock the charging cable in place when inserted, but it can still charge at a slow AC rate even if the latch is not engaged.

Charging

By using Trip Planner (if available) to navigate to a Tesla charging location, Model Y pre-heats the high voltage Battery to ensure when you arrive at the charger, the temperature of the Battery is optimal and ready to charge. This reduces the amount of time it takes to charge. See (see [Trip Planner on page 163](#)).

NOTE: Tesla recommends using Trip Planner to navigate to a charging location for at least 30–45 minutes before arrival to ensure optimal Battery temperature and charging conditions. If the drive to the charging location is less than 30–45 minutes, consider preconditioning the Battery before driving (see [Before Driving on page 155](#)).

NOTE: The thermal system may produce steam under certain conditions for vehicles equipped with a heat pump (to determine if your vehicle has a heat pump, touch **Controls > Software > Additional Vehicle Information**). For example, odorless steam can come from the front of your vehicle while charging at a Supercharger in cold temperature. This is normal and not a cause for concern.

Windows

In the mobile app, go to **Climate** and select **Defrost Car**, which helps melt snow, ice, and frost on the windshield, windows, and mirrors.

In cold temperatures, Model Y automatically makes a slight adjustment to the position of the windows to make it easier to open doors.

NOTE: Always connect to an external, low voltage power supply before opening a door when the vehicle has no power to avoid breaking a window.

Use the mobile app to schedule a service appointment for Tesla to provide hydrophobic coating to the side and rear windows (not the front windshield) for a nominal fee.

Doors

In severe winter conditions, ice buildup can make it more difficult to open door handles. You can use the mobile app to pop open the driver door in this situation.

1. In the mobile app, touch and hold any of the four quick control buttons and follow the instructions to customize quick controls with **Unlatch Door**.
2. When you are next to your car, touch **Unlatch Door** to pop open the driver door.

Removing Ice From Door Handle

In severe winter conditions, ice buildup within the door handle can prevent the door handle from opening. The process for freeing a Model Y door handle is slightly different than others to remove ice buildup.

NOTE: Preemptively applying WD-40 to the door handle pivot pins can help prevent ice buildup inside your door handle.

 **CAUTION:** Do not attempt to use tools or excessive force to release the door handle from ice buildup.

Perform the following to remove ice from the door handle:

1. Forcefully press the frontmost part of the door handle. It will rock slightly inward to help break the ice.



Cold Weather Best Practices

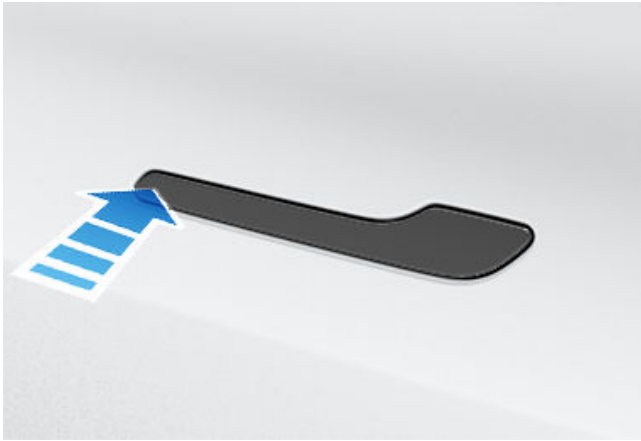

2. Press the rearmost part of the door handle to try to open as you normally would.
3. Once the door handle is able to move, open and close it a few more times to release any remaining ice buildup. Make sure the door handle is fully pressed in (retracted) prior to entering the vehicle, and check that the door is fully closed before driving away.

Mirrors

If ice buildup is expected when parking, turn off **Auto-Fold Mirrors**. Touch **Controls > Auto-Fold**. Ice can prevent exterior side mirrors from folding or unfolding.

NOTE: Side mirrors automatically heat as needed during preconditioning, or when the rear defroster is turned on.

Wipers

If you expect snow or ice to build up when parked, touch **Controls > Service > Wiper Service Mode**. This raises the wipers against the windshield so they can defrost when the windshield defrosts (see [Wipers and Washers on page 84](#)). You can also turn on wiper defrosters (if equipped). See [Operating Climate Controls on page 149](#).

Tires and Tire Chains

Use winter tires to increase traction in snowy or icy conditions. You can purchase winter tires on the Tesla Shop (see [Seasonal Tire Types on page 190](#)).

Tire chains provide additional traction when driving in snowy or icy conditions. Check local regulations to determine if tire chains are recommended or required during winter months. See [Using Tire Chains on page 190](#) for more information.

Your vehicle's tire pressures will drop in cold ambient temperatures. If the TPMS indicator light appears, inflate the tires before driving. The tires will lose one PSI for every 6° C drop in outside temperature (see [Tire Care and Maintenance on page 185](#)). Proper tire pressures help protect tires from potholes and improve range when properly inflated.

While Driving

Cold weather can increase energy consumption because more power is required for driving, cabin and Battery heating. Follow these suggestions to reduce energy consumption:

- Use seat heaters to keep warm. Seat heaters use less energy than the cabin heater. Lowering the cabin temperature and using seat heaters reduces energy consumption (see [Operating Climate Controls on page 149](#)).
- Slow down your driving and avoid frequent and rapid acceleration.
- You can improve the efficiency of the cabin heating by reducing your selected acceleration mode (see [Acceleration Modes on page 93](#)). This allows the heat pump system to take more heat from the Battery to efficiently heat the cabin, instead of maintaining the Battery's ability to provide peak acceleration performance. This helps to maximize driving efficiency in colder weather. Note that when subsequently increasing the acceleration mode, the Battery requires time to warm up before the increased level of acceleration is available.

Regenerative Braking

Regenerative braking can be limited if the Battery is too cold. As you continue to drive, the Battery warms up and regenerative power increases (see [Regenerative Braking on page 86](#)).

NOTE: Limited regenerative braking can be avoided if you allow enough time to precondition your vehicle or if you use **Schedule** to precondition Model Y before your departure time (see [Scheduled Precondition and Charge on page 178](#)).

NOTE: Installing winter tires can result in temporarily reduced regenerative braking power but after a short period of driving, Model Y recalibrates to correct this. Touch **Service > Wheel & Tire > Tires** to select winter tires and quicken this process.

Cold Battery



A blue snowflake icon appears on your touchscreen when some of the stored energy in the Battery is unavailable because the Battery is cold. This portion of unavailable energy displays in blue on the Battery meter. Regenerative braking, acceleration, and charging rates may be limited. The snowflake icon no longer displays when the Battery is sufficiently warm.

After Driving

Leave Model Y plugged in when not in use. This uses the charging system, rather than the Battery itself, to keep the Battery warm (see [High Voltage Battery Information on page 171](#)).



Scheduled Precondition

When parked, use the **Controls > Schedule** settings, available on both the charging and climate control screens, to set a time when you want to precondition Model Y (see [Scheduled Precondition and Charge on page 178](#)). You can also use **Schedule** to prevent the charge port latch freezing in place. Your vehicle determines the appropriate time to begin preconditioning so that cabin and Battery are warm by your planned departure time.

Tesla recommends that you also schedule a charge with your precondition to ensure that your vehicle has sufficient energy for the trip. When Model Y is not plugged in, preconditioning operates but only when the Battery's charge level is above 20%.

Storage

If you leave Model Y parked for an extended period of time, plug the vehicle into a charger to prevent normal range loss and to keep the Battery at an optimal temperature. Your vehicle is safe to stay plugged in for any length of time.

When not in use, Model Y enters a sleep mode to conserve energy. Reduce the number of times you check your vehicle's status on the mobile app, as this automatically wakes up your vehicle and starts normal energy consumption.



Hot Weather Best Practices

To ensure that Model Y provides you with the best ownership experience possible in hot ambient conditions, follow these best practices.

Before Driving

There are several ways to prepare your vehicle for a drive, without having to get into an already hot vehicle:

- Precondition the cabin by moving the direction of air flow from the vents, and turn the seat heaters on or off. In the mobile app, navigate to **Climate** to customize the temperature at which you want to cool the cabin.
- Touch **Schedule**, available on both the Charging and Climate Control screens, to set a time when you want your vehicle to be ready to drive (see [Scheduled Precondition and Charge on page 178](#)).
- Enable **Cabin Overheat Protection**, which prevents the cabin from getting too warm in hot ambient conditions. You can choose whether you want the A/C or just the fan to run when the temperature in the cabin exceeds 105° F (40° C) or the selected temperature (if available).
- In the mobile app, navigate to **Controls** to vent the windows.

NOTE: Tesla recommends activating climate settings at least 30–45 minutes before departure (see [Operating Climate Controls on page 149](#)). Preconditioning times depend on outside temperature and other factors. The mobile app will notify you once your vehicle has reached the desired preconditioning temperature.

After Driving

Leave Model Y plugged in when not in use, especially if using Preconditioning or Cabin Overheat Protection. This uses the charging system, rather than the battery itself, to maintain a comfortable temperature (see [High Voltage Battery Information on page 171](#)). In addition, there are several ways to minimize a hot cabin:

- Before leaving your vehicle (to run errands, for example), use Dog Mode to keep the cabin cool for pets or perishable goods. See [Keep Climate On, Dog, and Camp on page 151](#) for more information.
- Tesla recommends turning the air conditioning off approximately 30 seconds before pressing Park to reduce puddling below the vehicle.
- Park in the shade to help reduce power consumption and maintain cooler cabin temperatures.
- Use a sun shade (available on the Tesla Shop) if you have to park outside in the sun.
- When parked, plug in Model Y and **Schedule** your charging. Your vehicle determines the appropriate time to begin charging so it is complete during off-peak hours. The cabin and Battery are also prepared by your set departure time. For more information, see [Scheduled Precondition and Charge on page 178](#).

Charging

When using Trip Planner or navigating to a Supercharger station, your vehicle automatically prepares the Battery for most efficient charging. In extreme heat, you may not see the message that the vehicle is preconditioning the Battery while navigating to a Supercharger, but it is still preparing the Battery for charging.

NOTE: Tesla recommends using Trip Planner to navigate to a charging location for at least 30–45 minutes before arrival to ensure optimal Battery temperature and charging conditions. If the drive to the charging location is less than 30–45 minutes, consider preconditioning the Battery before driving (see [Before Driving on page 155](#)).

If possible, leave your vehicle plugged into a charger whenever not in use, even in warm weather, especially if using Preconditioning or Cabin Overheat Protection.

Storage

If you leave Model Y parked for an extended period of time, plug the vehicle into a charger to prevent normal range loss and to keep the Battery at an optimal temperature. Your vehicle is safe to stay plugged in for any length of time.

When not in use, Model Y enters a sleep mode to conserve energy. Reduce the number of times you check your vehicle's status on the mobile app, as this automatically wakes up your vehicle and starts normal energy consumption.



Map Overview

The touchscreen displays a map at all times (except when Model Y is shifted into Reverse).

Use your finger(s) to interact with the map:

- To move the map in any direction, hold and drag a finger.
- To rotate the map in any direction, hold and turn two fingers.
- To zoom the map in or out, expand or pinch two fingers, respectively.

NOTE: When you rotate or move the map, your current location is no longer tracked. The message "Tracking Disabled" displays briefly next to the map orientation icon and the icon turns gray. To re-enable tracking, touch the map's orientation icon and choose North Up or Heading Up.

NOTE: The map zooms in and out automatically when a navigation route is active.

To change the orientation of the map, toggle between these options:



North Up: North is always at the top of the screen.



Heading Up: The direction you are driving is always at the top of the screen. The map rotates as you change direction. This icon has an integrated compass that indicates the direction you are driving.

NOTE: Touching this icon while navigating to a destination displays the route overview.



Route overview is available when you are navigating to a destination and displays when you expand the turn-by-turn direction list (by swiping it downward). When you collapse the turn-by-turn direction list by swiping it upward, the map displays your previously chosen orientation.

Map Display

When Model Y is in Park, the following icons display on the map to allow you to customize the type of information the map displays. To access these icons when driving, touch anywhere on the map (they disappear after a few seconds).



Satellite imagery (if equipped with premium connectivity).



Traffic conditions (if equipped with premium connectivity).



Map details (such as points of interest).

Drop a pin anywhere on the map by pressing and holding your finger on a desired location. When you drop a pin, or touch an existing pin, the chosen location is centered on the map and a popup screen provides information about the location. From this popup, you can navigate to the location add or remove the location from your list of favorite destinations (see [Home, Work, and Favorite Destinations on page 161](#)).



Charging locations. Shows a popup list that includes the city and proximity of the corresponding stations on the map. Charging locations include Tesla Superchargers, destination charging sites, third-party fast chargers, and public chargers that you have used previously. See [Charging Locations on page 162](#). Touch the lightning bolt icons in the popup list to filter by the types of chargers based on max power.

NOTE: In some market regions, third-party fast chargers are also included on the map as dark gray pins when you display chargers.

Navigation Settings

NOTE: The navigation settings available can vary depending on region and vehicle configuration.



The navigation settings icon displays when you touch ... once you start navigating to a destination.

NOTE: You can also access navigation settings by touching **Controls > Navigation**.

Touch the navigation settings icon to customize the navigation system to suit your preferences (the available settings vary depending on your market region and vehicle configuration):

- **Navigation Guidance:** Touch **Voice** to enable an audible reading for navigation instructions.



Maps and Navigation

- Touch **-** or **+** to increase or decrease the volume of spoken navigation instructions. Decreasing all the way to the left or touching the speaker icon mutes the instructions. You can also mute/unmute navigation instructions by touching the speaker icon. This volume setting applies only to the navigation system's spoken instructions. Volume for Media Player and Phone does not change.

NOTE: Volume may automatically be adjusted based on driving speed and climate settings.

NOTE: Navigation instructions are muted when the paired phone has an ongoing phone call.

- Enable **Automatic Navigation** if you want Model Y to automatically initiate a navigation destination when you get in your vehicle. Destinations are predicted based on commonly driven routes, time of day, and calendar entries (see [Automatic Navigation on page 161](#)).
- Enable **Trip Planner** (if available in your market region) to add Supercharger stops as needed. Supercharging stops are added to navigation routes with the goal of minimizing the amount of time you spend driving and charging (see [Trip Planner on page 163](#)).
- Enable **Online Routing** to automatically route to avoid heavy traffic and to get real-time traffic conditions along navigation routes, if available in your region (see [Online Routing on page 163](#)).
- Touch **Avoid Ferries** to be automatically routed to avoid ferries.
- Touch **Avoid Tolls** to be automatically routed to avoid tolls, if possible.

Navigating to a Destination

To navigate to a location, touch the search bar in the corner of the map and enter a destination, send the destination from your phone, or use voice commands (see [Voice Commands on page 14](#)) for an address, landmark, business, etc. If the destination you choose has other destinations within it (such as terminals at an airport), you can also choose a sub-destination.

Touch the search bar for different options:

- Refresh a search when you zoom in or drag to a different area of the map by tapping **Search this area** when prompted (if available in your region).
- Choose a saved **Home** or **Work** location (see [Home, Work, and Favorite Destinations on page 161](#)).
- Select a **Charging** destination (see [Charging Locations on page 162](#)).
- Pick from **Recent** destination (the most recent destination is listed at the top).
- Choose a destination you have marked as a **Favorite** (see [Home, Work, and Favorite Destinations on page 161](#)).

- A popular restaurant when you're feeling **Hungry** or a popular destination (such as museums and amusement parks) when you're feeling **Lucky** (see [Lucky and Hungry on page 161](#)).

NOTE: You can start navigation remotely from your iOS® or Android™ device using the "share" functionality on your device after allowing access to the Tesla mobile app.

When you specify a location, the touchscreen zooms out to provide an overview of the route you need to travel and displays a turn-by-turn direction list. Estimated arrival time, driving time, and mileage displays at the bottom of the direction list. Note the following about the turn-by-turn direction list:

- The Battery icon on the turn list provides a visual representation showing an estimate of how much energy will remain when you reach your destination, and how much will remain if you make a round trip back to your current location. See [Predicting Energy Usage on page 163](#).
- If charging is needed to reach your destination and Trip Planner is enabled (and available in your market region), the navigation route automatically includes Supercharger stops (see [Trip Planner on page 163](#)).
- If you won't have enough energy to reach your destination and there is no Supercharger on the route, an alert tells you that charging is needed to reach your destination.
- Each turn is preceded by the distance to the maneuver.
- To see the bottom of the list, you may need to drag the list upward.
- Touch the top of the list to minimize it.

While navigating, the map tracks your location and displays the current leg of your trip. You can display the entire route at any time by swiping down to expand the turn-by-turn direction list or touching the route overview icon.

Below the turn-by-turn list, a progress bar shows how close you are to your destination or next stop. If online routing is enabled, the progress bar also shows live traffic conditions on your route (see [Online Routing on page 163](#)).

To stop navigating, touch **Cancel**, located in the bottom corner of the turn-by-turn direction list. Swipe right on the suggested location or press and hold the location to quickly delete certain recent navigation searches.

NOTE: If a data connection is not available, onboard maps allow you to navigate to any destination, but you must enter the exact and complete address.



If **Navigate on Autopilot** (if available in your market region) is enabled, you can turn it on for the navigation route by touching **Navigate on Autopilot** in the turn-by-turn direction list (when the feature is active, the icon is blue). **Navigate on Autopilot** automatically changes lanes and steers Model Y on controlled-



access roads (like highways and freeways), along a navigation route. For details, see [Navigate on Autopilot on page 111](#).

Selecting an Alternate Route

Depending on market region and vehicle configuration, this feature may not be available on your vehicle. Your vehicle must be equipped with Premium Connectivity.

After you have entered a destination with one stop, the map displays up to three alternate routes. This allows you to easily compare total travel time and traffic information for each route. If you do not select a preferred route within the timeout period, the fastest route is automatically selected.

Adding Stops to a Route

After entering a destination, edit your route by adding, deleting or reordering stops. Touch the three dots at the bottom of the turn-by-turn direction list to view options to edit your route.



Add Stop allows you to add a stop by searching for a location or adding a Home, Recent or Favorite destination. You can also add a stop by touching any pin on the map and selecting **Add** from the popup.



Edit Stop allows you to set up a complex trip by adding or deleting stops on your route. Drag and drop stops by touching the equal sign to reorder your trip.

You can also use the Tesla mobile app to edit your route (if available in your region). In the Tesla mobile app, go to **Locations > Navigate** and enter a destination, touch **Edit Trip > Add Stop** to edit your route, then touch **Send to Car** to share the trip with your vehicle.

NOTE: Requires Tesla mobile app version 4.27.5 or newer.

Automatic Navigation

NOTE: *Automatic Navigation may not be available in all market regions and on all vehicle configurations.*

Automatic Navigation can predict a destination when you get in your vehicle. When your phone's calendar is synced to Model Y, and the calendar includes an event that takes place within two hours of when you get in your vehicle to drive, Automatic Navigation suggests the location of the event (assuming a valid address is associated with the event).

In addition, if you are Home and drive on weekdays (Monday to Friday) from 5:00 AM to 11:00 AM, Automatic Navigation can automatically route you to your specified Work location (see [Home, Work, and Favorite Destinations on page 161](#)). Likewise, if you are at work on weekdays from 3:00 PM to 11:00 PM, Automatic Navigation can automatically route you to your specified Home location.

To enable Automatic Navigation, touch **Controls > Navigation > Automatic Navigation**. You must have your phone's calendar synced to Model Y and the event must include a uniquely specified and valid address (see [Phone, Calendar, and Web Conferencing on page 69](#)).

NOTE: Navigation instructions that you enter manually, or send to Model Y, override routes suggested by Automatic Navigation.

Lucky and Hungry

NOTE: *Features may not be available in all market regions and on all vehicle configurations.*

In addition to navigating to a destination of your choice, Model Y can also suggest nearby locations based on whether you are feeling **Hungry** or **Lucky**. In the navigation search bar, touch **Hungry** or **Lucky**. **Hungry** suggests a list of popular restaurants, whereas **Lucky** suggests a list of popular destinations (such as museums and amusement parks). Once you discover an interesting destination, touch **Navigate** to proceed to the destination.

This feature requires the latest version of Navigation maps. To download, connect Model Y to Wi-Fi and touch **Controls > Software** to check if an update is available (see [Map Updates on page 164](#)).

Home, Work, and Favorite Destinations

If you frequently drive to a destination, add it as a favorite to avoid entering the location's name or address each time. When you add a destination as a Favorite, you can easily navigate to it by touching the navigation search bar and then touching **Favorites** and choosing it from your list of favorite destinations.



To add a destination to your Favorites list, touch its pin on the map, then touch the star icon on the popup screen that appears. Enter a name (or leave as-is to accept the default name), then touch **Add to Favorites**. The star becomes solid and the destination is included on your Favorites list.

To delete a Recent or Favorite destination, touch it on the destination list and hold it down briefly until the **X** appears. Then touch the **X** to delete it from the list.



Maps and Navigation

Home and **Work** locations also display under the navigation search bar. Touch to set an address to the corresponding location. After entering the address, touch **Save as Home** or **Save as Work**. Then simply touch these shortcuts whenever you want to navigate home or to work.

To change or delete the corresponding address, press and hold the **Home** or **Work** icon. A popup allows you to enter a new address and **Save as Home** or **Save as Work**. Once a Home or Work location is saved, Model Y may prompt you to navigate to your Work location in the mornings and to your Home location in the evenings and provide an estimated driving time based on current traffic conditions. See [Automatic Navigation on page 161](#). Touch **Clear Home** or **Clear Work** to remove associated addresses entirely. Based on your usage patterns, Model Y may prompt you to save a location as Home or Work.

For security reasons, if you sell, transfer ownership, or allow others to drive Model Y, it is recommended that you delete your Home and Work locations. You can delete these individually or you can perform a factory reset to erase all personal data (touch **Controls** > **Service** > **Factory Reset**).

Charging Locations

To display charging locations on the map, touch the map's search bar, then touch **Charging**. Charging locations are shown in a list (with the closest charging location at the top of the list) and represented by corresponding pins on the map. Touch a pin to display more information, navigate to, or mark it as a favorite.

Touch the lightning bolt icons to specify the types of charging locations you want the map to include (by default, the map displays only Superchargers):



Touch to include low power stations up to 70 kW, such as destination charging locations.



Touch to include high power chargers above 70 kW.

NOTE: In some market regions, third-party fast chargers are also included as dark gray pins when you choose to display all charging stations.

The appearance of a charging location's pin reveals the predicted status about the location. Touch the pin to display details.



The Supercharger location is operational and the number displayed on the pin represents the predicted number of available Supercharger stalls upon arrival.

NOTE: A Supercharger located on your current navigation route is colored black (or white, if the touchscreen is in night mode).



The Supercharger location is predicting a high volume of users. You may need to wait before charging.



The Supercharger location may be operating at a reduced capacity.



The Supercharger location may be closed.



The Supercharger location has no data available but should be operational.



The location is either a destination charging location, a third-party fast charger, or a public charging station that you have previously used. Touch to display more information such as usage restrictions and available charge current.

NOTE: When the map is zoomed out and more than one destination charging location is available in an area, the pin is round and displays the number of stations. Touch the pin to zoom in. Then you can touch an individual pin for details about a specific location.

Touch a charging location's pin to display a popup from which you can:

- Determine its exact location and approximate distance from your current location.
- View amenities that are available at the charging location, including restrooms, restaurants, lodging, shopping, and Wi-Fi. On a Supercharger popup, touch an amenity icon to search the surrounding area for the associated amenity.
- Touch the arrow icon to navigate to the charging location.

NOTE: When navigating to a Supercharger (or third-party fast charger in some regions), Model Y preconditions the Battery to prepare for charging. This ensures you arrive with an optimal Battery temperature, reducing the amount of time it takes to charge. In some circumstances (such as cold weather), it is normal for the motor(s) and components to make noise as it generates heat to warm the Battery (see [Charging on page 155](#)).



- View how busy a Supercharger location typically is during different times of the day, along with corresponding charging fees and idle fees (see [Supercharger Fees on page 176](#)).

Predicting Energy Usage

When navigating to a destination, Model Y helps you anticipate your charging needs by calculating the amount of energy that remains when you reach your destination. When navigating, the map displays this calculation next to the Battery icon on the turn-by-turn direction list (see [Navigating to a Destination on page 160](#)). When the turn-by-turn direction list is compressed, touch the top of the list to expand it.

The calculation that predicts how much energy you will use is an estimate based on driving style (predicted speed, etc.) and environmental factors (wind speed and direction, ambient and forecasted temperatures, air density and humidity, etc.). As you drive, Model Y continuously learns how much energy it uses, improving accuracy over time. Model Y predicts energy usage based on the driving style of the individual vehicle. For example, if you drive aggressively for a period of time, future range predictions will assume higher consumption. Some factors that contribute to predicted energy (such as forecasted temperatures and wind speed) are available only when Model Y has internet connectivity.

NOTE: If you purchase a used Tesla vehicle, it is recommended that you perform a factory reset (**Controls > Service > Factory Reset**) to ensure the predicted energy is as accurate as possible.

Throughout your route, Model Y monitors energy usage and updates the estimate of energy remaining at the end of your trip. A popup warning displays on the turn-by-turn direction list in these situations:

- A yellow warning displays when you have very little energy remaining to reach your destination, requiring you to drive slowly to conserve energy. For tips on conserving energy, see [Getting Maximum Range on page 180](#).
- A red warning displays when you must charge to reach your destination.

To determine if you have enough energy for a round trip, touch the Battery icon on the turn-by-turn direction list to display an estimated calculation of your round trip energy usage.

Online Routing

Model Y detects real-time traffic conditions and automatically adjusts the estimated driving and arrival times. In situations where traffic conditions may delay your estimated time of arrival and an alternate route is available, the navigation system can reroute you to your destination. To decline the alternate route, tap the reroute notification on your touchscreen. You can also specify the minimum number

of minutes that must be saved before you are rerouted. Turn this feature on or off by touching **Controls > Navigation > Online Routing**.

If available in your region and **Online Routing** is enabled, real-time traffic condition icons display along navigation routes when detected (Premium Connectivity required).

NOTE: Supported traffic icons vary by region.



Excluding France: Appears when a speed camera is detected. As you are approaching the speed camera, Model Y can also sound a chime. To enable this feature, touch **Controls > Navigation > Speed Camera Chime**.



France only: May or may not contain one or more speed cameras or a range of other driving hazards. As you are approaching the speed camera, Model Y can also sound a chime. To enable this feature, touch **Controls > Navigation > Speed Camera Chime**.



Displays stop signs and traffic lights.



Alerts you of the expected wait time until the traffic light changes.



U.S. only: Appears when there is construction along your route.



Trip Planner

Trip Planner (if available in your region) helps you take longer road trips with confidence. If reaching your destination requires charging, Trip Planner routes you through the appropriate Supercharger locations. Trip Planner selects a route and provides charging times to minimize the amount of time you spend driving and charging. To enable Trip Planner, touch the map's settings icon (see [Navigation Settings on page 159](#)), then touch **Trip Planner**.

When Trip Planner is enabled and charging is required to reach your destination, the turn-by-turn direction list includes Supercharger stops, recommended charging times at each Supercharger, and an estimate of how much energy will be available when you arrive at the Supercharger location.



Maps and Navigation

To remove Supercharger stops and display directions only, touch **Remove all charging stops** at the bottom of the turn-by-turn direction list. If you remove charging stops, the turn-by-turn direction list may display an alert indicating that charging is needed to reach your destination. To add Supercharger stops back to the turn-by-turn direction list, touch **Add charging stops**.

While charging at a Supercharger, the charging screen displays the remaining charging time needed to drive to your next Supercharger stop or destination (if no further charging is needed). If you charge for a shorter or longer length of time, charging time at subsequent Supercharger stops is adjusted accordingly. You can also use the mobile app to monitor remaining charging time needed.

NOTE: When navigating to a Supercharger or, in some regions, a third-party fast charger using Trip Planner, Model Y may allocate some energy to pre-heat the Battery to arrive at the Supercharger or third-party fast charger with an optimal Battery temperature. This reduces charging time (see [Charging on page 155](#)).

If Trip Planner estimates that you won't have enough energy for your round trip, and there are no Superchargers available on your route, Trip Planner displays an alert at the top of the turn-by-turn direction list notifying you that charging is needed to reach your destination.

NOTE: If a Supercharger on your navigation route experiences an outage, Trip Planner displays a notification and attempts to reroute you to a different Supercharger location.

Map Updates

As updated maps become available, they are automatically sent to Model Y over Wi-Fi. To ensure you receive them, periodically connect Model Y to a Wi-Fi network (see [Wi-Fi on page 66](#)). The touchscreen displays a message informing you when new maps are installed.

Overview

NOTE: Media apps vary depending on market region, vehicle configuration, options purchased, and software version. Some apps described may not be available in your market region, or may be replaced by different ones.

The Media Player displays on the touchscreen and is used to play various types of media. You can drag Media Player upward to expand it (allowing you to browse), and downward to minimize it so that just the Miniplayer displays. The convenient Miniplayer, which occupies the least amount of space on the touchscreen, displays what's currently playing and provides only the basic functions associated with what's playing.

Streaming services are available only when a data connection is available (for example, Wi-Fi or Premium Connectivity). For some media services, you can use a default Tesla account. For others, you may need to enter account credentials the first time you use it.

NOTE: Instead of launching a different media app, you can change the source from within the Media Player screen by choosing a source from the dropdown list.



Radio: Choose from a list of available radio stations or touch the numeric keypad to directly tune the radio to a specific frequency. Touch the next or previous arrows to move from one frequency to the next (or previous).

NOTE: Radio stations are sorted alphabetically. You can determine the selection of stations yourself by selecting favorites (see [Recents and Favorites on page 166](#)).



Bluetooth: Play audio from a bluetooth-connected phone or USB device (see [Playing Media from Devices on page 166](#)).

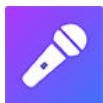

Caraoke (if equipped): Sing along with various songs (see [Caraoke on page 166](#)).

NOTE: You can show or hide any media app/source. See [Media Settings on page 165](#).

Model Y supports these media apps, if available in your region:

- Amazon Music
- Apple Music
- Apple Podcasts
- Audible
- LiveOne
- Spotify
- Tidal
- Tuneln

- YouTube Music

When listening to internet radio or a music streaming service, the options available on the Media Player screen vary depending on what you are listening to. Touch the next (or previous) arrows to play the next (and in some cases previous) available station, episode, or track. You can also play next/previous using the left scroll button on the steering wheel.

NOTE: You can use voice commands to adjust media settings and preferences, such as volume control, playing certain songs, or switching the media source (see [Voice Commands on page 14](#)).

Volume Controls

Volume can be controlled by:

- Roll the scroll button on the left side of the steering wheel up or down to increase or decrease volume respectively. This adjusts the volume for media, voice commands, and phone calls.
- Volume may be adjusted based on your driving speed and climate settings.
- Touch the <> arrows associated with the speaker icon on the bottom corner of the touchscreen.
- To mute the volume, press the left scroll button. Press again to unmute.
- Pressing the left scroll button during a phone call mutes both the sound and your microphone.

Media Settings

NOTE: The settings available vary depending on market region. Also, a setting may not be applicable to all audio sources.



Press the settings icon located in the Media Player's search bar to access audio settings.

You can adjust these settings:

- **Tone:** Drag the sliders to adjust the subwoofer and any of the five frequency bands (Bass, Bass/Mid, Mid, Mid/Treble, and Treble). If equipped with premium audio, you can adjust the level of sound immersion to make your music experience more engaging by dragging the immersive sound slider according to your preferences.
- **Balance:** Drag the center circle to the location in Model Y where you want to focus the sound.
- **Options:** Set preferences for optional features. For example, you can turn **DJ Commentary**, **Explicit Content** and **Allow Mobile Control** on or off.



- **Sources:** Displays all available media sources and allows you to choose whether you want to show or hide each source. You may want to hide media sources that you never use. Once hidden, the media source does not appear on the drop down list in Media Player, nor will it appear in the app tray when you touch the App Launcher. You can re-display a hidden media source at any time by returning to this settings screen.



Your recently played selections are updated continuously so you don't need to remove them.

NOTE: Selections you play on FM (if equipped) radio are not included in the Recents list.

Searching Audio Content



Touch Media Player's magnifying glass icon to search for a particular song, album, artist, podcast, or station. You can also use voice commands to search hands-free (see [Voice Commands on page 14](#)).

Caraoke

NOTE: Depending on vehicle configuration and market region, Caraoke may not be available on your vehicle. Caraoke requires premium connectivity.

Navigate to Media Player and select the drop down menu to change the media source to Caraoke. Or add Caraoke as an app in the app launcher. You can browse through various songs and select the song you want to sing. Touch the microphone icon to enable or disable the song's main vocals. Disabling the microphone leaves only the song's instrumentals and background vocals. Touch the lyrics icon (located next to the microphone icon) to enable or disable the song's lyrics.



WARNING: Never read Caraoke lyrics while driving. You must always pay attention to the road and traffic conditions. When driving, the Caraoke lyrics are intended only for use by a passenger.

Recents and Favorites

For most source content, recents and favorites display at the top for easy access.



To add a currently playing station, podcast, or audio file to your Favorites list, touch the **Favorites** icon on Media Player.



To remove an item as a favorite, touch the highlighted **Favorites** icon. You can also remove multiple favorites by expanding Media Player to show all favorites for the applicable type of source content. Then press and hold any favorite. An **X** appears on all favorites and you can then touch the **X** to remove them from your Favorites list.

Playing Media from Devices

USB Flash Drives

Insert a flash drive into a front USB port (see [USB Ports on page 9](#)). Touch **Media Player** > **USB**, then touch the name of the desired folder. To play media from a USB connection, Model Y recognizes flash drives only. To play media from other types of devices (such as an iPod), you must connect the device using Bluetooth (see [Bluetooth Connected Devices on page 166](#)).

NOTE: Media Player supports USB flash drives with exFAT formatting (NTFS is not currently supported).

NOTE: Use a USB port located at the front of the center console. The USB connections at the rear of the console are for charging only.

NOTE: For some vehicles manufactured after approximately November 1, 2021, the center console USB ports may only support charging devices. Use the USB port inside the glove box for all other functions.

Bluetooth Connected Devices

Pair your Bluetooth-capable device to Model Y (see [Bluetooth on page 67](#)) to play stored audio files. Choose Media Player's **Phone** source, touch the name of your Bluetooth-connected device, then touch **CONNECT**.



Overview

NOTE: Entertainment options may vary depending on market region, date of manufacture, and vehicle configuration.



Theater: Play various video streaming services (such as Netflix, YouTube, Hulu, etc.) while parked. Available only if Model Y is connected to WiFi, or is equipped with premium connectivity and a cellular signal is available.



Arcade: Want to game? You may need to use the steering wheel buttons or a Bluetooth or USB controller to play. See [Gaming Controllers on page 169](#).

NOTE: For some vehicles manufactured after approximately November 1, 2021, the center console USB ports can only be used to charge devices. On these vehicles, you must use the USB port inside the glove box.



Toybox: Play in the Toybox while parked.



WARNING: Use these features only when Model Y is parked. Always pay attention to road and traffic conditions when driving. Using these features while driving is illegal and very dangerous.

NOTE: You can also use voice commands to access these features (see [Voice Commands on page 14](#)).

Toybox

Your vehicle's toybox includes features that can be fun to use. Here's an example of the types of features you can find in Toybox:

Select This...	To Do This...
Boombox	If Model Y is equipped with a Pedestrian Warning System, delight pedestrians with a variety of sounds from your vehicle's external speaker while in Park. See Boombox on page 168 for more details. NOTE: Check local laws before using Boombox in public areas.
Emissions	Fun can come in surprising ways. Select your preferred fart style and target seat. Use your turn signal or press the left scroll wheel when you're ready to "release" your prank. For those lucky vehicles equipped with a Pedestrian Warning System, you can choose to broadcast externally when your vehicle is parked. But wait-- the fun doesn't stop there! Use the mobile app to conduct remote emissions testing by touching and holding any of the four quick control buttons and selecting the fart button.
Light Show	Park outside, turn the volume up, roll down your windows, then enjoy the show. Schedule the light show for a future time and customize the song to surprise your loved ones. NOTE: Light show should not be used when parked on or near public roads. Doing so can be distracting to other road users. Before activating, it is the driver's responsibility to ensure the use of light show complies with local laws and regulations. NOTE: Light show supports multiple custom shows from one USB drive to enjoy and share with others (follow the instructions onscreen).
Mars	The map shows your Model Y as a rover on the Martian landscape, and the About Your Tesla box displays SpaceX's interplanetary spaceship.
Rainbow Charge Port	When Model Y is locked and charging, press the button on the mobile connector ten times in quick succession. Neat, huh?
Rainbow Road	Need more cowbell? Visit Rainbow Road by moving the drive stalk fully down four times in quick succession while Autosteer is enabled.



Theater, Arcade, and Toybox

Romance	You can't roast chestnuts by an open fire in your car, but you can still cozy up with your loved ones by this virtual fireplace. Cue the music and get your romance on!
Sketchpad	Channel your inner Picasso. Show us what you got! Touch Publish to submit your artistic compositions to Tesla for critiquing.
TRAX	It's never too late to follow your dream of becoming a world-famous DJ. With TRAX, you can turn your vehicle into your own personal music studio. While in Park, choose from an array of instruments and unique sounds to create the next hit song. Microphone and headset are not included.
The Answer to the Ultimate Question of Life, The Universe, and Everything	Rename your vehicle to 42 (touch Controls > Software and touch the vehicle's name). Notice the new name.
Car Colorizer	Change the color of your Model Y on the touchscreen. Touch the color swatch next to the vehicle name and customize the exterior color, tone, and more.

Boombox

NOTE: Boombox is available only on vehicles equipped with the Pedestrian Warning System (PWS).

NOTE: Check local laws before using Boombox in public places.

Using Boombox, you can play sound externally through the Pedestrian Warning System (PWS) speaker when Model Y is in Park. For example:

- **Play current media.**
- Use **Megaphone** to project a modulated version of your voice.
- Press the horn to play the first five seconds of any sound from a compatible USB device.

NOTE: If Camp mode is enabled in Climate Controls, you can exit the vehicle and use the Tesla app to control the volume.

Prepare a USB drive for Boombox

Follow these steps to add up to five custom Boombox sounds:

1. On a computer, format a USB drive to exFAT, MS-DOS FAT (for Mac), ext3, or ext4 (NTFS is currently not supported).
2. Create a folder on the USB drive called **Boombox**.

NOTE: The USB drive can only contain one folder. For example, it cannot be shared with Dashcam.

3. Add .wav and .mp3 audio files to the folder. Although you can add as many files as the USB drive's capacity allows, you can only select from the first five, as listed alphabetically. File names, of any length, can contain upper or lower case alpha characters (a-z/A-Z), numbers from 0-9, periods (.), a dashes (-), and underscores (_).

4. Plug the USB drive into a front USB port.

NOTE: For some vehicles manufactured after approximately November 1, 2021, the center console USB ports can only be used to charge devices. On these vehicles, you must use the USB port inside the glove box.

5. Choose a sound from the USB drive by selecting from the **Boombox** dropdown menu.

Uninstall Games

Uninstalling games is useful if you want to free up your vehicle's onboard storage. To uninstall a game, navigate to **Arcade**, select the game you wish to uninstall, then touching **Uninstall**. Once you uninstall a game, you must download it before you can play the game again.



Gaming Controllers

You can pair Bluetooth Classic gaming controllers to Model Y by following the same steps as pairing your phone (see [Phone, Calendar, and Web Conferencing on page 69](#)). After pairing, the controller automatically connects to the vehicle. Once connected, you can use the controller to play select games. Model Y supports up to two Bluetooth devices at a time (such as two controllers, or one phone and one controller).

For vehicles manufactured prior to approximately November 1, 2021, you can connect USB-compatible game controllers to the front USB ports in the vehicle's center console. For vehicles manufactured after approximately November 1, 2021, you must use the glovebox USB port.



Electric Vehicle Components

High Voltage Components

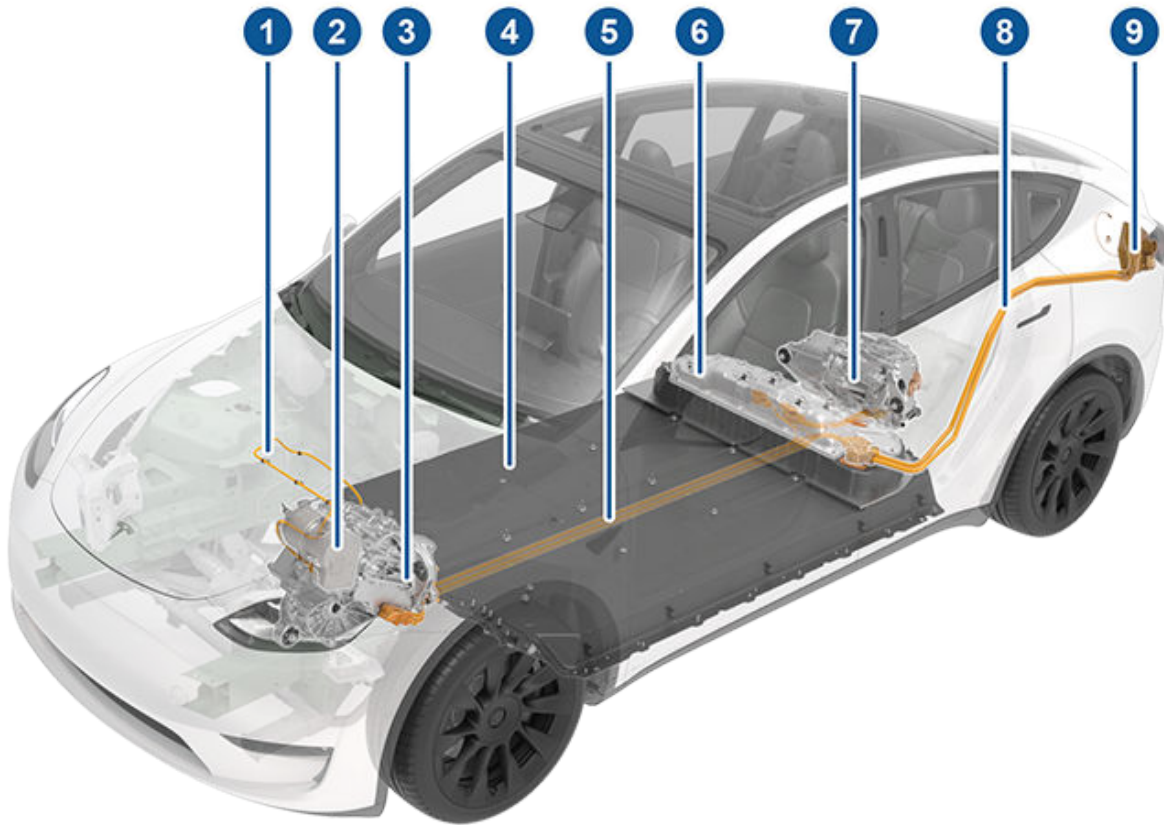

1. High Voltage Cabling
2. Heat Pump Assembly
3. Front Motor (Dual Motor vehicles only)
4. High Voltage Battery
5. High Voltage Cabling
6. Service Access Panel for High Voltage Components (Ancillary Bay)
7. Rear Motor
8. High Voltage Busbars
9. Charge Port

⚠ WARNING: The high voltage system has no user serviceable parts. Do not disassemble, remove or replace high voltage components, cables or connectors. High voltage cables are typically colored orange for easy identification.

⚠ WARNING: Read and follow all instructions provided on the labels that are attached to Model Y. These labels are there for your safety.

⚠ WARNING: In the unlikely event that a fire occurs, immediately contact your local fire emergency responders.

Charging Equipment

Charging equipment designed specifically to charge your Model Y is available from Tesla.

For information on the charging equipment **available for your region**, go to <http://shop.tesla.com>.

- A Wall Connector, which installs in your parking space, is the fastest way to charge your vehicle for daily use.
- A Mobile Connector allows you to plug into most commonly used power outlets. When using the Mobile Connector, attach the smart adapter (if required) to the Mobile Connector before plugging it in to the power outlet, and then plug in your vehicle.



Model Y has one of the most sophisticated battery systems in the world. The most important way to preserve the high voltage Battery is to **LEAVE YOUR VEHICLE PLUGGED IN** when you are not using it. This is particularly important if you are not planning to drive Model Y for several weeks.

NOTE: When left idle and unplugged, your vehicle periodically uses energy from the Battery for system tests and recharging the low voltage battery when necessary.

There is no advantage to waiting until the Battery's level is low before charging. In fact, the Battery performs best when charged regularly.

NOTE: If you allow the Battery to discharge to 0%, other components may become damaged or require replacement (for example, the low voltage battery). In these cases, you are responsible for repair and/or transporting expenses. Discharge-related expenses are not covered by the warranty or under the Roadside Assistance policy.

The peak charging rate of the Battery may decrease slightly after a large number of DC Fast Charging sessions, such as those at Superchargers. To ensure maximum driving range and Battery safety, the Battery charge rate is decreased when the Battery is too cold, the Battery's charge is nearly full, and when the Battery conditions change with usage and age. These changes in the condition of the Battery are driven by battery physics and may increase the total Supercharging duration by a few minutes over time. You can minimize the amount of charge time by using Trip Planner (if available in your market region) to warm the Battery while driving to a Supercharger. See [Trip Planner on page 163](#) for more information.

Battery Care

Never allow the Battery to fully discharge.

Even when Model Y is not being driven, its Battery discharges very slowly to power the onboard electronics. The Battery can discharge at a rate of approximately 1% per day, though the discharge rate may vary depending on environmental factors (such as cold weather), vehicle configuration, and your selected settings on the touchscreen. Situations can arise in which you must leave Model Y unplugged for an extended period of time (for example, at an airport when traveling). In these situations, keep the 1% in mind to ensure that you leave the Battery with a sufficient charge level. For example, over a two week period (14 days), the Battery may discharge by approximately 14%.

Discharging the Battery to 0% may result in damage to vehicle components. To protect against a complete discharge, Model Y enters a low-power consumption mode when the displayed charge level drops to approximately 0%. In this mode, the Battery stops supporting the onboard electronics and auxiliary low voltage battery. Once this low-power consumption mode is active, immediately plug in Model Y to prevent a jump start and low voltage battery replacement.

NOTE: If Model Y is unresponsive and does not unlock, open, or charge, the low voltage battery may be discharged. In this situation, try jump starting the low voltage battery (see [Jump Starting on page 223](#)). If the vehicle is still unresponsive, use the mobile app to schedule a service appointment.

Temperature Limits

For better long-term performance, avoid exposing Model Y to ambient temperatures above 60° C or below -30° C for more than 24 hours at a time.

Energy Saving Feature

Model Y has an energy-saving feature that reduces the amount of energy being consumed by the displays when Model Y is not in use. On newer vehicles, this feature is automated to provide an optimal level of energy saving. However, on older vehicles, you can control the amount of energy being consumed by the displays by touching **Controls > Display > Energy Saving**. For more information on maximizing range and saving energy, see [Getting Maximum Range on page 180](#).

Submerged Vehicle

As with any vehicle, if your Tesla has been exposed to flooding, extreme weather events or has otherwise been submerged in water (especially in salt water), treat it as if it's been in an accident and contact your insurance company for support. Do not attempt to operate the vehicle before Tesla Service has inspected it, but you should tow or move it away from any structures.

NOTE: Damage caused by water is not covered under warranty.

Battery Warnings and Cautions

 **WARNING:** The high voltage system must be serviced **only** by a trained technician. Under no circumstances should you open or tamper with the Battery. Do not disassemble, remove or replace high voltage components, cables or connectors. High voltage cables are typically colored orange for easy identification.

 **CAUTION:** If the Battery's charge level falls to 0%, you must plug it in. If you leave it unplugged for an extended period, it may not be possible to charge or use Model Y without jump starting or replacing the low voltage battery. Leaving Model Y unplugged for an extended period can also result in permanent Battery damage. If you are unable to charge Model Y after attempting to jump start the low voltage battery, schedule a service appointment.

 **CAUTION:** The Battery requires no owner maintenance. Do not remove the coolant filler cap and do not add fluid. If the touchscreen warns you that the fluid level is low, use the mobile app to schedule a service appointment.



High Voltage Battery Information



CAUTION: Do not use the Battery as a stationary power source. Doing so voids the warranty.



Opening the Charge Port

The charge port is located on the left side of Model Y, behind a door that is part of the rear tail light assembly. Park Model Y to ensure that the charge cable easily reaches the charge port.

With Model Y in Park, press and release the button on the Tesla charge cable to open the charge port door.



You can also open the charge port door using any of these methods:

- On the touchscreen, touch **Controls** and touch the Charge Port icon (lightning bolt).
- On the touchscreen, navigate to **Controls > Charging > Open Charge Port**.
- Press the bottom of the charge port door when Model Y is unlocked and an authenticated phone is nearby.
- On the key fob accessory (sold separately), hold down the rear trunk button for 1-2 seconds.
- When the vehicle is locked with an authenticated key in range, you can also press the button on the charge cable to open the charge port door (see [Keys on page 18](#)).
- Use voice commands to open the charge port door (see [Voice Commands on page 14](#)). You can also use voice commands to close the charge port door, and begin or stop charging.

NOTE: The following image is provided for demonstration purposes only. Depending on market region and date of manufacture, your charge port may be slightly different.



NOTE: The Tesla "T" lights up when you open the charge port door. If you do not insert a charge cable into the charge port within a few minutes after opening the charge port door, the charge port door closes. If this happens, use the touchscreen to open the charge port door again.

NOTE: In extremely cold weather or icy conditions, it is possible that your charge port latch may freeze in place. Some vehicles are equipped with a charge port inlet heater that turns on when you turn on the rear defrost in cold weather conditions. You can also thaw ice on the charge port latch by enabling preconditioning using the mobile app. To prevent this from occurring, use the **Schedule** settings (also available on both the charging and climate control screens), to set a time when you want your vehicle to be ready to drive (see [Scheduled Precondition and Charge on page 178](#)).



CAUTION: Do not try to force the charge port door open.

Plugging In

If desired, use the touchscreen to change the charge limit and the charging current (see [Charge Settings on page 175](#)).

To charge at a public charging station, plug the appropriate adapter into the vehicle's charging port, and then connect the station's charging connector to the adapter. The most commonly used adapter(s) for each market region are provided. Depending on the charging equipment you are using, you may need to start and stop charging using a control on the charging equipment.

If you are using the Mobile Connector, plug into the power outlet before plugging in Model Y.

Align the connector to the charge port and insert fully. When the connector is properly inserted, charging begins automatically after Model Y:

- Engages a latch that holds the connector in place;
- Shifts into Park (if it was in any other drive mode);
- Heats or cools the Battery, if needed. If the Battery requires heating or cooling, you may notice a delay before charging begins.



Charging Instructions

NOTE: Whenever Model Y is plugged in but not actively charging, it draws energy from the charging equipment instead of using energy stored in the Battery. For example, if you are sitting in Model Y and using the touchscreen while parked and plugged in, Model Y draws energy from the charging equipment instead of the Battery.

In some cases when Model Y is plugged in but using very little energy, however, it may draw it directly from the Battery. For example, if you leave Model Y plugged in for several days without using it, it may gradually draw a small amount of energy directly from the Battery to support vehicle systems.

Once the Battery discharges enough, it starts charging to reach the limit again. Depending on when you check, the Battery may not have discharged enough yet to trigger a charge cycle. As a result, it may be slightly under the charge limit even after being plugged in for a long period. This is normal, and Model Y will start charging again once it has discharged enough. Alternatively, to start a new charge cycle manually, unplug and then plug in Model Y.



CAUTION: The connector end of the charge cable can damage the paint if you drop it onto Model Y.

Charge Port Light

After you insert a charge cable into Model Y, wait a few seconds and confirm that the charge port light begins blinking green and that your vehicle is charging. If the light is amber or red, troubleshoot the issue before you leave to ensure a successful charging session.

- **WHITE (OR LIGHT BLUE):** The charge port door is open. Model Y is ready to charge and the connector is not inserted, or the charge port latch is unlocked and the connector is ready to be removed.
- **BLUE:** The charger is connected, but Model Y is not charging (such as when scheduled charging is active).
- **BLINKING BLUE:** Model Y is communicating with the charger, but has not started charging yet (such as when your vehicle is preparing to charge).
- **BLINKING GREEN:** Charging is in progress. As Model Y approaches a full charge, the frequency of the blinking slows.
- **SOLID GREEN:** Charging is complete.
- **SOLID AMBER:** The connector is not fully plugged in. Realign the connector to the charge port and insert fully.
- **BLINKING AMBER:** Model Y is charging at a reduced current (AC charging only).
- **RED:** A fault is detected and charging has stopped. Check the touchscreen for an alert.

Charging Status

Charging status displays at the top of the car status screen when the charge port door is open.

1. **Time remaining:** The estimated time remaining to charge to your set limit (see [Charge Settings on page 175](#)).

NOTE: When charging to 100%, the vehicle may continue to charge with low power when charging is displayed as complete. This is expected operation. Because the added energy beyond this point is low, it is usually not beneficial to continue charging.

2. **Charging:** The current power of the charger.
3. **Charging rate:** The maximum current available from the attached charge cable.
4. **Range gained:** Estimated increase in driving distance achieved in the charging session.

5. **Driving distance:** Displays the total estimated driving distance or energy percentage (depending on your display setting) available.

NOTE: To change how energy units are displayed, touch **Controls > Display > Energy Display**.

6. **Charge status:** Charge status messages (such as Supercharging, Scheduled Charging) display here (see [Scheduled Precondition and Charge on page 178](#)).

During Charging

During charging, the charge port light (the Tesla "T" logo) pulses green, and the touchscreen displays real-time charging status. The frequency at which the green charge port light pulses slows down as the charge level approaches full. When charging is complete, the light stops pulsing and is solid green.

NOTE: If Model Y is locked, the charge port light does not light up.

If the charge port light turns red while charging, a fault is detected. Check the touchscreen for an alert describing the fault. A fault can occur due to something as common as a power outage. If a power outage occurs, charging resumes automatically when power is restored.

NOTE: The thermal system may produce steam under certain conditions for vehicles with heat pumps (to determine if your vehicle has a heat pump, touch **Controls > Software > Additional Vehicle Information**). For example, odorless steam can come from the front of your vehicle while charging at a Supercharger in cold temperature. This is normal and not a cause for concern.

NOTE: It is normal to hear sounds during charging. Particularly at high currents, the refrigerant compressor and fan operate as needed to keep the Battery cool.

NOTE: Air conditioning performance is generally not affected by charging. However, in some circumstances (for example, charging at high currents during a particularly warm day), the air coming from the vents may not be as cool as expected and a message displays on the touchscreen. This is normal and ensures that the Battery stays within an optimum temperature range while charging to support longevity and optimum performance.



⚠ WARNING: Never spray liquid at a high velocity (for example, a pressure washer) towards the charge port while charging. Doing so can result in serious injury or damage to the vehicle, charging equipment, or property.

Stopping Charging

Stop charging at any time by disconnecting the charge cable or touching **Stop Charging** on the touchscreen.

NOTE: To prevent unauthorized unplugging of the charge cable, the charge cable latch remains locked and Model Y must be unlocked or able to recognize your key before you can disconnect the charge cable.

To disconnect the charge cable:

1. Press and hold the button on the connector handle to release the latch.
NOTE: You can also release the latch using the lightning icon on the car status overview on the touchscreen or mobile app, or by pressing and holding the rear trunk button on the key fob.
2. Pull the connector from the charge port. The charge port door automatically closes.

NOTE: You can also close the charge port door using any of these methods:

- On the touchscreen, touch the Charge Port icon (lightning bolt) on the car status overview.
- On the touchscreen, navigate to **Controls > Charging > Close Charge Port**.
- Use voice commands to close the charge port door (see [Voice Commands on page 14](#)).

⚠ CAUTION: Never close the charge port door manually. Doing so can cause damage.

To disconnect the charge cable when using an adapter at a public charge station:

1. Unlock Model Y.
2. While holding the public charging handle in one hand and the adapter in the other hand, press and hold the button on the public charging handle and pull both outwards, removing the handle and adapter at the same time.
NOTE: If the charging station handle separates from the adapter, leaving the adapter in Model Y, use the touchscreen to unlock the charge port.
3. Press and hold the button on the charging handle again to release the adapter from the public charging handle.

NOTE: The charge port door automatically closes within approximately 10 seconds of removing the connector from the charge port.

NOTE: You can also close the charge port door using any of these methods:

- On the touchscreen, touch the Charge Port icon (lightning bolt) on the car status overview.
- On the touchscreen, navigate to **Controls > Charging > Close Charge Port**.
- Use voice commands to close the charge port door (see [Voice Commands on page 14](#)).

⚠ CAUTION: Never close the charge port door manually. Doing so can cause damage.

⚠ CAUTION: Tesla strongly recommends leaving Model Y plugged in when not in use. This maintains the Battery at the optimum level of charge.

⚠ CAUTION: Model Y does not shift out of Park if the charge port is unable to determine whether a charging cable is plugged in. Ensure the charging cable is unplugged and follow the instructions on the touchscreen to proceed (see [Park on page 79](#)).

Charge Settings

Access charge settings by touching **Controls > Charging** when Model Y is in Park. You can also touch the battery icon on the touchscreen to access charge settings.

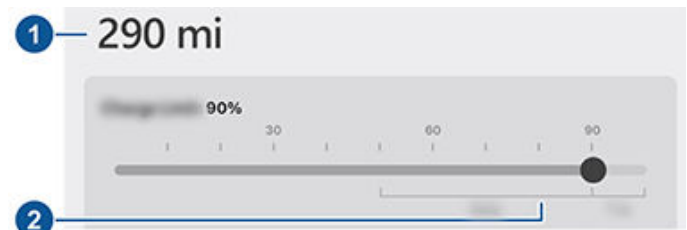

1. **Driving distance:** Displays the total estimated driving distance available.
2. **Set limit:** Adjust the charge slider to the level of charging you want. The setting you choose applies to immediate and scheduled charging sessions.

NOTE: Refer to the information on the vehicle touchscreen (navigate to **Controls > Charging**) or the mobile App (touch the **Charging** icon) for recommended daily and trip charging limits.

NOTE: A portion of the battery image may appear blue. This indicates that a small portion of the energy stored in the battery is not available because the battery is cold. This is normal and no reason for concern. When the battery warms up, the blue portion no longer displays.

Slide the charge limit past the daily recommended charge limit for a pop-up option to temporarily charge above the daily recommended limit for one-time only. This is helpful for long trips and, if selected, resets back to the previous charge limit.



Charging Instructions

You can further adjust charge settings:

- **Charge current at this location:** The current automatically sets to the maximum current available from the attached charge cable, unless it was previously reduced to a lower level. If needed, touch **-** or **+** to change the current (for example, you may want to reduce the current if you are concerned about overloading a domestic wiring circuit shared by other equipment). It is not possible to set the charging current to a level that exceeds the maximum available from the attached charge cable. When you change the current, Model Y remembers the location. If you charge at the same location, you do not need to change it again.

When charging using the Mobile Connector with domestic outlets, your vehicle may automatically select a default charge current. Override this default current to a higher setting by customizing **Charge Current at this location** or through the mobile app.

- **Open Charge Port, Unlock Charge Port and Stop Charging:** When not charging, touch **Open Charge Port** or **Unlock Charge Port** to open the charge port door or to unlock the charge cable from the charge port. You can also touch the lightning icon near the charge port on the car status overview. Use **Stop Charging** when you are finished charging.
- **Schedule:** Displays the precondition and charging schedule. You can create a precondition or charge schedule for your saved home and work locations, or your current location (see [Scheduled Precondition and Charge on page 178](#)).
- **Charge on Solar at this location:** *If available in your region*, setup your vehicle with your Tesla Powerwall to charge from excess solar production, using the Tesla mobile app. When your vehicle is plugged in at home and **Charge on Solar** is enabled, your vehicle charges up to the minimum charge limit from any source and then continues charging on only excess solar power up to the maximum charge limit. If a scheduled charge or precondition is configured, your vehicle uses any excess solar and waits until the designated time to charge from any source to the minimum charge limit. *System requirements outside of North America: Vehicle software 2023.32 or higher, Powerwall software 23.12.10 or higher and Tesla mobile app 4.30.5 or higher.*
- **Supercharging:** Displays Supercharger usage fees, the location, the time that charging started, and a cost estimate for the session (see [Supercharger Fees on page 176](#)).

NOTE: To reduce congestion at high-usage Supercharger sites, you may be limited to a maximum charge of 80% when not using Trip Planner (if available in your market region). See [Trip Planner on page 163](#)).

Supercharger Fees

When charging at a Tesla Supercharger, information about the charging session displays at the bottom of the charging screen. This includes the location, the time that charging started, and a cost estimate for the session. When you stop Supercharging, the estimated cost of the session displays until a new Supercharging session begins.

NOTE: Estimated cost may not reflect the final cost of the Supercharging session. Final pricing for Supercharging sessions can be found in your Tesla account.

When charging at a Tesla supercharger, you are subject to idle fees. Idle fees are designed to encourage drivers to move their vehicle from the Supercharger when charging is complete. Idle fees are in effect only when half or more of the Superchargers at a site are occupied. The Tesla mobile app notifies you when charging is almost complete, and again when charging is complete. Additional notifications are sent if idle fees are incurred. Idle fees are waived if you move your vehicle within five minutes of when charging completed.

Log into your Tesla account to view fees and details about Supercharger sessions, set up a payment method, and make payments. Once a payment method is saved, fees are automatically paid from your account.

Manually Releasing Charge Cable

If the usual methods for releasing a charge cable from the charge port (using the charge handle release button, touchscreen, or mobile app) do not work, try pressing and holding down the rear trunk button on the key fob accessory (if equipped) for 1-2 seconds. If it still doesn't release, carefully follow these steps:

1. Ensure that Model Y is not actively charging by displaying the charging screen on the touchscreen. If necessary, touch **Stop Charging**.
2. Open the rear trunk.
3. Pull the charge port's release cable downwards to unlatch the charge cable.



WARNING: Do not pull the release cable while simultaneously attempting to remove the charge cable from the charge port. Always pull the release cable *before* attempting to remove the charge cable. Failure to follow these instructions can result in electric shock and serious injury.



NOTE: The release cable may be recessed within the opening of the trim.

4. Pull the charge cable from the charge port.

CAUTION: Use the release cable **only** in situations where you can not release the charge cable using the usual methods. Continuous use can damage the release cable or charging equipment.

WARNING: Do not perform this procedure when your vehicle is charging, or if any orange high voltage conductors are exposed. Failure to follow these instructions can result in electric shock and serious injury or damage to the vehicle. If you are uncertain as to how to safely perform this procedure, contact your nearest Service Center.

Charging Best Practices

- Avoid allowing the Battery to get too low (the Battery icon turns yellow when the capacity remaining in the Battery drops to 20% or below).
- Refer to the information on the vehicle touchscreen (navigate to **Controls** > **Charging**) or the mobile App (touch the **Charging** icon) for recommended daily and trip charging limits.
- After you plug in your vehicle, confirm that the charge port light begins blinking green (indicating that Model Y is charging) before you walk away. If Model Y does not begin charging after a few seconds, the connector may not be fully inserted into the charge port, or there may be an issue preventing charging. Check the touchscreen for an alert with more information.

NOTE: If the charge port light begins blinking amber, Model Y is charging at a reduced current. If the charge port light is solid blue, the charger is connected but the vehicle is not charging (such as when a charge is scheduled). For more information, see [Charge Port Light on page 174](#).

Fast charging tips:

- Find fast chargers by filtering for three lightning bolts in the navigation search bar.



Scheduled Precondition and Charge

Schedule preconditioning and charging for Model Y. You can schedule preconditioning to help your vehicle charge more efficiently, or to prepare Model Y for departure.

NOTE: You can also access **Schedule** from the Climate Controls screen, the Charging window, and the Tesla mobile app (v4.34.5 or higher required).

Model Y automatically saves your schedule for each location you create a schedule at. When you select **Current Location**, the configured schedule can only be used when you return to the same approximate physical location.

NOTE: Scheduled charge cannot be used with fast chargers, including Tesla Superchargers. Charging schedules you create are ignored when you charge at a fast charger.

Create a Schedule

Create a **Precondition** and **Charge** schedule to specify the time and days you want Model Y to precondition or charge. To create a schedule:

1. Touch **Controls** > **Schedule**.
2. Select the location for which you want to configure a schedule.
 - **Current Location:** The current location of your car, based on your GPS coordinates.

NOTE: You must be parked to create a schedule for your current location.
 - **Home/Work:** The saved location for your home and workplace. You can't choose these options if you don't have a saved home or work (see [Home, Work, and Favorite Destinations on page 161](#)).
3. Touch **Precondition** to configure the time and the frequency you want the vehicle to precondition by.
4. Touch **Charge** to configure the time you want to start and stop, and the frequency you want to charge.
5. Select **Create** to create the schedule.

NOTE: If **Repeat Weekly** is not toggled, Model Y performs the schedule once. The vehicle then disables the schedule until you manually re-enable the schedule.

Using Scheduled Charging

When you create or enable a scheduled charge, you can plug in your vehicle for a charge. If you scheduled a precondition or charge for later in the day, Model Y waits until that time to precondition or charge.

When your schedules overlap, the vehicle uses the largest block of time for charging, if necessary. Example: You scheduled Model Y to start charging at 2 AM and at 3 AM, but to stop charging at 2:30 AM and 5 AM, the vehicle combines the two charge schedules into a single block from 2 AM to 5 AM.

When you specify an **End by** time, but not a **Start at** time, the vehicle briefly draws power when plugging in for scheduled charging (you may hear clicking) to calculate the necessary start time to meet your charge limit. Example: You configure an **End by** time of 2 AM and the vehicle needs 2 hours to charge to meet the charge limit. If you plug in your vehicle at 9 PM, Model Y briefly draws power to calculate the start time and begins charging at 12 AM.

If you specify a **Start at** time and no **End by** time, the vehicle begins charging at the specified time and continues until your charge limit is reached.

There are scenarios where **Scheduled Charging** starts immediately. These scenarios can occur when Model Y is plugged in:

- During a scheduled charge.
- Up to 6 hours after the start of a scheduled charge, if there is no specified **End by** time.
- When the next scheduled charge is more than 18 hours away and not the current day.
- When you haven't configured a **Start at** time and there is not enough time to reach the charge limit by the **End by** time.

NOTE: Model Y does NOT automatically start charging if you plug in your vehicle within 6 hours after the **End by** time of a scheduled charge, unless there is another scheduled charge.

You can schedule your charge to finish right at a planned departure time to reduce energy costs, even in market regions where off-peak utility rates are not applicable. Example, if charging starts as soon as you plug in, charging may complete much sooner. This causes the Battery to cool down to ambient temperatures and requires energy to warm it back up by your departure time. Therefore, even if off-peak utility rates are not applicable to you, Tesla recommends that you charge until your planned departure time in order to reduce energy consumption by specifying your departure time as the scheduled **End by** time.

Preconditioning

Use **Precondition** to schedule a time when you want Model Y to be ready to drive. Model Y automatically calculates when it needs to start preconditioning. This ensures that the cabin climate and Battery are preconditioned by your departure time.

Precondition warms the Battery for improved performance and ensures a comfortable cabin climate at your set departure time. If you don't schedule a **Precondition**, Model Y only warms the Battery before charging if the Battery is too cold to charge, and doesn't prepare the cabin climate.

NOTE: When Model Y is not plugged in, preconditioning operates but only when the Battery's charge level is above 20%.



Preconditioning can also help to increase range on your next trip because a preconditioned cabin and battery consumes less energy when you begin driving. Preconditioning can reduce energy consumption while driving in vehicles with heat pumps, because heat in the battery can be used to warm the cabin while driving.



Factors Affecting Energy Consumption

While driving:

- Elevated driving speed.
- Environmental conditions such as cold or hot weather and wind.
- Using climate controls to heat or cool the cabin.
- Uphill travel: Driving uphill requires more energy and depletes range at a faster rate. However, driving downhill allows your vehicle to regain a portion of its expended energy through regenerative braking (see [Regenerative Braking on page 86](#)).
- Short trips or stop-and-go traffic: It takes energy to bring the cabin and Battery to a specified temperature when starting the vehicle. You may see a higher average consumption when the vehicle is used for very short trips or in heavy traffic.
- Heavy cargo load.
- Windows rolled down.
- Wheels and tires not maintained.
- Customized settings or third-party accessories (roof or trunk racks, third party wheels).

While parked and not plugged in to a charger:

- Preconditioning the cabin or using climate controls.
- Summon.
- Vehicle infotainment and climate controls system.
- Sentry mode.
- Tesla or third-party mobile app requests.

Tips to Maximize Range

You can maximize your driving range using the same driving habits you use to conserve fuel in a gasoline-powered vehicle. To achieve maximum range:

- Slow down your driving and avoid frequent and rapid acceleration. Consider using Chill Mode (touch **Controls > Dynamics > Acceleration**) and Speed Assist (see [Speed Assist on page 140](#)) to assist in controlling your acceleration and speed.
- If safe to do so, modulate the accelerator pedal instead of using the brake pedal when gradually slowing down. Whenever Model Y is moving and you are not pressing the accelerator pedal, regenerative braking slows down the vehicle and feeds surplus energy back to the Battery (see [Regenerative Braking on page 86](#)).
- Limit the use of resources such as heating and air conditioning. Using seat and steering wheel heaters (if equipped) to keep warm is more efficient than heating the cabin using climate controls.

- With your vehicle plugged in, use the mobile app to precondition your vehicle to ensure the cabin is at a comfortable temperature and windows are defrosted (if needed) before your drive by touching **Climate > On** and customizing your preferences (see [Mobile App on page 64](#)).
- Touch **Schedule**, (also available on both the charging and climate control screens) to set a time when you want your vehicle to be ready to drive (see [Scheduled Precondition and Charge on page 178](#)).
- Set Stopping Mode to **Hold** to gain the benefit of regenerative braking at low driving speeds (see [Stopping Mode on page 87](#)).
- Ensure the wheels are aligned to specification, the tires are kept at the recommended inflation pressures (see [Tire Care and Maintenance on page 185](#)), and are rotated when needed (see [Maintenance Service Intervals on page 183](#)).
- Install aero covers (if equipped) to reduce wind resistance (see [Removing and Installing Aero Covers on page 187](#)).
- Lighten your load by removing any unnecessary cargo.
- Fully raise all windows.
- Features such as Sentry Mode and Cabin Overheat Protection can impact range. Disable features when not needed.
- To prevent an excessive amount of energy consumption while the vehicle is idle, keep the vehicle plugged in when not in use.

It is normal for estimated range to decrease slightly over the first few months before leveling off. Over time, you may see a gradual, but natural, decrease in range at full charge – this depends on factors such as the mileage and age of the Battery. Your Model Y will inform you in the unlikely event a hardware issue is causing excessive Battery or range degradation.

The power meter on the touchscreen provides feedback on energy usage.

Range Assurance

The driving range displayed in Model Y is an estimate of the remaining battery energy based on EPA-rated consumption. It may not account for your personal driving patterns or external conditions. The displayed range on the touchscreen may decrease faster than the actual distance driven. To view estimated range based on your recent energy consumption, open the Energy app to display the graph.

NOTE: Rated driving range is based on EPA-rated consumption in the United States, which deviates from tests advertised and performed in other jurisdictions.

Your vehicle continuously monitors its energy level and proximity to known charging locations.



Touch **Chargers** in the Navigation search bar to toggle between types of chargers, including Superchargers and destination charging sites.

When you are at risk of driving beyond the range of known charging locations, the touchscreen displays a message giving you the opportunity to display a list of charging locations that are within range. When you select a charging location from the list, Model Y provides navigation instructions and the turn-by-turn direction list displays the predicted amount of energy that will remain when you arrive at the charging destination.

Trip Planner (if available in your market region) routes you through Supercharger locations to minimize the amount of time you spend charging and driving. To enable, touch **Controls > Navigation > Trip Planner**.

Energy App

The Energy app provides a visual representation of your vehicle's real-time and projected energy usage.



1. Locate the Energy app in the bottom bar by touching the app launcher (the three dots).
2. Touch to open the Energy app and choose from the different tabs. The energy chart's colored line represents your actual driving energy consumption whereas the gray line represents predicted usage.

NOTE: You can customize the chart values by touching **Controls > Display > Energy Display**.

- **Drive:** Monitor the amount of energy being used while driving. You can track the real-time energy consumption broken down by categories, compare against different baseline projections, and view range tips tailored to your drive to understand how to improve energy efficiency.
 1. Choose **Trip** while navigating to a destination to compare the actual usage against the estimated projection.
 2. Choose **Rated** to compare the actual energy or range usage against the estimated driving distance (or energy) available.
 3. Choose between **Current Drive** to view data from your current drive or **Since Last Charged** to include data since the vehicle was last charged.
 4. View **Range Tips** to understand impacts on battery consumption and suggestions to maximize range and efficiency.
- **Park:** Monitors the amount of energy lost while Model Y is parked.

1. Choose between **Since Last Drive** or **Since Last Charge**.
 2. View how much idle energy has been consumed while your vehicle is parked and suggestions to decrease energy loss.
- **Consumption:** Display how much energy Model Y has consumed over the past 10, 25 or 50 km.
 1. Touch **Instant Range** to adjust the projected range estimation. Instant Range uses only the latest few data points to estimate the projected range.
 2. Touch **Average Range** to use the past 10, 25 or 50 km of energy consumption to provide a more accurate projected range.



Loading New Software

Tesla updates your vehicle's software wirelessly, constantly providing new features. Tesla recommends you install software updates at the earliest opportunity on your vehicle. To ensure the fastest and most reliable delivery of software updates, leave Wi-Fi turned on and connected whenever possible. In most cases, your vehicle must be connected to Wi-Fi to download the software update (see [Wi-Fi on page 66](#)).

Downloading vs. Installing New Software

There are two steps to receiving a new update: downloading the software (which requires Wi-Fi), and installing it. For your convenience, you can start downloads and installations using the Tesla mobile app.

Download

When a software update is available for download, the download occurs automatically, showing a green arrow at the top of the touchscreen. If the vehicle is not connected to Wi-Fi, a yellow download icon appears. Although you can drive while the software update is being downloaded, doing so can interrupt the download if your vehicle loses the Wi-Fi connection. When the software update is fully downloaded and ready to install, a clock icon displays at the top of the touchscreen.

NOTE: To ensure the fastest and most reliable download of software updates, leave the Wi-Fi turned on and connected whenever possible (see [Wi-Fi on page 66](#)).

Install

You CANNOT drive while software is being installed. If plugged in, your vehicle will stop charging until the installation is complete. To start the installation, touch the yellow clock icon at the top of the touchscreen. Touch **Install Now** to begin the installation immediately or touch **Set For This Time** to choose a different start time. At any time before the update installs, you can touch this clock icon to reschedule. If you are driving Model Y at the scheduled update time, the update is canceled and must be rescheduled. You can also view, download, and install software updates by navigating to **Controls > Software**. If available, connect to Wi-Fi to download the update.

Software updates are not performed when certain features are active, such as Keep Climate On, Dog Mode, or Camp Mode.

NOTE: Software updates will not install if Keep, Dog, or Camp mode are enabled (see [Keep Climate On, Dog, and Camp on page 151](#)).

NOTE: On an as-needed basis, Tesla also sends software updates using a cellular connection.

NOTE: Some software updates take approximately 30 minutes to complete (some may take longer). Model Y must be in Park while the software is being updated.



WARNING: Do not attempt to use the vehicle while the software is being installed. Vehicle functions, including some safety systems and opening or closing the doors or windows, may be limited or disabled when installation is in progress and you could damage the vehicle.

Software Update Preferences

Tesla determines how, when, and where to send updates to vehicles based on various factors unique to each release. In **Controls > Software**, you can choose how quickly you want to receive updates that are ready for your vehicle. Be an early adopter by selecting **Advanced** (which will have additional releases), or wait until others have installed (which will result in fewer releases) by selecting **Standard**. Choosing **Advanced** does not enroll your vehicle in Tesla's early access program.

Tesla does not update your software upon request for those wanting to receive the latest features and improvements. Selecting **Advanced** and consistently connecting to Wi-Fi (see [Wi-Fi on page 66](#)) is the best way to quickly receive the latest software updates.

If the touchscreen displays a message indicating that a software update was not successfully completed, wait for the next software update to deploy to your vehicle.

NOTE: The software update screen persists until you install the update. Install a software update as soon as possible. Any harm resulting from failure to install a software update is not covered by the vehicle's warranty. Failure or refusal to install updates can cause some vehicle features to become inaccessible or digital media devices may become incompatible.

NOTE: Tesla may update or reinstall your vehicle's software as part of the normal diagnostic, repair, and maintenance process within Tesla Service.

NOTE: Reverting to a previous software version is not possible.

Charging

If Model Y is charging when the software update begins, charging stops. Charging resumes automatically when the software update is complete.

Viewing Release Notes

When a software update is complete, read the release notes displayed on the touchscreen to learn about changes or new features. To display release notes about the current version of your vehicle's software at any time, touch **Controls > Software > Release Notes**.

Tesla strongly recommends reading all release notes. They may contain important safety information or operating instructions for your Model Y.



Service Intervals

Tesla recommends the following maintenance items and intervals, as applicable to your vehicle, to ensure continued reliability and efficiency of your Model Y.

For additional information on vehicle alerts, see [Troubleshooting Alerts on page 226](#).

- Brake fluid health check every 4 years (replace if necessary)*.
- A/C desiccant bag replacement every 4 years.
- Cabin air filter replacement every 2 years.
- HEPA filter (x2) and carbon filter (x2) replacement every 3 years.
- Clean and lubricate brake calipers every year or 12,500 miles (20,000 km) if in an area where roads are salted during winter.
- Rotate tires every 10,000 km or if tread depth difference is 1.5 mm or greater, whichever comes first.

*Heavy brake usage due to towing, mountain descents, or performance driving -- especially for vehicles in hot and humid environments -- may necessitate more frequent brake fluid checks and replacements.

NOTE: Any damage caused by opening the Battery coolant reservoir is excluded from the warranty.

NOTE: The above intervals are based on typical driving behaviors and scenarios. Depending on various circumstances such as driving behavior, usage, environmental conditions, etc., the above maintenance items may need to be performed more or less frequently than specified. Additionally, the above list should not be considered comprehensive and does not include consumable parts such as windshield wipers, brake pads, low voltage battery, etc.

NOTE: Damages or failures caused by maintenance or repairs performed by non-Tesla certified technicians are not covered by the warranty.

For more do-it-yourself maintenance procedures and information, see <https://www.tesla.com/support/do-it-yourself-guides>.

Schedule Service

Scheduling a service visit through the mobile app is easy. After touching **Service**, select the type of service needed and follow the directions in the mobile app. Provide as much detail as possible to better help the Service team identify the cause of concern, such as:

- Photos, sound recordings, or videos.
- Date(s), time(s), and time zone when the issue occurred.
- Country of use and location.

- Approximate speed the vehicle was traveling (if applicable).
- Environmental conditions (rain, snow, cold, etc.).
- Road name and type of road (if applicable).
- Quality of lane markings (if applicable).
- Applicable vehicle settings.
- Identifiable symptoms.

Visit <https://www.tesla.com/support/service-visits> for more information on scheduling service.

Daily Checks

- Check the Battery's charge level, displayed on the touchscreen or mobile app.
- Check the condition and pressure of each tire (see [Tire Care and Maintenance on page 185](#)).
- Check that all exterior lights, horn, turn signals, and wipers and washers are working.
- Check for any unexpected indicator lights or vehicle alerts on the touchscreen.
- Check the operation of the brakes, including the parking brake.

NOTE: Because Model Y uses regenerative braking (see [Regenerative Braking on page 86](#)), the brake pads are typically used less frequently than those in traditional braking systems. To avoid the accumulation of rust and corrosion, Tesla recommends frequently pressing the brake pedal to apply the mechanical brakes, which dries the brake pads and rotors.

- Check the operation of the seat belts (see [Seat Belts on page 35](#)).
- Look for abnormal fluid deposits underneath Model Y that might indicate a leak. It is normal for a small pool of water to form (caused by the air conditioning system's dehumidifying process).
- Look around the exterior of Model Y and immediately remove any corrosive substances (such as bird droppings, tree resin, tar spots, dead insects, industrial fallout, etc.) to prevent damage to the exterior (see [Cleaning on page 192](#)).

Weekly Checks

- During wet weather, clean Autopilot cameras weekly (see [Cleaning a Camera on page 192](#)). Otherwise, clean them monthly during dry weather.

Monthly Checks

- Check windshield washer fluid level and top up if necessary (see [Topping Up Windshield Washer Fluid on page 196](#)).



Maintenance Service Intervals

- Check that the air conditioning system is operating correctly (see [Operating Climate Controls on page 149](#)).

NOTE: In addition to cooling the interior, the air conditioning compressor also cools the Battery. Therefore, in hot weather, the air conditioning compressor can turn on even if you turned it off. This is normal because the system's priority is to cool the Battery to ensure it stays within an optimum temperature range to support longevity and optimum performance. Also, even when not in use, you may hear Model Y emit a whining noise or the sound of water circulating. These sounds are normal and occur when the internal cooling systems turn on to support various vehicle functions, such as maintaining the low voltage battery and balancing the temperature of the high voltage Battery.

Periodic Checks

Perform the following checks as needed:

Over time, when driving in dusty or polluted conditions, your vehicle's radiator may become clogged. This can affect air flow and heating/AC performance. To clean, do it yourself by navigating to the [Service Manual](#). Alternatively, use the mobile app to schedule a service appointment.

Fluid Replacement Intervals

Battery coolant and brake fluid levels should only be checked by Tesla or a professional automotive repair shop. Specific service information is available in the Service Manual.

- **Battery coolant:** Your Battery coolant does not need to be replaced for the life of your vehicle under most circumstances.

NOTE: Any damage caused by opening the Battery coolant reservoir is excluded from the warranty.

- **Brake fluid:** Do not top up your brake fluid.

Software

Updating software is important to ensure proper operation and longevity of your vehicle's components. You must install a software update at the earliest opportunity. See [Software Updates on page 182](#).

Tesla may update or reinstall your vehicle's software as part of the normal diagnostic, repair, and maintenance process within Service.

High Voltage Safety

Your Model Y has been designed and built with safety as a priority. However, be aware of these precautions to protect yourself from the risk of injury inherent in all high-voltage systems:

- Read and follow all instructions provided on the labels that are attached to Model Y. These labels are there for your safety.
- The high voltage system has no user-serviceable parts. Do not disassemble, remove or replace high voltage components, cables or connectors. High voltage cables are colored orange for easy identification.
- If a collision occurs, do not touch any high voltage wiring, connectors, or components connected to the wiring.
- In the unlikely event that a fire occurs, immediately contact your local fire emergency responders.



WARNING: Always disconnect the charge cable before working underneath Model Y, even if charging is not in progress.



WARNING: Keep your hands and clothing away from cooling fans. Some fans operate even when Model Y is powered off.



WARNING: Some fluids (Battery acid, Battery coolant, brake fluid, windshield washer additives, etc.) used in vehicles are poisonous and should not be inhaled, swallowed, or brought into contact with open wounds. For your safety, always read and follow instructions printed on fluid containers.



Displaying Tire Pressures

Tire pressures display on the touchscreen in the cards area on the car status display, or by touching **Controls > Service**. The pressure of each tire displays in the visualization of your Model Y, in addition to what time your tire pressures were last measured. The touchscreen also displays your vehicle's recommended cold tire pressures so you can easily determine how much to inflate your tires. You can choose whether you want to display tire pressures using Bar or PSI by touching **Controls > Display > Tire Pressure**.

You can also view tire pressures in the Tesla mobile app.

NOTE: You may need to drive briefly before the visualization displays the tire pressure values.

Maintaining Tire Pressures

Keep tires inflated to the pressures shown on the Tire Information label, even if it differs from the pressure printed on the tire itself. The Tire and Loading Information label is located on the center door pillar and is visible when the driver door is open.



The Tire Pressure indicator light on the touchscreen alerts you if one or more tires is under-inflated.

The Tire Pressure indicator light does not immediately turn off when you adjust tire pressure. After inflating the tire to the recommended pressure, you must drive over 25 km/h for a short amount of time to activate the Tire Pressure Monitoring System (TPMS), which turns off the Tire Pressure indicator light.

If the indicator light flashes for one minute whenever you power on Model Y, a fault with the TPMS is detected (see [TPMS Malfunction on page 189](#)).

NOTE: Your vehicle's tire pressures will drop in cold ambient temperatures. If the TPMS indicator light appears, inflate the tires before driving. The tires will lose one PSI for every 6° C drop in outside temperature. Proper tire pressures help protect tires from potholes and improve range when properly inflated.



WARNING: Under-inflation is the most common cause of tire failures and can cause a tire to overheat, resulting in severe tire cracking, tread separation, or blowout, resulting in unexpected loss of vehicle control and increased risk of injury. Under-inflation also reduces the vehicle's range and tire tread life.



WARNING: The Low Tire Pressure indicator light alerts you only in situations when a tire is below the recommended threshold (as indicated on the Tire and Loading Information label) under normal driving conditions. It does not alert you when a tire is under-inflated based on the load you are carrying.



WARNING: Check tire pressures using an accurate pressure gauge when tires are cold. It takes only about 1.6 kms of driving to warm up the tires sufficiently to affect tire pressures. Parking the vehicle in direct sunlight or in hot weather can also affect tire pressures. If you must check warm tires, expect increased pressures. Do not let air out of warm tires in an attempt to match recommended cold tire pressures. A hot tire at or below the recommended cold tire inflation pressure is dangerously under-inflated.

Checking and Adjusting Tire Pressures

Follow these steps when tires are cold and Model Y has been stationary for over three hours:

1. Refer to the Tire Information label located on the driver's center door pillar for the target tire pressure.
2. Remove the valve cap.
3. Firmly press an accurate tire pressure gauge onto the valve to measure pressure.
4. If required, add or remove air to reach the recommended pressure.

NOTE: You can release air by pressing the metal stem in the center of the valve.

5. Re-check pressure using the accurate tire gauge.
6. Repeat steps 3 and 4 as necessary until the tire pressure is correct.
7. Reinstall the valve cap to prevent dirt from entering. Periodically check the valve for damage and leaks.

Inspecting and Maintaining Tires

Regularly inspect the tread and side walls for any sign of distortion (bulges), foreign objects, cuts or wear.



Tire Care and Maintenance

⚠ WARNING: Do not drive Model Y if a tire is damaged, excessively worn, or inflated to an incorrect pressure. Check tires regularly for wear, and ensure there are no cuts, bulges or exposure of the ply/cord structure.

Tire Wear

Adequate tread depth is important for proper tire performance. Tires with a tread depth less than 3 mm are more likely to hydroplane in wet conditions and should not be used. Tires with a tread depth less than 4 mm do not perform well in snow and slush and should not be used when driving in winter conditions.

Model Y is originally fitted with tires that have wear indicators molded into the tread pattern. When the tread has been worn down to 3 mm, the indicators start to appear at the surface of the tread pattern, producing the effect of a continuous band of rubber across the width of the tire. For optimal performance and safety, Tesla recommends replacing tires before the wear indicators are visible.

To improve vehicle handling characteristics and minimize hydroplaning in wet conditions, put tires with the most tread on the rear of the car.

Tire Rotation, Balance, and Wheel Alignment

Tesla recommends rotating the tires every 10,000 km or if tread depth difference is 1.5 mm or greater, whichever comes first.

Tire rotation is an essential part of tire maintenance. It helps maintain an even treadwear pattern which enhances the tire's overall wear quality, decreases road noise and maximizes tire life.

Vehicles with staggered wheels and non-directional tires can be rotated side-to-side (left-to-right) but not front-to-back as the front and rear tire size is different. Left-to-right rotation can increase tread life by changing the direction of rotation for each tire and balancing shoulder wear.

Unbalanced wheels (sometimes noticeable as vibration through the steering wheel) affect vehicle handling and tire life. Even with regular use, wheels can get out of balance. Therefore, they should be balanced as required.

If tire wear is uneven (on one side of the tire only) or becomes abnormally excessive, check the wheel alignment. If the tires need to be serviced, such as rotated or replaced, reset the tire configuration (see [Tire Configuration on page 189](#)) to improve your driving experience.

Punctured Tires

A puncture eventually causes the tire to lose pressure, which is why it is important to check tire pressures frequently. Permanently repair or replace punctured or damaged tires as soon as possible.

Your tubeless tires may not leak when penetrated, provided the object remains in the tire. If, however, you feel a sudden vibration or ride disturbance while driving, or you suspect a tire is damaged, immediately reduce your speed. Drive slowly, while avoiding heavy braking or sharp steering and, when safe to do so, stop the vehicle. Arrange to have Model Y transported to a Tesla Service Center, or to a nearby tire repair center.

NOTE: In some cases, you can temporarily repair small tire punctures (under 6 mm) using an optional tire repair kit available from Tesla. This allows you to slowly drive Model Y to Tesla or to a nearby tire repair facility.

⚠ WARNING: Do not drive with a punctured tire that has not been repaired, even if the puncture has not caused the tire to deflate. A punctured tire can deflate suddenly at any time.

Flat Spots

If Model Y is stationary for a long period, tires can form flat spots. When Model Y is driven, these flat spots cause a vibration which gradually disappears as the tires warm up and regain their original shape.

To minimize flat spots during storage, inflate tires to the maximum pressure indicated on the tire wall. Then, before driving, release air to adjust tire pressure to the recommended levels.

Improving Tire Mileage

To improve the mileage you get from your tires, maintain tires at the recommended tire pressures, observe speed limits and advisory speeds, and avoid:

- Pulling away quickly, or hard acceleration.
- Fast turns and heavy braking.
- Potholes and objects in the road.
- Hitting curbs when parking.
- Contaminating tires with fluids that can cause damage.

Replacing Tires and Wheels

Tires degrade over time due to the effects of ultraviolet light, extreme temperatures, high loads, and environmental conditions. It is recommended that tires are replaced every six years, or sooner if required, even if tread depth is above the minimum.

If tires need to be replaced early, for example due to a flat tire, we recommend replacing the tires in pairs unless the other tires are within 1.5 mm of tread depth of the new tire. When replacing tires, it is important to match the brand and model of the older tires. Always place a pair of new tires on the rear if all four tires are the same size. Always balance the wheel and tire after replacing a tire. Consult with a professional tire retailer and installer for further guidance. If you replace your tires or install different ones, reset the tire



configuration (see [Tire Configuration on page 189](#)). This resets the learned tire settings and improves the driving experience on your new tires. It may take up to 24 hours after a tire replacement or repair before the tire lubricant is completely dry and tires achieve maximum adherence to the rims. Avoid hard accelerations during this period to avoid tire slip on the rim.

NOTE: Regardless of the number of tires replaced, a complete set of matching tires is recommended for optimum performance.

If tires other than those specified are used, ensure that the load and speed ratings marked on the tire (see [Understanding Tire Markings on page 215](#)) equal or exceed those of the original specification.

For the specification of the original wheels and tires installed on Model Y, see [Wheels and Tires on page 214](#).

If you replace a wheel, the TPMS (Tire Pressure Monitoring System) sensors need to be reset to ensure they provide accurate warnings when tires are under-inflated (see [Automatic Reset of TPMS Sensors on page 189](#)).

NOTE: Installing winter tires with aggressive compound and tread design may result in temporarily-reduced regenerative braking power. However, your vehicle is designed to continuously recalibrate itself, and after changing tires it will increasingly restore regenerative braking power after some moderate-torque straight-line accelerations. For most drivers this occurs after a short period of normal driving, but drivers who normally accelerate lightly may need to use slightly harder accelerations while the recalibration is in progress. Go to **Service > Wheel & Tire > Tires** to select winter tires and quicken this process.

WARNING: For your safety, use only tires and wheels that match the original specification. Tires that do not match the original specification can affect the operation of the TPMS.

WARNING: Never exceed the speed rating of your vehicle's tires. The speed rating is shown on the sidewall of your tires (see [Understanding Tire Markings on page 215](#)).

Asymmetric Tires

Some Model Y tires are asymmetric and must be mounted on the wheel with the correct sidewall facing outward. The sidewall of the tire is marked with the word **OUTSIDE**. When new tires are installed, make sure that the tires are correctly mounted on the wheels.



WARNING: Road holding is seriously impaired if the tires are incorrectly installed on the wheels.

Removing and Installing Aero Covers

If your Model Y is equipped with aero covers, you must remove them to access the lug nuts.

To remove an aero cover:

1. Grasp the aero cover firmly with both hands.
2. Pull the aero cover toward you to release the retaining clips.



To install an aero cover:

1. Align the aero cover with the valve stem.
2. Firmly press the center of the cover to secure it in place, then work your way out to firmly pressing the outer perimeter of each spoke. You may need to hold onto the opposite side of the cover until all spokes are secured.
3. Firmly press the center of the cap with your hands (do not hit the cover with your hands) to ensure it is secured.
4. As a final check, quickly pull each spoke to confirm they are secured in place.



Tire Care and Maintenance



⚠ CAUTION: To prevent the aero cover from falling off, ensure that it is fully secured before driving.

Removing and Installing Lug Nut Covers

If your Model Y is equipped with lug nut covers, you must remove them to access the lug nuts.

To remove a lug nut cover:

1. Place the curved part of the lug nut cover tool (located in the glovebox for some vehicles, or you can use a small allen wrench) into the lowered perimeter around the middle of the lug nut cover.

NOTE: The lug nut cover tool can also be purchased at an auto parts store or through online retailers.



2. Twist the lug nut cover tool so that the end of the curved part is facing away from the Tesla "T".
3. Firmly pull the lug nut tool away from the wheel until the lug nut cover is released.

To install the lug nut cover:

1. Align the lug nut cover into position.
2. Push firmly on the lug nut cover until it fully snaps into place.

⚠ CAUTION: Make sure the lug nut cover is fully secure before driving to prevent it from falling off.

Wheel Configuration

If you are installing new wheels or swapping them for different ones, update your vehicle's wheel configuration by touching **Controls > Service > Wheel & Tire > Wheels**. This allows Model Y to learn the new wheels and provide more accurate status updates on your vehicle. Select a wheel from the drop down menu that matches the new wheels you plan to install on Model Y. Selecting new wheels in the wheel configuration also changes the wheels that appear on your vehicle's avatar on the touchscreen.

Ensure you are aware if your vehicle is equipped with staggered wheels, meaning the wheels are different sizes in the front and rear. Check the front and rear tire sizes marked on the tire sidewall to see if they match or are different sizes. If the wheels are staggered, take extra precaution to ensure the new wheels you install are staggered in the same way as the previous wheels.

NOTE: Changing your vehicle's wheel configuration can impact range estimates, tire pressure warning levels, and vehicle visualization.

⚠ WARNING: Only use Tesla-approved wheels when installing or swapping wheels. Using non Tesla-approved wheels can cause serious damage. Tesla is not liable for damage caused by using wheels not approved by Tesla.



Tire Configuration

To see the miles driven since your last tire rotation or replacement, touch **Controls** > **Service** and look under Last Tire Service. After the tires on Model Y are rotated, replaced, or swapped, update your vehicle's tire configuration by touching **Reset**, or by touching **Wheel & Tire** > **Tires** from the same screen. This allows your vehicle to reset the learned tire settings and improve your driving experience. This also clears and resets the tread wear alert for the vehicle until you travel (10,000 km) and low tread depth is detected again.

Ensure you are aware if your vehicle is equipped with winter tires. Winter tires can be identified by a mountain and snowflake icon on the tires' sidewall. See [Winter Tires on page 190](#) for more information.

NOTE: Changing your vehicle's tire configuration can temporarily impact acceleration and regenerative braking levels and should only be done after tires have been rotated or replaced.

Tire Pressure Monitoring



The Model Y is equipped with a tire pressure monitoring system that warns the driver of significant under-inflation or over-inflation of the tires by displaying the Tire Pressure Indicator Light. Check the Tire Information label located on the driver's door pillar for more details, or see [Maintaining Tire Pressures on page 185](#).

Each tire, including the spare (if provided), should be checked monthly when cold and inflated to the inflation pressure recommended by the vehicle manufacturer on the vehicle placard or tire inflation pressure label. (If your vehicle has tires of a different size than the size indicated on the vehicle placard or tire inflation pressure label, you should determine the proper tire inflation pressure for those tires.)

As an added safety feature, your vehicle has been equipped with a tire pressure monitoring system (TPMS) that illuminates a low tire pressure telltale when one or more of your tires is significantly under-inflated. Accordingly, when the low tire pressure telltale illuminates, you should stop and check your tires as soon as possible, and inflate them to the proper pressure. Driving on a significantly under-inflated tire causes the tire to overheat and can lead to tire failure. Under-inflation also reduces fuel efficiency and tire tread life, and may affect the vehicle's handling and stopping ability.

Please note that the TPMS is not a substitute for proper tire maintenance, and it is the driver's responsibility to maintain correct tire pressure, even if under-inflation has not reached the level to trigger illumination of the TPMS low tire pressure telltale.

TPMS Malfunction

Your vehicle has also been equipped with a TPMS malfunction indicator to indicate when the system is not operating properly. The TPMS malfunction indicator is combined with the low tire pressure telltale. When the system detects a malfunction, the telltale will flash for approximately one minute and then remain continuously illuminated. This sequence will continue upon subsequent vehicle start-ups as long as the malfunction exists.

When the malfunction indicator is illuminated, the system may not be able to detect or signal low tire pressure as intended. TPMS malfunctions may occur for a variety of reasons, including the installation of replacement or alternate tires or wheels on the vehicle that prevent the TPMS from functioning properly. Always check the TPMS malfunction telltale after replacing one or more tires or wheels on your vehicle to ensure that the replacement or alternate tires and wheels allow the TPMS to continue to function properly.



The TPMS malfunction indicator is combined with the tire pressure indicator light. If Model Y detects a fault with the TPMS, this indicator flashes for one minute whenever you power on Model Y.

NOTE: If a tire has been replaced or repaired using a different tire sealant than the one available from Tesla, and a low tire pressure is detected, it is possible that the tire sensor has been damaged.

NOTE: Installing accessories that are not approved by Tesla can interfere with the TPMS.



CAUTION: Avoid placing powered USB devices near the card reader on the center console (see [#unique_533 on page](#)) as powered USB devices may interfere with the tire pressure monitoring system.

Automatic Reset of TPMS Sensors

After replacing one or more wheels (but not after replacing a tire), the TPMS sensors are relearned to ensure tire pressure warnings are accurate. TPMS sensors reset automatically within two minutes of driving over 25 km/h.



WARNING: If your Model Y is equipped with aftermarket tires that differ in size from those printed on the Tire Information Label, it is the driver's responsibility to determine the correct tire pressure. Do not drive on public roads when tires are not inflated to the correct pressure.



WARNING: Do not depend on TPMS sensors to accurately determine pressures and trigger alerts. It is the driver's responsibility to maintain correct tire pressures (see [Maintaining Tire Pressures on page 185](#)). Over or under-inflated tires can result in loss of control or tire damage, which can lead to serious injury.



Tire Care and Maintenance

Replacing a Tire Sensor

If the Tire Pressure warning indicator displays frequently, use the mobile app to schedule a service appointment to determine if a tire sensor needs to be replaced. If a non-Tesla Service Center repairs or replaces a tire, the tire sensor may not work until Tesla performs the setup procedure.

Seasonal Tire Types

Understand Your Tire Type

The type of tires that your vehicle is originally equipped with depends on vehicle model and market region. It is important to understand the capabilities of your vehicle's tires and whether they are suited for summer, all-season, or winter driving. Check the information on the sidewall of a tire for information about a tire's performance characteristics (see [Understanding Tire Markings on page 215](#)).

Summer and All-Season Tires

Summer tires and all season tires are designed for maximum dry and wet road performance but are not designed to perform well in winter conditions. All-season tires are designed to provide adequate traction in most conditions year-round, but may not provide the same level of traction as winter tires in snowy or icy conditions. All-season tires can be identified by "ALL SEASON" and/or "M+S" (mud and snow) on the tire sidewall.

If driving in cold temperatures or on roads where snow or ice may be present, Tesla recommends using winter tires.

WARNING: In cold temperatures or on snow or ice, summer and all-season tires do not provide adequate traction. Selecting and installing the appropriate tires for winter conditions is important to ensure the safety and optimum performance of your Model Y.

Winter Tires

Use winter tires to increase traction in snowy or icy conditions. When installing winter tires, always install a complete set of four tires at the same time. Winter tires must be the same diameter, brand, construction and tread pattern on all four wheels.



Winter tires can be identified by a mountain/snowflake symbol on the tire's sidewall.

When driving with winter tires, you may experience more road noise, shorter tread life, and less traction on dry roads.

NOTE: Installing winter tires with aggressive compound and tread design may result in temporarily-reduced regenerative braking power. However, your vehicle is designed to recalibrate itself to restore regenerative braking power after a short period of normal driving.

NOTE: If you install winter tires or replace your tires, reset the tire configuration by navigating to **Controls > Service > Wheel & Tire Configuration > Tires** (see [Tire Configuration on page 189](#)). This resets the learned tire settings and improves the driving experience on your new tires.

WARNING: Never exceed the speed rating of your vehicle's tires. The speed rating is shown on the sidewall of your tires (see [Understanding Tire Markings on page 215](#)).

Driving in Low Temperatures

Tire performance is reduced in low ambient temperatures, resulting in reduced grip and an increased susceptibility to damage from impacts. Performance tires (summer applications) have reduced traction in ambient temperatures below 5° C, and are not recommended in snow/ice conditions. Performance tires can temporarily harden when cold, causing you to hear rotational noise for the first few kilometers until the tires warm up.

Using Tire Chains

Tesla has tested and approved the following tire chains (also called snow chains) to increase traction in snowy conditions. Tire chains should only be installed on the rear tires. The approved tire chains can be purchased from Tesla.

Tire Size	Recommended Chain
19"/20"	König XG-12 Pro size 252
21"	König K-Summit XXL K66

CAUTION: If your Model Y is equipped with aero covers, you must remove them before installing tire chains (see [Removing and Installing Aero Covers on page 187](#)). Failure to do so can cause damage not covered by the warranty.

CAUTION: Do not put tire chains on summer tires. Doing so can cause damage.

When installing tire chains, follow the instructions and warnings provided by the tire chain manufacturer. Mount them evenly and as tight as possible.

When using tire chains:

- Inspect the tire chains for loose fittings and damaged links before each use.
- Avoid heavily loading Model Y (heavy loads can reduce the clearance between the tires and the body).
- Do not drive the vehicle without the chains properly installed.
- Drive slowly. Do not exceed 48 km/h.



- Remove the tire chains as soon as conditions allow.

NOTE: Tire chains are prohibited in some jurisdictions. Check local laws before installing tire chains.



CAUTION: Using non-recommended tire chains, or using tire chains on other sized tires can damage the suspension, body, wheels, and/or brake lines. Damage caused by using non-recommended tire chains, or incorrectly installing tire chains, is not covered by the warranty.



CAUTION: Do not use snow chains on the front tires.



CAUTION: Never deflate your tires to put on tire chains. When re-inflated, the chains might fit too tightly and cause tire damage.



CAUTION: Ensure that the tire chains cannot touch suspension components or brake lines. If you hear the chains making unusual noises that would indicate contact with Model Y, stop and investigate immediately.



Cleaning the Exterior

To prevent damage to the paint, immediately remove corrosive substances (grease, oil, bird droppings, tree resin, dead insects, tar spots, road salt, industrial fallout, etc.). Do not wait until Model Y is due for a complete wash. If necessary, use denatured alcohol to remove tar spots and stubborn grease stains, then immediately wash the area with water and a mild, non-detergent soap to remove the alcohol.

Keep the exterior cameras free of dirt, condensation, or obstructions. These substances can cause unclear pictures or Autopilot and safety features to stop working (see [Cleaning a Camera on page 192](#)).

Follow these steps when washing the exterior of Model Y:

1. Before washing, flush grime and grit from the vehicle using a hose. Flush away accumulations of mud in areas where debris easily collects (such as wheel wells and panel seams). If salt has been used on the highways (such as during winter months), thoroughly rinse all traces of road salt from the underside of the vehicle, wheel wells, and brakes.
2. Hand wash Model Y using a clean soft cloth and cold or lukewarm water and a mild, high-quality car shampoo.

 **CAUTION:** Some cleaners and car shampoos contain chemicals that can cause damage or discoloration, especially for plastic trim pieces, exterior lights, or camera lenses. For example, some car cleaning formulas contain hydroxide or other highly alkaline or caustic ingredients that can damage exterior components. Do not use acidic products either. Damage or discoloration resulting from cleaning products is not covered by the warranty.

3. After washing, rinse with clean water to prevent soap from drying on the surfaces.
4. Dry thoroughly with a chamois. If necessary, dry the brakes by going on a short drive and applying the brakes multiple times.

Use isopropyl alcohol wipes (such as those used to clean glasses or screens) to clean away small stains.

Window Cleaning and Treatments

Clean windows and mirrors using an automotive glass cleaner. Do not scrape or use any abrasive cleaning fluid on glass or mirrored surfaces. Follow the directions in [Cleaning the Exterior on page 192](#) for best practices in cleaning the exterior glass.

To add a hydrophobic coating to your vehicle's windows, apply the coating only to the side and rear windows, not the front windshield—doing so may affect the visibility of the autopilot cameras. Follow the hydrophobic coating manufacturer's instructions for application details.

NOTE: Tesla is not responsible for any damage associated with applying window treatments on your vehicle.

Car Wash Mode

When taking Model Y to a car wash, Car Wash Mode closes all windows, locks the charge port, and disables windshield wipers, Sentry Mode, walk-away door locking, and parking sensor chimes. To enable, touch **Controls > Service > Car Wash Mode**. Your vehicle must be stationary and not actively charging.

If using an automatic car wash, **Enable Free Roll** keeps your vehicle in Neutral and activates free roll for the duration of the wash, while preventing Model Y from applying the Parking brake if you leave the driver's seat. To enable, press on the brake pedal and touch **Enable Free Roll**; or shift into Neutral.

Car Wash Mode disables if the vehicle's speed exceeds 15 km/h or by touching **Exit** on the touchscreen.



CAUTION: Failure to put Model Y in Car Wash Mode may result in damage (for example, to the charge port or windshield wipers). Damage caused by car washes is not covered by the warranty.

Cleaning a Camera

To ensure a clear picture, the camera lens must be clean and free of obstructions. There are different methods to clean a camera, depending on when your vehicle was built.

For vehicles built from Gigafactory Shanghai prior to approximately mid-February 2024: Remove any build-up of dirt or debris by spraying water onto the camera lens with a spray bottle. Do not attempt to remove dirt or debris by wiping an exposed lens with your hands or a cloth. This debris can damage the surface of the lens when rubbed against it during wiping.

For vehicles built from Gigafactory Shanghai as of approximately mid-February 2024: Remove any build-up of dirt or debris by spraying water onto the camera lens and drying it with a microfiber cloth. Clean the camera lens every week during wet weather (snow, rain, sleet) and every month during dry weather.



CAUTION: Do not use chemical-based or abrasive cleaners. Doing so can damage the surface of the lens.



CAUTION: Do not clean an ultrasonic sensor (if equipped) or camera lens with a sharp or abrasive object that can scratch or damage its surface.











Cautions for Exterior Cleaning



CAUTION: Do not wash in direct sunlight.



CAUTION: Do not use windshield treatment fluids. Doing so can interfere with wiper friction and cause a chattering sound.

-  **CAUTION:** Do not use hot water, detergents, highly alkaline or caustic cleaning ingredients or solvents, specifically those containing hydroxide.
-  **CAUTION:** If using a pressure washer, maintain a distance of at least 30 cm between the nozzle and the surface of Model Y. Avoid aiming the water jet directly at parking sensors (if equipped). Keep the nozzle moving and do not concentrate the water jet on any one area.
-  **CAUTION:** Do not aim water hoses directly at windows, door, or hood seals or at electronic modules or exposed cabling.
-  **CAUTION:** To avoid corrosive damage that may not be covered by the warranty, rinse away any road salt from the underside of the vehicle, wheel wells, and brakes. After cleaning the vehicle, dry the brakes by going on a short drive and applying the brakes multiple times.
-  **CAUTION:** Avoid using tight-napped or rough cloths, such as washing mitts. A high-quality microfiber cleaning cloth is recommended.
-  **CAUTION:** If washing in an automatic car wash, use touchless car washes only. These car washes have no parts (brushes, etc.) that touch the surfaces of Model Y. Some touchless car washes use caustic solutions that, over time, can cause discoloration of decorative exterior trim. Avoid exposure to soaps and chemicals above pH 13. If unsure, check the product label or ask the staff at the car wash. Damage caused by improper washing is not covered by the warranty.
-  **CAUTION:** If washing in an automatic car wash, make sure the vehicle is locked. In addition, avoid using controls on the touchscreen that can result in accidentally opening doors or trunks while the vehicle is being washed. Any damage caused is not covered by the warranty.
-  **CAUTION:** Ensure the wipers are off before washing Model Y to avoid the risk of damaging the wipers.
-  **CAUTION:** Do not use chemical based wheel cleaners or pre-wash products. These can damage the finish on the wheels.
-  **WARNING:** Never spray liquid at a high velocity (for example, if using a pressure washer) towards the charge port while Model Y is charging. Failure to follow these instructions can result in serious injury or damage to the vehicle, charging equipment, or property.

Cleaning the Interior

Frequently inspect and clean the interior to maintain its appearance and to prevent premature wear. If possible, immediately wipe up spills and remove marks. For general cleaning, wipe interior surfaces using a soft cloth (such as microfiber) dampened with a mixture of warm water and mild non-detergent cleaner (test all cleaners on a concealed area before use). To avoid streaks, dry immediately with a soft lint-free cloth.

Interior Glass

Do not scrape, or use any abrasive cleaning fluid on glass or mirrored surfaces. This can damage the reflective surface of the mirror and the heating elements in the rear window.

Airbags

Do not allow any substance to enter an airbag cover. This could affect correct operation.

Dashboard and Plastic Surfaces

Do not polish the upper surfaces of the dashboard. Polished surfaces are reflective and could interfere with your driving view.

Interior Lighting

NOTE: The Tesla warranty does not cover damage caused by improper maintenance, including the use of cleaning solutions or tools that are not recommended in this Owner's Manual.

Do not use any soap or chemical cleaning solutions on interior lighting. Common cleaning solutions and substances can degrade the lenses or components of the lighting, causing cracks and damage over time. When you want to clean interior lighting, Tesla recommends that you use a soft cloth moistened with warm water to gently wipe away soiled areas or stains. Interior lighting includes, but is not limited to, these lights (if equipped):

- Footwell
- Puddle
- Projection
- Dome
- Ambient

When you want to clean the interior with soap or a mild non-detergent cleaner, Tesla recommends that you first cover all lighting with some form of protection, such as:

- Fabric.
- Masking tape.
- Plastic film.
- Protective covers for car interiors.

Seats

NOTE: The Tesla warranty does not cover damage caused by improper maintenance, including the use of cleaning solutions or tools that are not recommended in this Owner's Manual.



Cleaning

Your vehicle's seats are made of a custom, sustainable, vegan leather which is softer than leather, yet far more durable and stain resistant. Tesla recommends that you regularly clean and vacuum the interior of your vehicle to maintain performance and an as-new appearance. You can purchase an all-purpose cleaning kit on the [Tesla Shop](#).

Avoid contact with harsh chemicals, including certain cosmetics. Such substances can cause damage, degradation, or discoloration over time.

For general spills and stains, wipe spills and chemical residues from interior surfaces as soon as possible. Moisten a soft cloth (preferably microfiber) with warm water and mild soap and gently wipe the stain in a circular motion. Then, wipe dry using a soft, lint-free cloth. Do not blow dry. Anything more than soap can be too harsh. Using other cleaning agents, disinfectants, conditioners, or protectants is not recommended.

For white seats: As a last resort, moisten a soft cloth (such as microfiber) with warm water and isopropyl alcohol and gently wipe the stain in a circular motion (DO NOT use this method on black seats). Clean off any remaining isopropyl alcohol residue with a soft, damp cloth. Aggressive or extended use of isopropyl alcohol will damage the top coat of the material, allowing stains to occur more readily and violating the warranty.

 **CAUTION:** Do not use products containing alcohol, bleach (sodium hypochlorite), citrus, naphtha, or silicon-based additives. Do not spray the seat directly with any spray. Do not get water into the seat belt mechanism.

A variety of clothing, accessories, and cosmetics may contain dyes or oils which can transfer onto the seats over time. These stains are difficult to prevent and cannot always be safely cleaned off.

 **CAUTION:** Do not use aftermarket, non-Tesla seat covers. Seat covers may cause staining or damage to the seats and may inhibit the sensitivity of a seat's occupancy sensors or restrict deployment of airbags.

Carpets

Avoid over-wetting carpets. For heavily soiled areas, use a diluted upholstery cleaner.

Seat Belts

Extend the belts to wipe. Do not use any type of detergent or chemical cleaning agent. Allow the belts to dry naturally while extended, preferably away from direct sunlight.

Door Seals

Wipe door seals with a damp cloth to remove any debris. Excessive debris on the door seals can cause damage when contacting surrounding surfaces. Avoid using alcohol wipes or any chemical products that can potentially deteriorate the coating on the door seals.





Touchscreen

Clean the touchscreen(s) using a soft lint-free cloth specifically designed to clean monitors and displays. Do not use cleaners (such as a glass cleaner) or alcohol-based gel products (such as hand sanitizer) and do not use a wet wipe or a dry statically-charged cloth (such as a recently washed microfiber). To wipe the front touchscreen without activating buttons and changing settings, you can enable Screen Clean Mode. Touch **Controls > Display > Screen Clean Mode**. The display darkens to make it easy to see dust and smudges. To exit Screen Clean Mode, press and hold **HOLD TO EXIT**.

Chrome and Metal Surfaces

Polish, abrasive cleaners, alcohol-based gel products (such as hand sanitizer), and hard cloths can damage the finish on chrome and metal surfaces.

Cautions for Interior Cleaning

-  **CAUTION:** Using solvents (including alcohol), alcohol-based gel products (such as hand sanitizer), bleach, citrus, naphtha, or silicone-based products or additives on interior components can cause damage.
-  **CAUTION:** Statically-charged materials can cause damage to the touchscreen.
-  **WARNING:** If you notice any damage on an airbag or seat belt, contact Tesla immediately.
-  **WARNING:** Do not allow any water, cleaners, or fabric to enter a seat belt mechanism.
-  **WARNING:** Exposure to chemical cleaners can be hazardous and can irritate eyes and skin. Read and observe the instructions provided by the manufacturer of the chemical cleaner.

Polishing, Touch Up, and Body Repair

To preserve the cosmetic appearance of the body, you can occasionally treat the paint surfaces with an approved polish containing:

- Very mild abrasive to remove surface contamination without removing or damaging the paint.
- Filling compounds that fill scratches and reduce their visibility.
- Wax to provide a protective coating between the paint and environmental elements.

Regularly inspect the exterior paint for damage. Treat minor chips and scratches using a paint touch-up pen (available for purchase from Tesla, depending on market region). Use the touch-up pen after washing but before polishing or waxing.

Repair rock chips, fractures or scratches. Refer to <https://www.tesla.com/support/body-shop-support> for more information on repair locations and available services.

⚠ CAUTION: Do not use cutting pastes, color restoration compounds, or polishes containing harsh abrasives. These can scour the surface and permanently damage the paint.

⚠ CAUTION: Do not use chrome polish or other abrasive cleaners.

Using a Car Cover

To preserve the cosmetic appearance of the body when Model Y is not being used, use a genuine Tesla car cover. Car covers can be purchased online from the Tesla Shop.

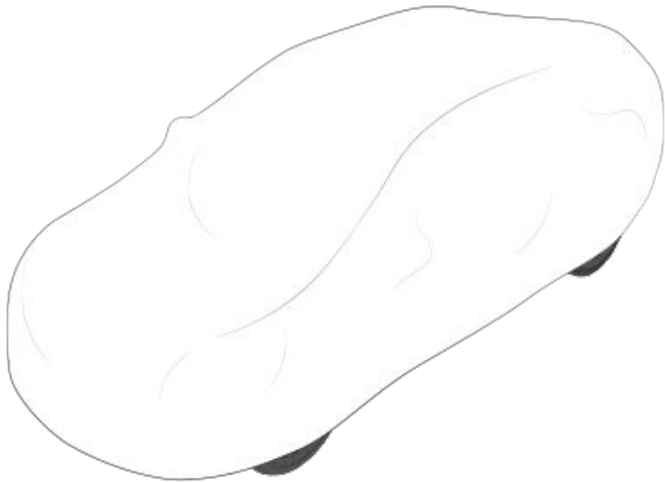

⚠ CAUTION: Use only a Tesla-approved car cover when Model Y is plugged in. Using a non-Tesla car cover can prevent the Battery from being adequately cooled during charging.

Floor Mats

To extend the life of your carpet and make them easier to clean, use genuine Tesla floor mats available online at <http://www.tesla.com>. Maintain floor mats by regularly cleaning them and checking that they are properly attached. Replace floor mats if they become excessively worn.

⚠ WARNING: To avoid potential interference with a foot pedal, ensure that the driver's floor mat is securely fastened, and never place an additional floor mat on top of it. Floor mats should always rest on top of the vehicle carpeting surface and not on another floor mat or other covering.



Windshield Wiper Blades, Jets and Fluid

Topping Up Windshield Washer Fluid

The only reservoir into which you can add fluid is the windshield washer fluid reservoir, which is located behind the front trunk. When the level is low, a message displays on the touchscreen.

To top up the washer fluid:

1. Open the hood.
2. Clean around the filler cap before opening it to prevent dirt from entering the reservoir.
3. Open the filler cap.
4. While avoiding spilling, fill the reservoir until the fluid level is visible just below the filler neck. The reservoir has a capacity of 4.5 liters.

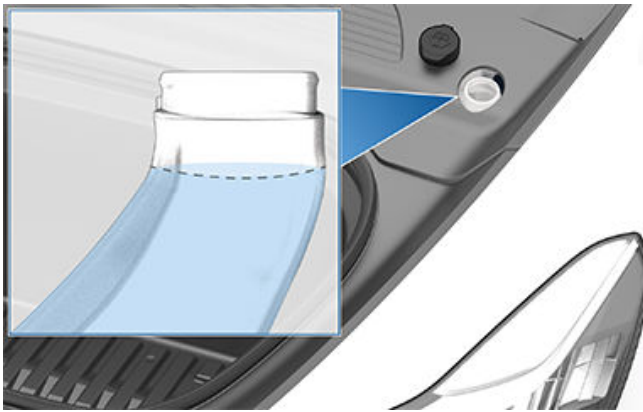

5. Wipe up any spills immediately and wash the affected area with water.
6. Reinstall the filler cap.

NOTE: Some national or local regulations restrict the use of Volatile Organic Compounds (VOCs). VOCs are commonly used as antifreeze in washer fluid. Use a washer fluid with limited VOC content only if it provides adequate freeze resistance for all climates in which you drive Model Y.

CAUTION: Use only ethanol-based windshield washer fluid meant for automotive vehicles. Using other substances, such as untreated water, can result in bacterial growth within the climate control system resulting in odor or potential damage that is not covered by warranty.

CAUTION: Do not add formulated washer fluids that contain water repellent or bug wash. These fluids can cause streaking, smearing, and squeaking or other noises.

WARNING: In temperatures below 4° C, use a washer fluid with antifreeze. In cold weather, using a washer fluid without antifreeze can impair visibility through the windshield.

WARNING: Windshield washer fluid can irritate eyes and skin. Read and observe the instructions provided by the washer fluid manufacturer.

Checking and Cleaning Wiper Blades

Periodically clean the edge of the wiper blades and check the rubber for cracks, splits, and roughness. If damaged, replace the blade immediately to prevent damage to the glass and improve visibility.

Contaminants on the windshield, or on the wiper blades, can reduce the effectiveness of the wipers. Contaminants include ice, wax spray from car washes, washer fluid with bug and/or water repellent, bird droppings, tree sap, and other organic substances.

Follow these guidelines for cleaning:

- Clean the windshield and wiper blades using washer fluid, isopropyl (rubbing) alcohol, or non-abrasive glass cleaner approved for use on automotive glass and rubber. Inappropriate products can cause damage or smears, and create glare on the windshield.
- Lift the wiper arm a short distance away from the windshield, just far enough to access the wiper blade. Do not lift a wiper arm beyond its intended position.

If the wipers remain ineffective after cleaning, replace the wiper blades.

NOTE: Ineffective wipers can lead to reduced visibility for the front windshield cameras, which may lead to degraded performance or unavailability of Autopilot features. For more information, see [Cameras on page 16](#) and refer to [Autopilot Limitations and Warnings on page 129](#).

Replacing Wiper Blades

For optimum performance, replace the wiper blades at least once a year. Replacement blades must meet the following criteria:

- The blade on the driver's side must be 650 mm long and 500 mm long for the blade on the passenger's side.
- Ensure the connector on the replacement blade is the same as the original blade. Different connectors may prevent the replacement blade from connecting to the wiper arm on the vehicle.

You can purchase replacement wiper blades on the [Tesla Shop](#).

NOTE: Only install replacement blades that are identical to the original blades. Using inappropriate blades can damage the wiper system and windshield.

To replace the wiper blades:

1. Shift into Park and turn off the wipers.
2. Touch **Controls > Service > Wiper Service Mode** to move the wipers to the service position.
3. Lift the wiper arm a short distance away from the windshield, just far enough to access the wiper blade.



! **CAUTION:** Wiper blades do not lock into a lifted position. Do not lift a wiper arm beyond its intended position.

4. Place a towel between the wiper arm and windshield to avoid scratching or cracking the windshield.
5. Hold the wiper arm and press the locking tab while sliding the blade down the arm.

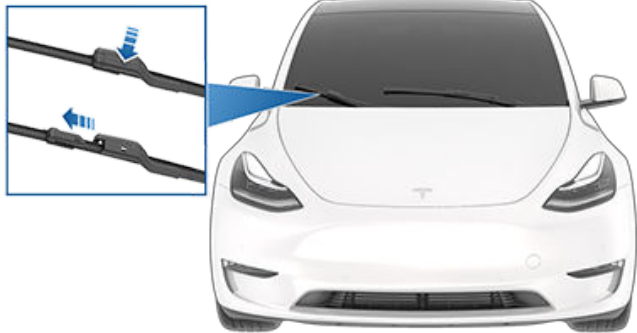

6. Align the new wiper blade on the wiper arm and slide it toward the end of the wiper arm until it locks into place.

! **CAUTION:** Ensure the new blade is locked in place and does not move. Perform a push-pull test to confirm. If not locked in place (you can hear and feel a "click"), the wiper blade may come off during use, resulting in serious damage.

7. Turn Wiper Service Mode off to return the wipers to their normal position.

Cleaning Washer Jets

If a windshield washer jet becomes blocked, use a thin strand of wire to clear any blockages from the nozzles.

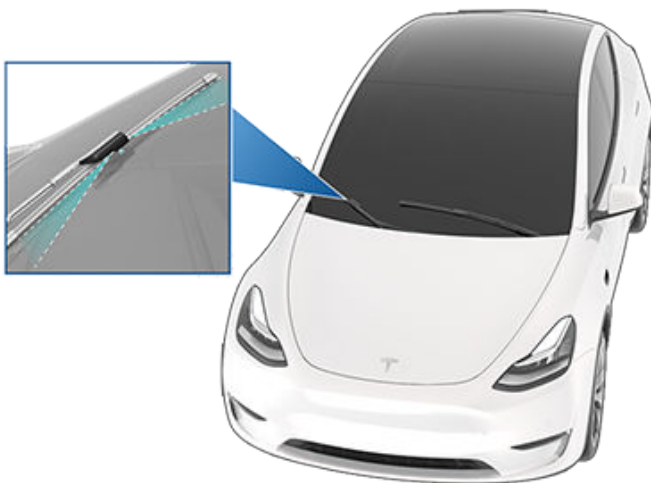

! **WARNING:** Do not operate the washers while cleaning Model Y. Windshield washer fluid can irritate eyes and skin. Read and observe the washer fluid manufacturer's instructions.



Jacking and Lifting

Follow the steps below to lift Model Y. Ensure that any non-Tesla repair facility is aware of these instructions, including lift points and warnings.

1. Position Model Y centrally between the lift posts.
2. Position the lift arm pads under the designated body lift points at the locations shown.

WARNING: DO NOT position the lift arm pads under the Battery or side rails.

NOTE: The following illustration is provided to improve conceptual understanding. The exact location of the lift points may differ slightly. Check the vehicle itself for exact location of lift points.

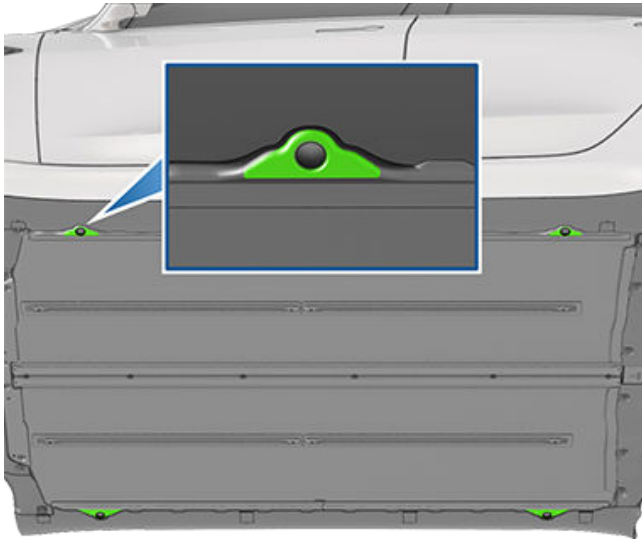

3. Adjust the height and position of the lift arm pads to ensure that they are correctly located.
4. With assistance, raise the lift to the desired height, ensuring the lift arm pads remain in their correct positions.
5. Engage any lift safety locks. Follow the lift manufacturer's instructions.

WARNING: Never raise Model Y when the charge cable is connected, even if charging is not in progress.

WARNING: Do not work on an incorrectly supported vehicle. Doing so can cause serious damage, bodily injury, or death.

CAUTION: It is your responsibility to be observant of the vehicle and its surroundings. Ensure the area is clear when lifting and lowering Model Y and that the doors, front trunk, and liftgate are closed as necessary to avoid damage.

CAUTION: DO NOT lift from under the Battery or side rails. Place the lift arm pads under the designated body lift points only. The locations shown are the only approved lifting points for Model Y. Lifting at any other points can cause damage. Damage caused by incorrectly lifting Model Y is not covered by the warranty.



Parts, Accessories, and Modifications

Use only genuine Tesla parts and accessories. Tesla performs rigorous testing on parts to ensure their suitability, safety, and reliability. Purchase these parts from Tesla, where they are professionally installed and where you can receive expert advice about modifications to Model Y. Accessories are available for purchase from Tesla stores or online at www.tesla.com.

NOTE: Adding accessories to your vehicle may impact expected range, vehicle dimensions, etc.

NOTE: Some accessories may not be available in your market region.

Tesla is unable to assess parts manufactured by other distributors and therefore accepts no responsibility if you use non-Tesla parts on Model Y.

WARNING: Installing non-approved parts and accessories, or performing non-approved modifications, can affect the performance of Model Y and the safety of its occupants. Any damage caused by using or installing non-approved parts, or by performing non-approved modifications, is not covered by the warranty.

WARNING: Tesla does not accept liability for death, personal injury or damage that occurs if you use or install non-approved accessories or make non-approved modifications.

Body Repairs

If your Model Y is in a collision, contact Tesla or a Tesla-approved Body Shop to ensure that it is repaired with genuine Tesla parts. Tesla has selected and approved body shops that meet strict requirements for training, equipment, quality, and customer satisfaction.

Some repair shops and insurance companies might suggest using non-original equipment or salvaged parts to save money. However, these parts do not meet Tesla's high standards for quality, fit and corrosion resistance. In addition, non-original equipment and salvaged parts (and any damage or failures they might cause) are not covered by the warranty.

Replacing Cabin Filters

Model Y has air filters that prevent pollen, industrial fallout, road dust, and other particles from entering the cabin through the vents. Tesla recommends replacing these filters every 2 years (every year in China). Cabin filters can be purchased at the [Tesla Shop](#).

To replace the cabin filters:

1. Turn off the climate control system.
2. Move the front right-hand side seat fully rearwards and remove the floor mat.

3. Use a clip pry tool to carefully release the push clips that secure the front right-hand side footwell cover to the instrument panel. Then, while supporting the footwell cover, disconnect the two electrical connectors and move the footwell cover aside.
 - For the light, carefully press down on the tab while releasing the connector.
 - For the speaker, carefully angle the vehicle-side connector so that the small tab releases from the hole in the footwell cover-side connector while releasing the connector.

CAUTION: To avoid damage, do not pull on the wires when disconnecting the connectors. When disconnecting the connectors, make sure to pull from the plastic on the connectors themselves.

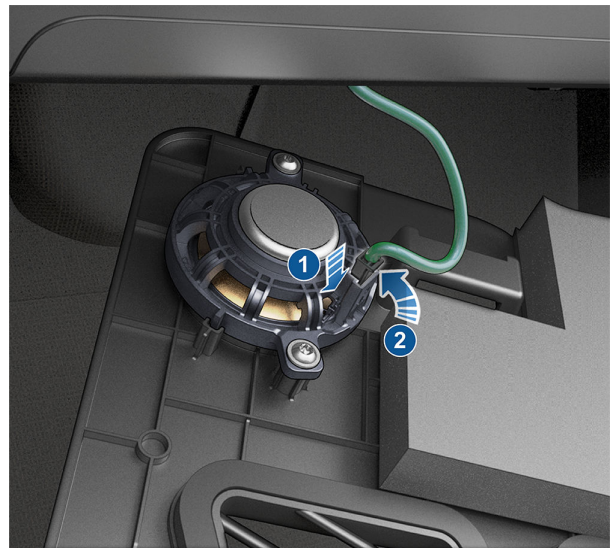

4. Working from top-to-bottom, use a trim tool to carefully release the right side panel from the center console.
5. Remove the 6 mm screw that secures the cabin filter cover to the heating, ventilation, and air conditioning (HVAC) module, then release the cabin filter cover and move it aside. On some vehicles, tabs replace the 6 mm screw: use your index finger and thumb to squeeze the two tabs at the bottom of the cabin filter cover. Tilt the cover outward to remove.



CAUTION: To avoid damage that is not covered by the warranty, replace your low voltage lead-acid battery with the same type of battery. The low voltage lead-acid battery for North American vehicles is **AtlasBX / Hankook 85B24LS 12V 45Ah**. You can purchase a new lead-acid low voltage battery that is compatible with your vehicle from your local service center.

You can purchase a new low voltage battery, or dispose of an old one, at a Tesla Service Center.

Perform the following procedure to replace the lead-acid low voltage battery. Wear appropriate personal protection equipment (such as safety glasses, leather gloves when handling the lead-acid battery, etc.).

Removal:

1. Prepare the vehicle to remove the low voltage lead-acid battery:
 - a. Ensure the vehicle is in Park.
 - b. Lower all windows.
 - c. Open the front trunk.
 - d. Leave a door propped open so you can get back into the vehicle if needed.
 - e. Disconnect the charge cable from the charge port.
2. In the front trunk, remove the vehicle's underhood apron by inserting a small, non-marring flat tool or your fingers underneath the panel. Pull up to loosen the clips and set the underhood apron aside.



6. Fold the upper cabin filter's pull tabs outward.
7. Holding the tabs on the upper cabin filter, pull the upper filter out from the HVAC module.
8. Holding the upper tab on the lower cabin filter, pull the lower filter upwards and then out from the HVAC module.
9. Ensuring that the arrows on both new filters face towards the **rear** of the vehicle, insert the lower cabin filter into the HVAC module and lower it into place. Then, insert the upper cabin filter above it.
10. Fold the tabs inward so that the cabin filter cover can be installed.
11. Install the cabin filter cover by engaging the lower cover tab then securing the 6 mm screw. Tighten the screw to 1.2 Nm/0.89 ft-lbs. On vehicles with tabs instead of a 6 mm screw: maneuver the top notch of the cabin filter cover into place, then secure the tabs at the bottom of the HVAC module.
12. Reconnect the two electrical connectors to the components in the front right-hand side footwell cover, then resecure the cover with the push clips.
13. Align the right side panel with the front and rear locator slots on the center console, then apply pressure until all of the clips are fully secure.
14. Reinstall the front right-hand side floor mat then move the front right-hand side seat back into place.

Replacing the Low Voltage Lead-Acid Battery



CAUTION: It is your responsibility to monitor the low voltage battery health. Damage to the low voltage battery due to running out of range is not covered by the warranty.

3. If equipped, remove the HEPA filter:
 - a. Using a 10mm socket, remove the bolt that attaches the washer fluid reservoir neck to the underhood storage unit.

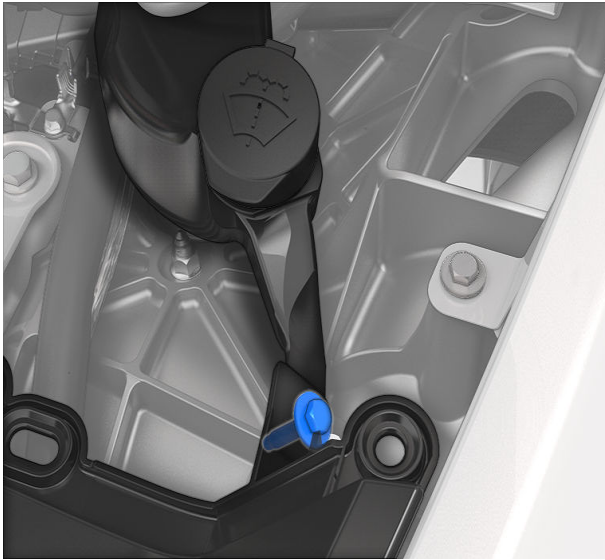

- b. Remove the washer tank neck from the vehicle. If the windshield washer reservoir is full, some washer fluid may leak out.

NOTE: You do not need to remove the hose from the neck.

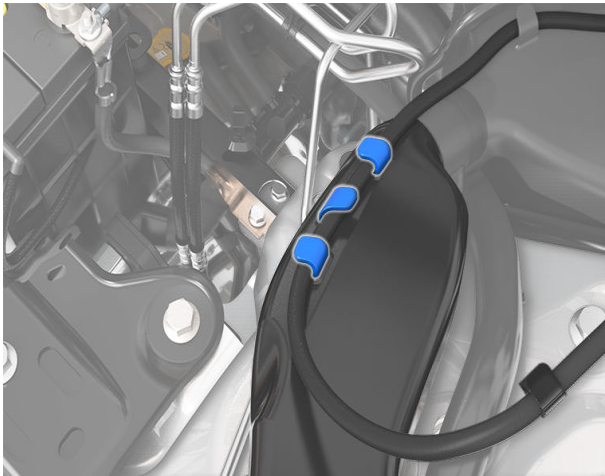

- c. With a 10mm socket, remove the bolts (x2) that attach the HEPA filter assembly to the vehicle.

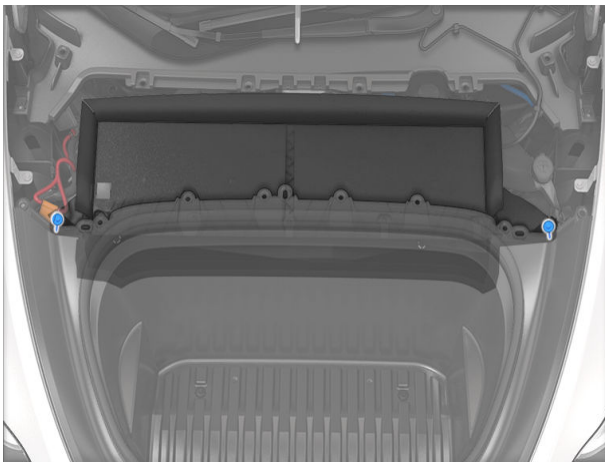

- d. Remove the HEPA filter assembly from the vehicle by tilting the rear edge of the filter assembly up past the brake fluid reservoir. Lift the filter assembly out of the vehicle, taking care not to bump into or damage other components.

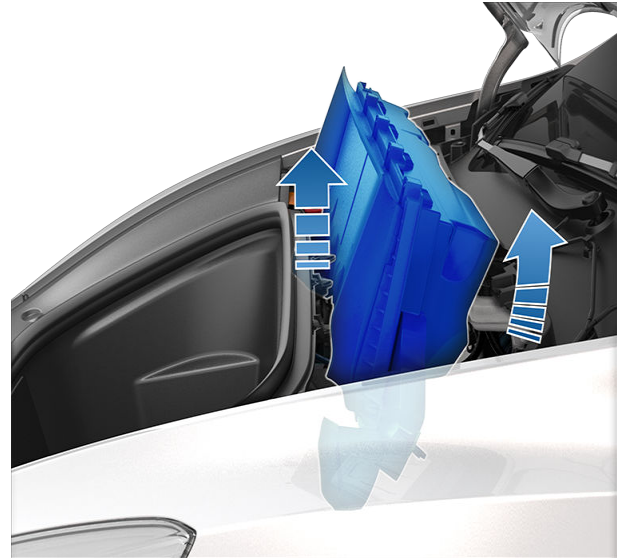

4. Power off the vehicle by navigating to **Controls > Safety > Power Off** on the touchscreen.
5. With a 10mm socket, loosen the nut that secures the negative (-) terminal clamp to the negative (-) post on the lead-acid battery. Release the terminal clamp from the negative (-) post.

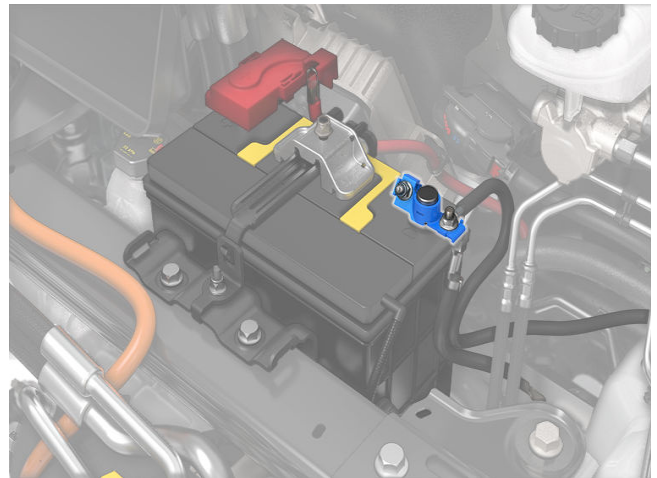

6. Disconnect the first responder loop by sliding the red locking tab toward you and pressing the black tab.

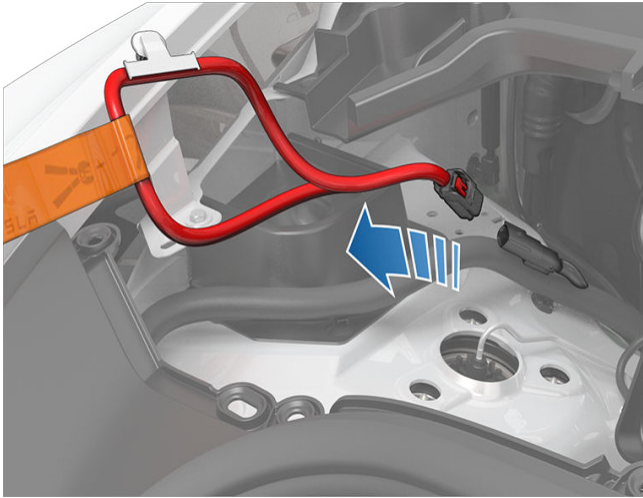

7. With a 10mm socket, release the terminal cover and loosen the nut that secures the positive (+) terminal clamp to the positive (+) post on the lead-acid battery. Release the terminal clamp from the positive (+) post and cover the terminal clamp with a dry rag.



CAUTION: Do not allow the positive (+) terminal clamp to contact nearby components like the lead-acid battery hold down bracket or A/C cooling lines.

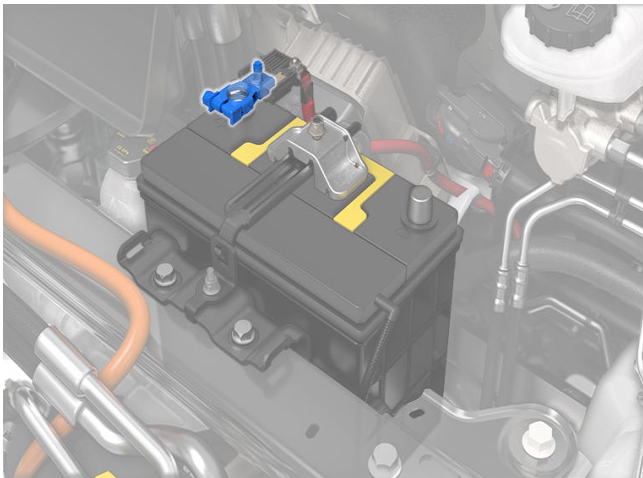

8. Unplug the vent tube hose from the negative (-) terminal side of the lead-acid battery.

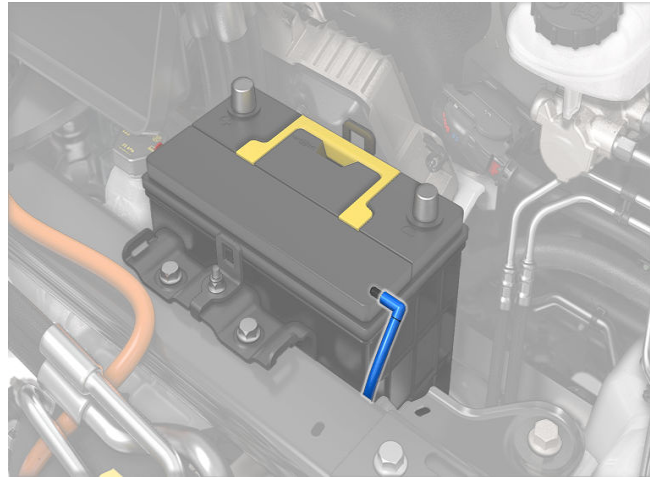

9. Loosen the nut on the battery hold down on the top of the lead-acid battery with a 10mm socket. To release the battery hold down, unhook and slide the strap back. If needed, tilt the battery hold down backward so it does not slip into the vehicle.

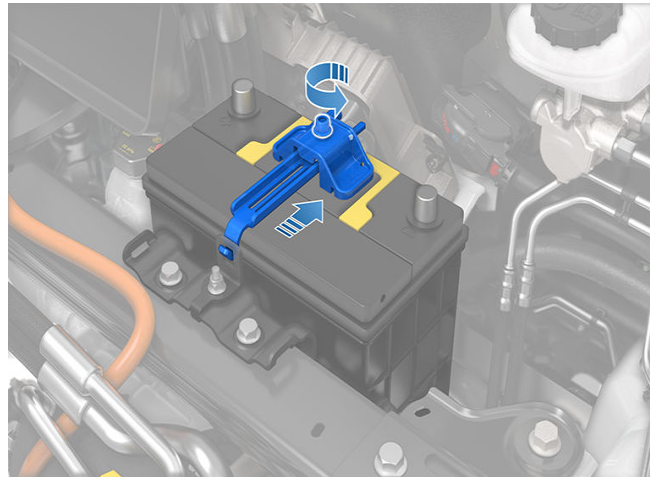

10. Using the battery handle, carefully remove the lead-acid battery, taking care not to touch or damage the surrounding components.



WARNING: When lifting out the lead-acid battery, stand in front of the vehicle and use proper lifting technique. The lead-acid battery weighs approximately 25 lb (12 kg). Failure to do so may cause serious injury.



11. Inspect the new lead-acid battery to ensure it has a red plug in the casing on the positive (+) terminal side. If the new lead-acid battery does not have a red plug, use a small trim tool to transfer the red plug from the old battery to the new one.

⚠ CAUTION: Dispose of the old low voltage lead-acid battery at a Tesla Service Center, or according to local laws (such as dropping it off at a battery recycling facility). Keep the low voltage battery upright and place it on a towel or piece of cardboard when transporting.



Installation:

1. Carefully maneuver the new lead-acid battery into place, taking care not to touch or damage nearby components.
2. Install the lead-acid battery hold down and use a 10mm socket to tighten the nut that secures it to the 12V battery. Torque the nut to 6 Nm (4.4 ft-lb).

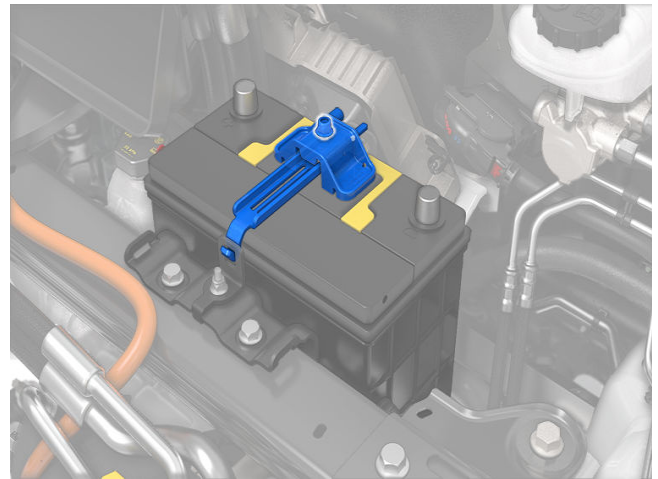

3. Reconnect the first responder loop.

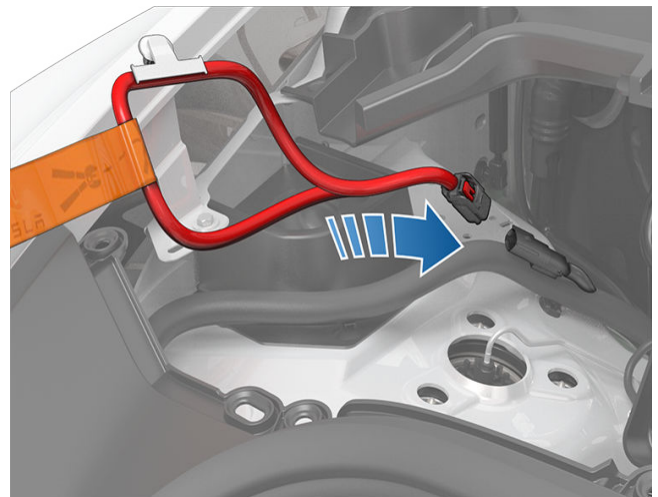

4. Remove the protective caps from the positive (+) and negative (-) posts on the new low voltage lead-acid battery.
5. Connect the positive (+) terminal by positioning the clamp over the positive (+) post. Using a 10mm socket, torque the nut to 6 Nm (4.4 ft-lb).

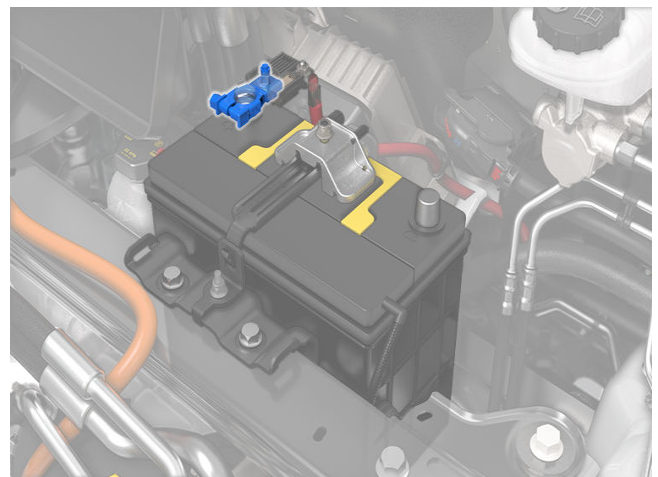

6. Install the positive (+) terminal cover.



Parts and Accessories

7. Connect the negative (-) terminal by positioning the clamp over the negative (-) post. Using a 10mm socket, torque the nut to 6 Nm (4.4 ft-lb).

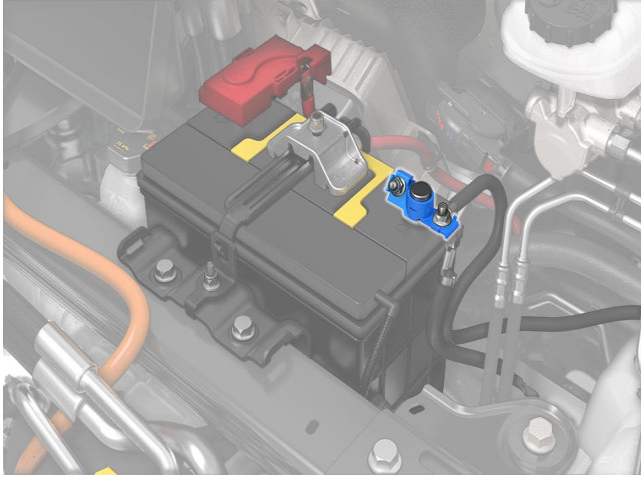

8. Connect the vent tube hose into the negative (-) terminal side of the lead-acid battery.

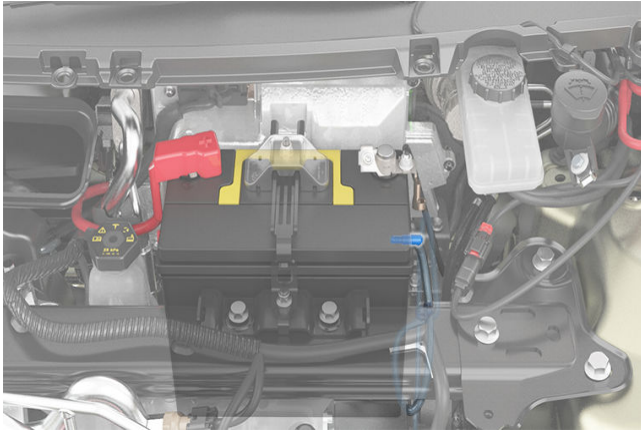

9. Open one of the vehicle's doors to ensure power has been correctly restored and the touchscreen turns on (this may take several minutes).

10. If equipped, install the HEPA filter:

- a. Carefully maneuver the HEPA filter assembly into place, taking care not to touch or damage other components.

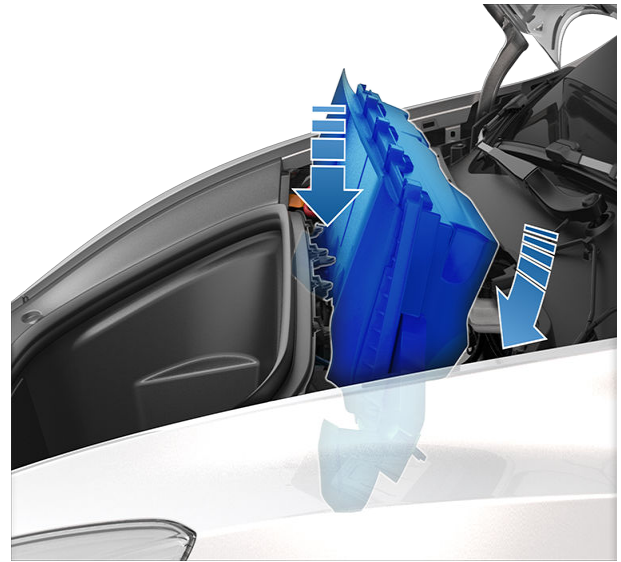

- b. With a 10mm socket, tighten the bolts (x2) and torque them to 5 Nm (3.7 ft-lb).

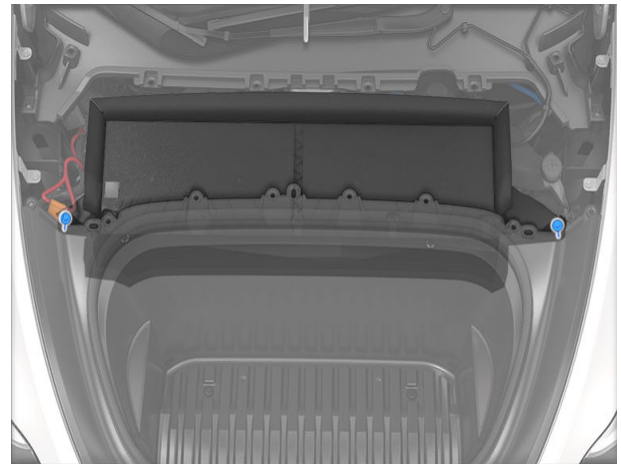

- c. Ensure the O-ring on the washer tank neck is fully seated, then install the washer tank neck by inserting it into the washer tank.

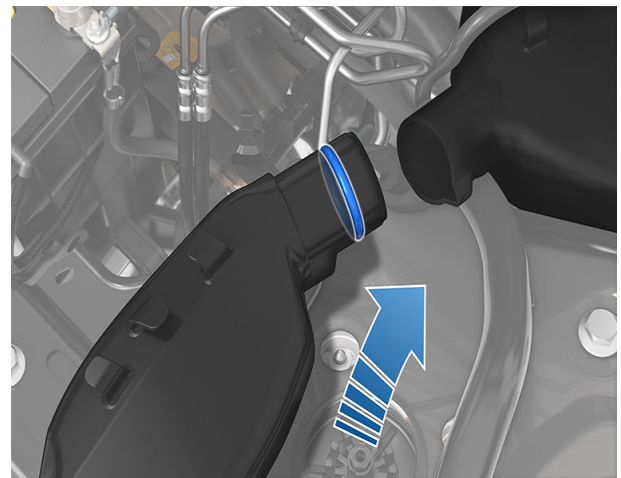

- d. Route the hose so that it is secured by the tab.

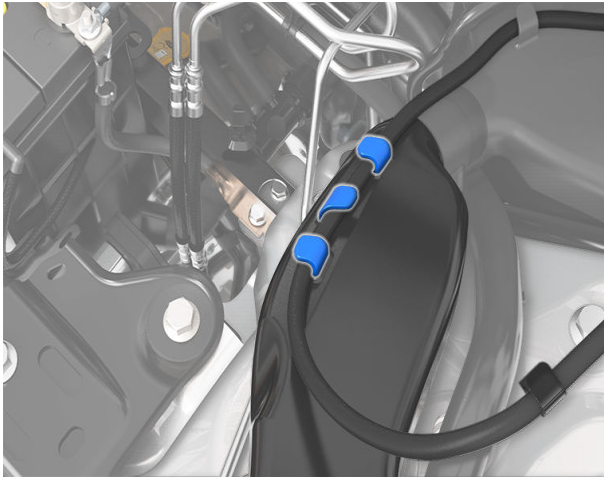

- e. Use a 10mm socket to install the bolt that attaches the washer fluid reservoir neck to the underhood storage unit. Torque the bolt to 5 Nm (3.7 ft-lb).

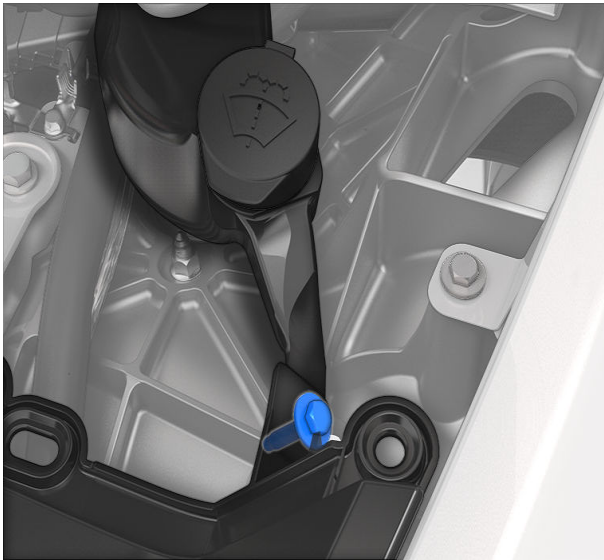

11. Replace the underhood apron by aligning the clips into their openings in the front trunk. Press down to lock them in place. The clips make an audible clicking sound when secured.



12. Close the front trunk. If an alert to replace the low-voltage battery was previously shown on the touchscreen, ensure the alert no longer appears.

Using RFID Transponders

When attaching an RFID transponder (used by many automated toll systems) inside Model Y, place the transponder next to the rear view mirror. This ensures best results and minimizes any obstruction to your driving view. Refer to the RFID manufacturer's instructions for specific placement.

NOTE: You can also attach a weather-proof transponder to the front license plate.



Do It Yourself Maintenance

Learn how to perform simple Do It Yourself procedures, such as replacing wiper blades and cabin filters, or installing the paint protection film kit. Go to <https://www.tesla.com/support/do-it-yourself-guides> for instructions, animations, and videos of these procedures.

NOTE: Due to market region or vehicle configuration specifics, some parts and procedures may not be available for your vehicle. When navigating to <https://www.tesla.com/support/do-it-yourself-guides>, select your vehicle, region, and/or language to see an updated list of parts and accessories available for your region.

 **CAUTION:** Perform each procedure in a dry and well-lit area. For your safety, only perform a procedure if you feel comfortable doing so, and always follow provided instructions.



Vehicle Identification Number

You can find the VIN at the following locations:

- Touch **Controls** > **Software** on the touchscreen.
- Stamped on a plate located at the top of the dashboard. Can be seen by looking through the windshield.



- Printed on the Statutory Plate, located on the door pillar. Can be seen when the front door is open.



- Cars manufactured in the Fremont Factory : The VIN is stamped into the right side upper door pillar and can be seen when the interior trim is removed.



- Cars manufactured in Gigafactory Berlin: The VIN is located on a label stamped onto the rear right door sill that can be seen when the interior trim is removed.

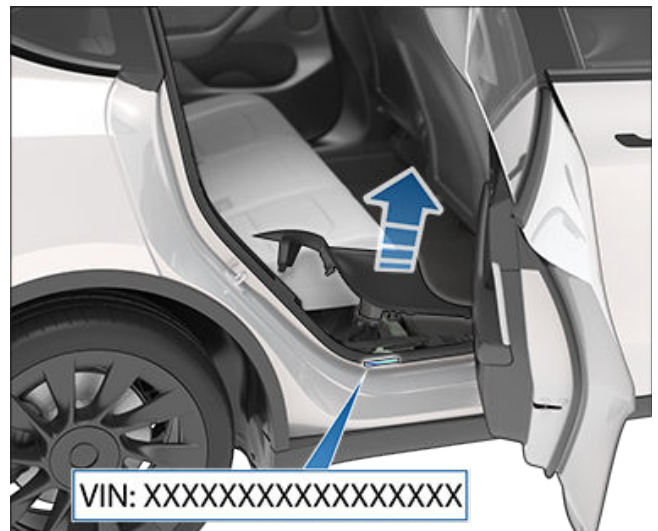

- Cars manufactured in Gigafactory Shanghai: The VIN is stamped onto the floor and can be seen by moving the front right seat rearward and lifting the carpet.



Identification Labels



Vehicle Labeling

It is important to understand your vehicle's original tire sizes and pressures, and the TPMLM (Technically Permissible Maximum Label Mass) and TPMAM (Technically Permissible Maximum Mass on Axle). This information can be found on two labels attached to Model Y.

Both labels are visible on the door pillar when the front door is open.

NOTE: If your Model Y is fitted with Tesla accessory wheels or tires, your Model Y may include an additional label indicating that values may differ from what is stated on the label.

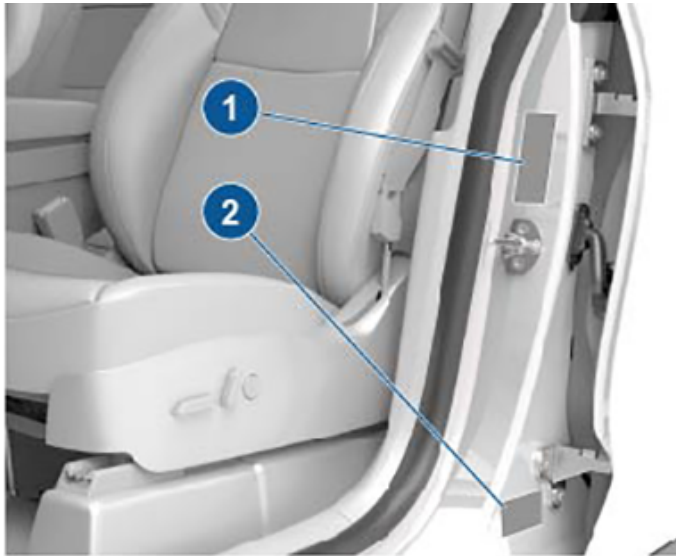

1. Tire Information Label
2. Statutory Plate

 **WARNING:** Overloading Model Y has an adverse effect on braking and handling, which can compromise your safety or cause damage.

 **CAUTION:** Never store large amounts of liquid in Model Y. A significant spill can cause electrical components to malfunction.

Tire Information Label

The Tire Information label provides:

- The maximum number of occupant seating positions.
- The size of the original tires.
- The cold inflation pressures for the original front and rear tires. These pressures are recommended to optimize ride and handling characteristics.

Label Format:

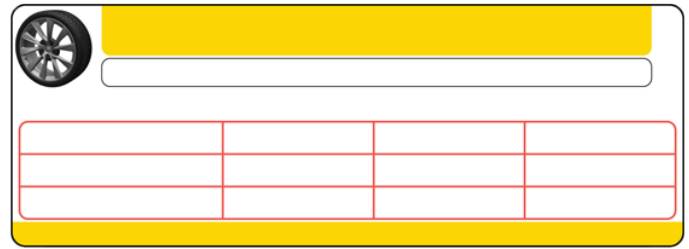

Never change this label, even if you use different tires in the future.

NOTE: If Model Y is loaded to its full capacity, double check all tires to ensure they are inflated to their recommended pressure levels.

Statutory Plate

In addition to the VIN, the Statutory Plate provides:

- TPMLM - Technically Permissible Maximum Laden Mass. The maximum allowable total mass of Model Y. This is calculated as the weight of Model Y, all passengers, fluids, and cargo.
- TPMAM - Technically Permissible Maximum Mass on Axle, for the front and rear axles. The TPMAM is the maximum distributed weight that each axle can support.

 **CAUTION:** To prevent damage, never load Model Y so that it is heavier than TPMLM or exceeds the individual TPMAM weights.

Roof Racks

Model Y supports the use of Tesla-approved roof racks using a Tesla mounting accessory. To install roof racks, you must use this accessory and you must use only roof rack systems that have been approved by Tesla (see [Parts and Accessories on page 199](#)). Failure to do so can cause significant damage.



Dimensions

Exterior Dimensions

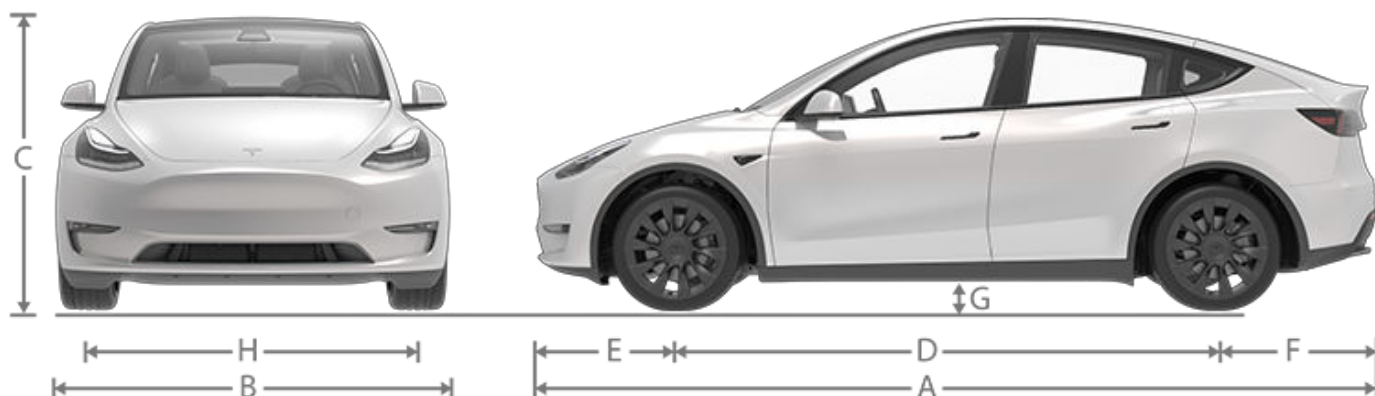

A	Overall Length	187 in	4751 mm
B	Overall Width (including mirrors) Overall Width (including folded mirrors) Overall Width (excluding mirrors)	83.8 in 77.9 in 75.6 in	2129 mm 1978 mm 1921 mm
C	Overall Height	64 in	1624 mm
D	Wheel Base	113.8 in	2890 mm
E	Overhang - Front	34.4 in	875 mm
F	Overhang - Rear	38.8 in	986 mm
G	Ground Clearance (with 2 passengers)	Performance 6.2 in Non-Performance 6.8 in	Performance 157 mm Non-Performance 172 mm
H	Track, non 21" wheels - Front Track, non 21" wheels - Rear Track, 21" wheels - Front Track, 21" wheels - Rear	64.4 in 64.4 in 64.8 in 64.2 in	1636 mm 1636 mm 1646 mm 1630 mm

*Values are approximate. Dimensions can vary depending on a vehicle's options and various other factors.

**The track of the vehicle is based on measurements at the wheel center.

CAUTION: Depending on configuration (such as wheel selection), your vehicle's liftgate can open up to approximately 2.3 meters high. See [Adjusting Liftgate Opening Height on page 25](#) to adjust the liftgate height and prevent it from coming into contact with low ceilings or other objects.



Interior Dimensions

Head Room	Front Rear	41.0 in 39.4 in	1041 mm 1001 mm
Leg Room	Front Rear	41.8 in 40.5 in	1063 mm 1029 mm
Shoulder Room	Front Rear	56.4 in 54 in	1432 mm 1373 mm
Hip Room	Front Rear	53.8 in 50.6 in	1367 mm 1286 mm

Cargo Volume

Model Y with 5 Seats:

Front trunk	4.1 cu ft (117 L)
Behind first row, second row seats folded	72.1 cu ft (2041 L)
Behind second row, seats not folded	30.2 cu ft (854 L)
Maximum total cargo volume with driver and front passenger	76.2 cu ft (2158 L)
Maximum total cargo volume with 5 passengers	34.3 cu ft (971 L)



Motor Type(s)

Rear motor: AC permanent magnet synchronous motor, liquid-cooled, with variable frequency drive.

Front motor (AWD vehicles): AC induction motor, liquid-cooled, with variable frequency drive.

Transmission

Transmission	Specifications
Type	Single speed fixed gear
Gearbox Ratio	9:1

Steering

Steering	Specifications
Type	Rack and pinion with electronic power steering, speed sensitive
Number of turns lock to lock	2.00
Turning Circle (curb to curb)	12.13 meters

Brakes

Brakes	Specifications
Type	4-wheel anti-lock braking system (ABS) with Electronic Brake Force Distribution, Integrated Advanced Stability Control and Electronic Accelerator pedal actuated regenerative braking system
Rotor Diameter (ventilated)	Front (non-Performance): 14.0"/355 mm Front (Performance): 14.0"/355 mm Rear (non-Performance): 13.2"/335 mm Rear (Performance): 13.2"/335 mm
Front Rotor thickness	New (non-performance): 0.98"/25 mm New (performance): 0.98"/25 mm Service limit (non-performance): 0.91"/23 mm Service limit (performance): 0.91"/23 mm
Rear Rotor thickness	New (non-performance): 0.79"/20 mm New (performance - Mando calipers): 0.79"/20 mm New (performance - Brembo calipers): 0.87"/22 mm Service limit (non-performance): 0.71"/18 mm Service limit (performance - Mando calipers): 0.71"/18 mm Service limit (performance - Brembo calipers): 0.79"/20 mm
Lateral runout	0.050 mm

Brakes	Specifications
Chordal runout	0.040 mm
Disk thickness variation (DTV)	0.010 mm
Front Brake Pad Thickness (excluding back plate)	New: 0.393"/10 mm Service limit: 0.085"/2.15 mm
Rear Brake Pad Thickness (excluding back plate)	New: 0.354"/9 mm Service limit: 0.078"/2 mm
Performance Front Brake Pad Thickness (excluding back plate)	New: 0.393"/10 mm Service limit: 0.085"/2.15 mm
Performance Rear Brake Pad Thickness (excluding back plate)	New: 0.354"/ 9 mm Service limit: 0.071"/1.8 mm
Parking brake	Electrically actuated parking brake integrated into rear caliper

Suspension

Suspension	Specifications
Front	Independent, double wishbone, coil spring/telescopic damper, stabilizer bar
Rear	Independent, multi-link, coil spring/telescopic damper

Battery - Low Voltage

Lead Acid Battery - Low Voltage	Specifications
Rating	45 amp hour
Voltage and Polarity	12V
Lithium Ion Battery - Low Voltage	Specifications
Rating	6.9 amp hour
Voltage	15.5V

Battery - High Voltage

Battery - High Voltage	Specifications
Type	Liquid-cooled lithium ion (Li-ion)
Nominal Voltage	345 V DC
Temperature Range	Do not expose Model Y to ambient temperatures above 60° C or below -30° C for more than 24 hours at a time.



Wheel Specifications (Factory)

Wheel Type	Location	Size	Offset (mm)
19"	Front/Rear	19 x 9.5J	45
20"	Front/Rear	20 x 9.5J	45
21"	Front	21 x 9.5J	40
21"	Rear	21 x 10.5J	48

Lug Nut Torque	129 lb. ft (175 Nm)
Lug Nut Socket Size	21 mm

NOTE: For instructions on how to jack/lift Model Y, see [Jacking and Lifting on page 198](#).

Tire Specifications (Factory)

Tire Size	Location	Size
19"	Front/Rear	255/45R19 XL
20"	Front/Rear	255/40R20 XL
21"	Front	255/35R21 XL
21"	Rear	275/35R21 XL

Tire pressures vary depending on the type of tires fitted. Refer to the tire pressures printed on the Tire Information label. This label is located on the center door pillar and is visible when the driver's door is open (see [Maintaining Tire Pressures on page 185](#)).

Winter tires can be purchased from a Tesla service center or may be available for purchase on the Tesla web site.



Understanding Tire Markings

Laws require tire manufacturers to place standardized information on the sidewall of all tires. This information identifies and describes the fundamental characteristics of the tire.



1. **Tire category:** P indicates that the tire is for passenger vehicles.
2. **Tire width:** This 3-digit number is the width (in millimeters) of the tire from sidewall edge to sidewall edge.
3. **Aspect ratio:** This 2-digit number is the sidewall height as a percentage of the tread width. So, if the tread width is 205 mm, and the aspect ratio is 50, the sidewall height is 102 mm.
4. **Tire construction:** R indicates that the tire is of Radial ply construction.
5. **Wheel diameter:** This 2-digit number is the diameter of the wheel rim in inches.
6. **Load index:** This 2 or 3-digit number is the weight each tire can support. This number is not always shown.
7. **Speed rating:** When stated, indicates the maximum speed (in mph) at which the tire can be used for extended periods. Q=99 mph (160 km/h), R=106 mph (170 km/h), S=112 mph (180 km/h), T=118 mph (190 km/h), U=124 mph (200 km/h), H=130 mph (210 km/h), V=149 mph (240 km/h), W=168 mph (270 km/h), Y=186 mph (300 km/h), (Y)=vehicle's top speed (exceeds the "Y" rating).
8. **Load range:** Shown as Standard Load (SL) or Extra Load (XL), the load range determines how much weight your tires can support at a specified tire pressure. When replacing tires, only use tires of the same load range. If towing with snow tires, ensure they are the same load range of the tires your vehicle came equipped with.



Wheels and Tires

9. **Tire composition and materials:** The number of plies in both the tread area and the sidewall area indicates how many layers of rubber coated material make up the structure of the tire. Information is also provided on the type of materials used.
10. **Maximum tire load:** The maximum load which can be carried by the tire.
11. **Maximum permissible inflation pressure:** This pressure should not be used for normal driving.
12. **U.S. DOT Tire Identification Number (TIN):** Begins with the letters DOT and indicates that the tire meets all federal standards. The next 2 digits/letters represent the plant code where it was manufactured, and the last 4 digits represent the week and year of manufacture. For example, the number 1712 is used to represent the 17th week of 2012. The other numbers are marketing codes used at the manufacturer's discretion. This information can be used to contact consumers if a tire defect requires a recall.
13. **Treadwear grade:** This number indicates the tire's wear rate. The higher the treadwear number is, the longer it should take for the tread to wear down. A tire rated at 400, for example, lasts twice as long as a tire rated at 200.
14. **Traction grade:** Indicates a tire's ability to stop on wet roads. A higher graded tire should allow you to stop your vehicle in a shorter distance than a tire with a lower grade. Traction is graded from highest to lowest as AA, A, B, and C.
15. **Temperature grade:** The tire's resistance to heat is grade A, B, or C, with A indicating the greatest resistance. This grading is provided for a correctly inflated tire, which is being used within its speed and loading limits.



DO NOT TRANSPORT WITH WHEELS ON THE GROUND

The motors in Model Y generate power when the wheels spin. Always transport Model Y with all four tires off the ground. Ensure that the tires are unable to spin at any time during transport.

⚠ WARNING: NEVER TRANSPORT YOUR VEHICLE WITH THE TIRES IN A POSITION WHERE THEY CAN SPIN. DOING SO CAN LEAD TO SIGNIFICANT DAMAGE AND OVERHEATING. IN RARE CASES EXTREME OVERHEATING MAY CAUSE THE SURROUNDING COMPONENTS TO IGNITE.



Do not transport Model Y using any method that is not specified by Tesla. Adhere to the instructions provided in the following sections and observe all warnings and cautions provided. Damage caused by improper transporting of your vehicle is not covered by the warranty.

NOTE: Tesla is not liable or responsible for reimbursing services not dispatched through Tesla Roadside Assistance.

Approved Methods for Transporting

A flatbed truck or comparable transport vehicle is the recommended method of transporting Model Y. The vehicle can face either direction when using a flatbed.



If Model Y must be transported without a flatbed truck, then wheel lifts and dollies must be used to ensure that all four wheels are off of the ground. This method may only be used for a maximum of 55 km, and must not exceed the manufacturer speed rating of the dollies. With this method, Tesla recommends the vehicle facing forward so that the front wheels are lifted and the rear wheels are on dollies.



⚠ CAUTION: Enable Transport Mode (see [Activate Transport Mode on page 217](#)) before winching Model Y onto a flatbed truck (see [Pull Onto Flatbed Truck From Front on page 218](#) and [Pull Onto Flatbed Truck From Rear on page 218](#)). If Transport Mode is not available or the touchscreen is not accessible, self-loading dollies or tire skates must be used to load the vehicle into the approved transportation position. Tesla is not responsible for any damage caused by or during the transport of Model Y, including personal property damage or damage caused by using self-loading dollies or tire skates.

NOTE: Transport Mode is only intended to allow for winching Model Y onto a flatbed truck or repositioning the vehicle out of a parking space. While in Transport Mode, the tires are allowed to rotate slowly (under 5 km/h) and for a very short distance (less than 10 meters). See [Activate Transport Mode on page 217](#). Exceeding these boundaries can lead to significant damage and overheating that is not covered by the warranty.

⚠ WARNING: Model Y is equipped with high voltage components that may be compromised as a result of a collision (see [High Voltage Components on page 170](#)). Before transporting Model Y, it is important to assume these components are energized. Always follow high voltage safety precautions (wearing personal protection equipment, etc.) until emergency response professionals have evaluated the vehicle and can accurately confirm that all high voltage systems are no longer energized. Failure to do so may result in serious injury.

Activate Transport Mode

Transport Mode keeps the parking brake disengaged while winching Model Y onto a flatbed truck. When active, Transport Mode displays a message indicating that the vehicle will remain free-rolling. To enable Transport Mode:

- Low voltage power is required. You will be unable to use the touchscreen to activate Transport Mode if Model Y has no power.
- Model Y must detect a key. Transport Mode is available only when a key is detected.
- Ensure the vehicle is not connected to a charger. Transport Mode is not available if Model Y is still plugged in.

To activate Transport Mode:

1. Ensure Model Y is in Park.
2. Chock the tires or make sure Model Y is secure.



Instructions for Transporters

3. Press and hold the brake pedal, then on the touchscreen, touch **Controls** > **Service** > **Towing**. The touchscreen displays a message reminding you how to properly transport Model Y.
4. Touch **Enter Transport Mode**. The button turns blue to show that Model Y is now in Transport Mode. Model Y is now free-rolling and can be rolled slowly (no faster than walking speed) for short distances or winched (for example, onto a flatbed truck).

To cancel Transport Mode, touch **Exit Transport Mode** or shift Model Y into Park. If your phone key is not detected, canceling Transport Mode powers off Model Y. You may need your key card to restart the vehicle.

NOTE: If your vehicle is equipped with a lead-acid low voltage battery (see [Jump Starting on page 223](#)): Transport Mode may cancel if Model Y loses low voltage power after Transport Mode is enabled.

CAUTION: If the electrical system is not working, and you therefore cannot use the touchscreen to activate Transport Mode, use self-loading dollies or tire skates. Before doing so, always check the manufacturer's specifications and recommended loading capacity.

Pull Onto Flatbed Truck From Front

NOTE: If Model Y has no low voltage power, you need an external low voltage power supply to open the hood or use the touchscreen.

CAUTION: To avoid damage, only pull the vehicle onto a flatbed truck using a properly-installed tow eye. Using the chassis, frame, or suspension components to pull the vehicle can result in damage.

1. Locate the tow eye. The tow eye is located in the front trunk.



2. Release the front tow eye cover by pressing firmly on its top right perimeter until it pivots inward, then gently pulling the raised section toward you.

NOTE: The front tow eye cover is connected to the vehicle's black negative (-) terminal.

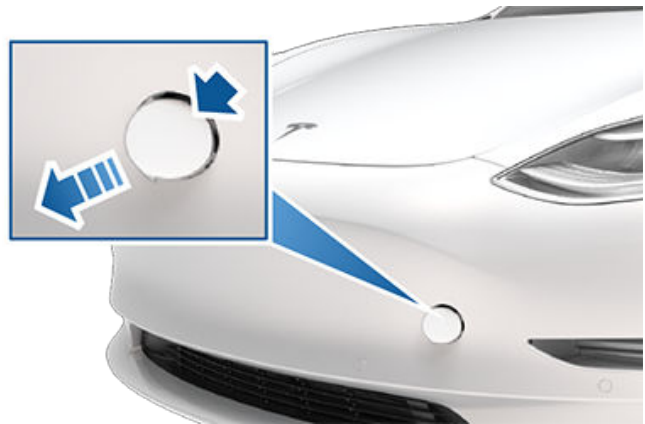

3. Fully insert the tow eye into the opening, then turn it **counter-clockwise** until securely fastened.

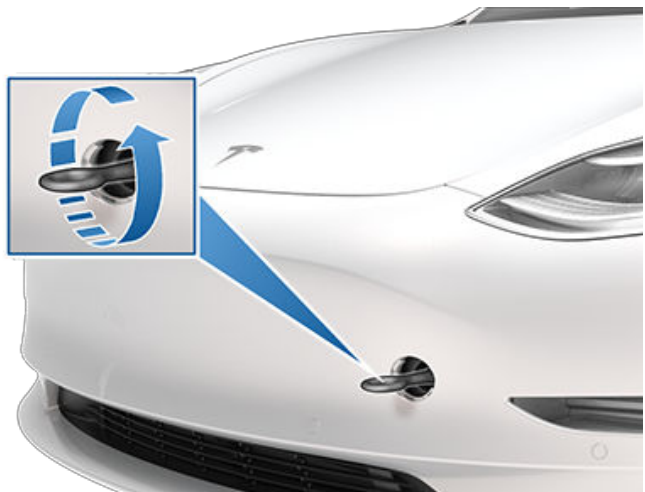

4. Attach the winch cable to the tow eye.

CAUTION: Before pulling, make sure the tow eye is securely tightened.

5. Activate Transport Mode.
6. Pull Model Y slowly onto the flatbed truck.

Pull Onto Flatbed Truck From Rear

NOTE: If Model Y has no low voltage power, you need an external low voltage power supply to open the hood or use the touchscreen.

CAUTION: To avoid damage, only pull the vehicle onto a flatbed truck using a properly-installed tow eye. Using the chassis, frame, or suspension components to pull the vehicle can result in damage.

1. Locate the tow eye. The tow eye is located in the front trunk.



2. Release the rear tow eye cover by pressing firmly on its top right perimeter until it pivots inward, then gently pulling the raised section toward you.

NOTE: Vehicles equipped with a hitch receiver cannot be pulled from the rear tow eye. Use the tow bar or hitch receiver only to pull the vehicle to a safe location, such as onto a flatbed truck. Do not transport the vehicle with wheels on the ground.

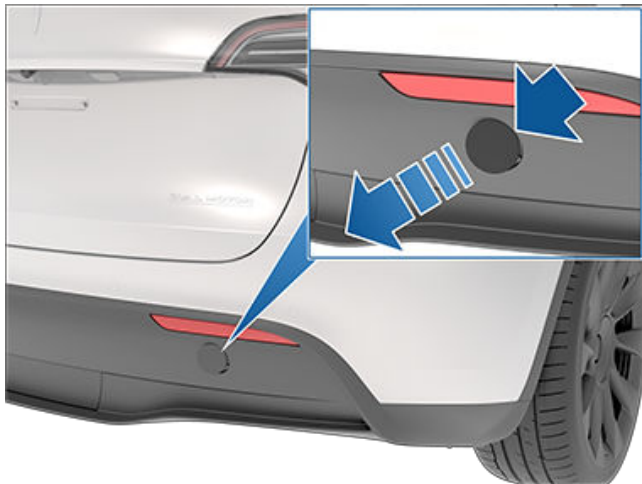

3. Fully insert the tow eye into the opening, then turn it **counter-clockwise** until securely fastened.

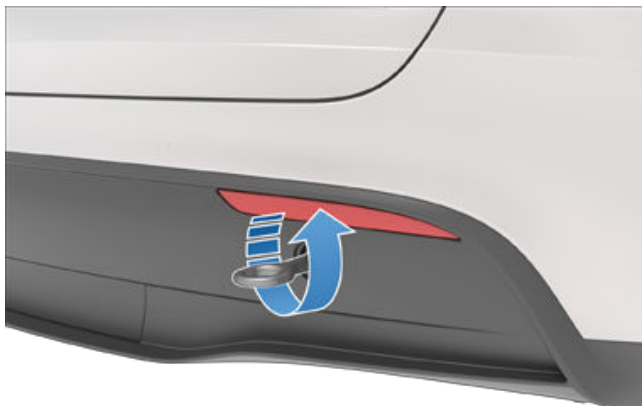

4. Attach the winch cable to the tow eye.

CAUTION: Before pulling, make sure the tow eye is securely tightened.

5. Activate Transport Mode.
6. Pull Model Y slowly onto the flatbed truck.

Secure the Tires

The vehicle's tires must be secured onto the truck using the eight-point tie-down method:

- Ensure any metal parts on the tie-down straps do not contact painted surfaces or the face of the wheels.
- Do not place tie-down straps over the body panels or through the wheels.

CAUTION: Attaching the tie-down straps to the chassis, suspension or other parts of the vehicle's body may cause damage.



If Vehicle Has No Power

If Model Y has no low voltage power, perform the following steps to open the hood or jump start the low voltage battery.

1. Open the hood. See [Opening the Hood with No Power on page 222](#) for more information on opening the hood if the vehicle does not have power.
2. Jump start the low voltage battery (see [Jump Starting on page 223](#)).

NOTE: Tow providers: See [Running Out of Range on page 221](#) for more information on transporting the vehicle to a charging station and preparing the vehicle to charge.

CAUTION: Because the windows automatically lower slightly when you open or close a door, always connect to an external, low voltage power supply before opening a door if the vehicle has no power to avoid breaking a window (see [Jump Starting on page 223](#)).



Contacting Tesla Roadside Assistance

Tesla Roadside Assistance is available to you 24 hours a day, 365 days a year, for the duration of your warranty period. Tesla Roadside Assistance is also available to speak with roadside service professionals to answer any questions and explain the proper procedure for transporting your vehicle.

When contacting Tesla Roadside Assistance, please provide:

- The Vehicle Identification Number (VIN). The VIN is displayed when you touch **Controls** > **Software**. The VIN can also be seen by looking through the driver's side of the windshield.
- Your exact location.
- The nature of the problem.

If available in your region, you can also expedite your request, by choosing the Roadside Assistance option in the Tesla mobile app.

NOTE: For a detailed description of Tesla's Roadside Assistance policy, go to the support page on the Tesla web site for your region.

Regional Phone Number(s)

New Zealand: [0800-005431](tel:0800-005431)

NOTE: The phone number is also available by touching **Controls** > **Service**.



⚠ CAUTION: It is your responsibility to monitor the state of the high voltage Battery and the remaining range of your vehicle. Do not assume that there is any range available when the range displayed on the touchscreen is at 0 km (or 0%). Damage to the low voltage battery due to running out of range is not covered by the warranty.

NOTE: In the unlikely event your vehicle runs out of range while driving, pull over when safe to do so and contact [Tesla Roadside Assistance on page 220](#) or your preferred tow provider.

If Model Y runs out of range, the low voltage battery is no longer supported – and when low voltage is not supported, the vehicle cannot charge. Therefore, the low voltage battery must be supported by an external power supply to allow you to charge the High Voltage (HV) Battery. Once the vehicle begins charging, the external power supply is no longer required.

In the case of running out of range away from a charger, the tow provider should transport Model Y to the nearest charging station and unload the vehicle within the charging cable's reach. Once the vehicle is positioned next to a charger, follow these instructions:

NOTE: If the vehicle is being transported to a charger, make sure the tow provider does not leave until confirming that the vehicle's high voltage Battery is successfully charging.

1. Jump start the low voltage system (see [Jump Starting on page 223](#)). The low voltage battery must be jump started to support the high voltage Battery.
2. Wait a few minutes. Once the touchscreen powers on, plug the charge cable into Model Y to begin charging the high voltage Battery.
3. When Model Y begins to charge, disconnect the external power supply from the low voltage battery.

Before transporting to a non-Tesla charger, ensure your vehicle is equipped with an adapter that accommodates the specific type of charging station you will be using. Even at a non-Tesla charger, you will need to jump start the low voltage system before you can begin charging.

⚠ CAUTION: Always ensure Model Y has enough range for your drive, or for being stored for an extended period. Do not rely on the range estimates displayed on the touchscreen or mobile app as range can decrease faster than projected due to ambient temperature, driving habits, wind, vehicle settings (such as Sentry Mode), etc.

NOTE: Towing your vehicle as a result of running out of range is not covered by the warranty.



Opening the Hood with No Power

Opening the Hood with No Power

In the unlikely event that Model Y has no low voltage power, you will be unable to open the front trunk using the touchscreen, key fob, or mobile app. To open the front trunk in this situation:

NOTE: The following steps do not open the front trunk if Model Y is locked and has low voltage power.

1. Locate an external low voltage power supply (such as a portable jump starter).
2. Release the tow eye cover by pressing firmly on the top right perimeter of the cover until it pivots inward, then gently pulling the raised section toward you.

NOTE: The tow eye cover is connected to the vehicle's black negative (-) terminal.



3. Pull the two wires out of the tow eye opening to expose both terminals.

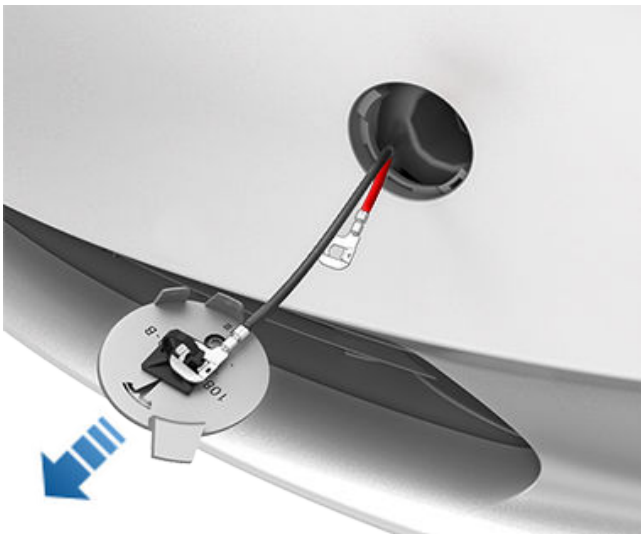

4. Connect the low voltage power supply's red positive (+) cable to the red positive (+) terminal.
5. Connect the low voltage power supply's black negative (-) cable to the black negative (-) terminal.



NOTE: Applying external low voltage power to these terminals only releases the hood latches. You cannot charge the low voltage battery using these terminals. Do not leave the low voltage power cables connected to the terminals for more than 30 seconds – remove from the vehicle's terminals as soon as the hood latches.

6. Turn on the external power supply (refer to the manufacturer's instructions). The hood latches are immediately released and you can now open the hood to access the front trunk area.
7. Disconnect both cables, beginning with the black negative (-) cable.
8. If pulling the vehicle onto a flatbed truck, do not replace the tow eye cover yet. If necessary, install the tow eye cover by inserting the wires into the tow eye opening and aligning the tow eye cover into position and snapping it into place.

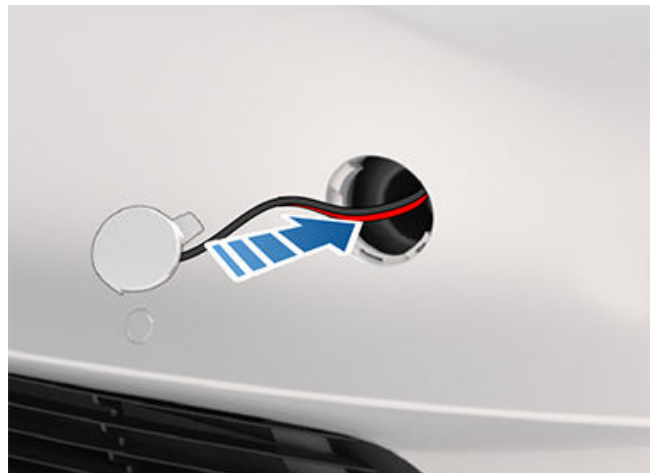



The procedure for jump starting differs depending on whether the low voltage battery is lead-acid or lithium-ion. To determine which battery your vehicle uses, touch **Controls** > **Software** > **Additional Vehicle Information**. Both procedures are provided in this section.

The following instructions assume you are using an external low voltage power supply (such as a portable jump starter). If jump starting Model Y using another vehicle, refer to the vehicle manufacturer's instructions.

CAUTION: Model Y cannot be used to jump start another vehicle. Doing so can result in damage.

CAUTION: Avoid short circuits when jump starting Model Y. Connecting cables to the wrong jump post, touching leads together, etc., can damage Model Y.

Jump Starting the Low Voltage (Lead-Acid) Battery

Vehicles manufactured in Gigafactory Shanghai before approximately October 2021, and in the Fremont Factory before approximately December 2021, are equipped with a Lead-Acid low voltage battery.

If jump starting Model Y using another vehicle, refer to that vehicle manufacturer's instructions. The following instructions assume you are using an external low voltage power supply (such as a portable jump starter).

1. Open the hood (see [Opening the Hood with No Power on page 222](#)).
2. Remove the maintenance panel by pulling it upwards to release the trim clips that hold it in place.
3. If equipped with a HEPA filter, carefully fold the HEPA filter gasket towards the front of the vehicle to gain access to the low voltage battery.

NOTE: Space to access the low voltage battery is limited. Consider removing the push clips from the rear cowl to improve accessibility.

4. Connect the low voltage power supply's red positive (+) cable to the red positive (+) terminal on the low voltage battery.
 - CAUTION:** To avoid damaging Model Y, do not allow the positive cable to contact other metal components, such as the battery tie-down bracket.
5. Connect the low voltage power supply's black negative (-) cable to the black negative (-) terminal on the low voltage battery.
6. Turn on the external power supply (refer to the manufacturer's instructions). Touch the touchscreen to wake it up.

NOTE: It may take several minutes to receive enough power to wake up the touchscreen.

7. When external low voltage power is no longer required, disconnect both cables from the terminals on the battery, beginning with the black negative (-) cable.
8. Reinstall the cabin intake trim panel by placing it back in its original location and pressing down until it is secure.
9. Replace the maintenance panel by placing it back in its original location and pressing down until it is secure.
10. Close the hood.

Jump Starting the Low Voltage (Lithium-Ion) Battery

Vehicles manufactured in Gigafactory Shanghai after approximately October 2021, and in the Fremont Factory after approximately December 2021, are equipped with a Lithium-Ion low voltage battery.

1. Open the hood (see [Opening the Hood with No Power on page 222](#)).
2. Remove the maintenance panel by pulling it upwards to release the trim clips that hold it in place.
3. If equipped with a HEPA filter, carefully fold the HEPA filter gasket towards the front of the vehicle to gain access to the low voltage jump post.

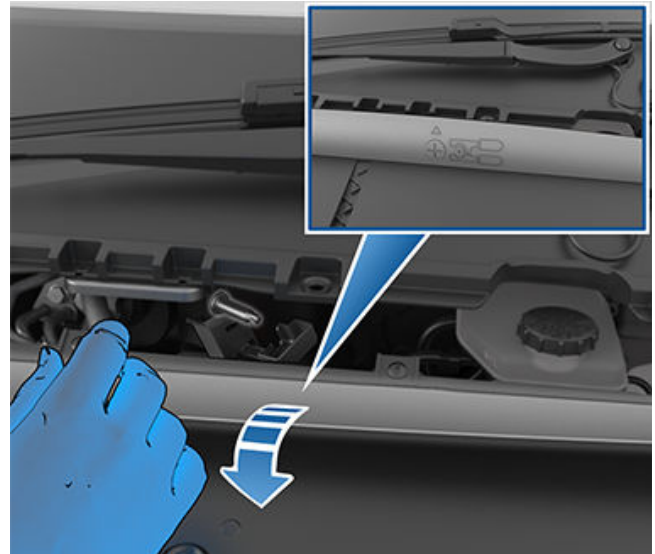

4. Pull back the black seal to reveal the positive jump post. Remove the red cover and connect the external low voltage power supply's red positive (+) cable to the red positive (+) jump post.

CAUTION: To avoid damaging the vehicle, do not allow the positive cable to contact other metal components.



Jump Starting

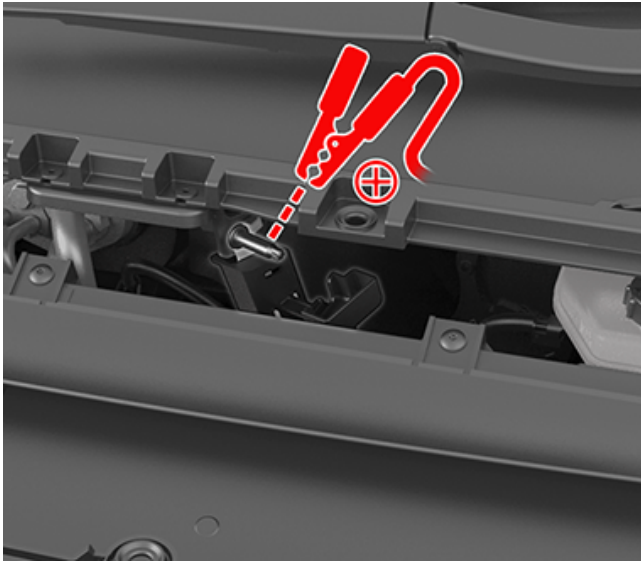

5. The HEPA filter bolt (shown below) serves as the negative (-) jump post. Connect the low voltage power supply's black negative (-) cable to the black negative HEPA jump post.

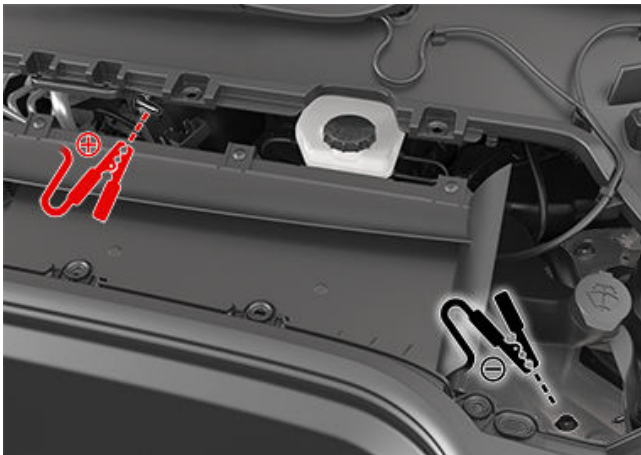

6. Turn on the external power supply (refer to the manufacturer's instructions) for 20 seconds only, then switch off or disconnect the power supply.

⚠ CAUTION: If you leave the power supply on for longer than 20 seconds, the low voltage battery may not self-recover and the vehicle might not be able to shift into Drive. If this occurs, after disconnecting the power supply, disconnect the low voltage battery, then reconnect the low voltage battery to enable another battery self-recovery attempt.

NOTE: If attempting to activate Transport Mode (to winch the vehicle onto a flatbed truck), the low voltage battery is not required to self-recover. Leave the power supply connected continuously until the vehicle has been secured.

7. Open the driver door and wait two minutes.
8. Ensure the vehicle is able to shift into Drive.

9. Replace the maintenance panel by placing it back in its original location and pressing down until it is secure.
10. Close the hood.



Opening a Front Door with No Power

To open a front door in the unlikely situation when Model Y has no power, pull up the manual door release located in front of the window switches.



1. Remove the mat from the bottom of the rear door pocket.
2. Press the red tab to remove the access door.
3. Pull the mechanical release cable forward.

! **CAUTION:** Manual door releases are designed to be used only in situations when Model Y has no power. When Model Y has power, use the button located at the top of the interior door handle.

Opening a Rear Door with No Power

You can open a rear door manually (if equipped) in the unlikely situation in which Model Y has no power:

NOTE: Not all Model Y vehicles are equipped with a manual release for the rear doors.

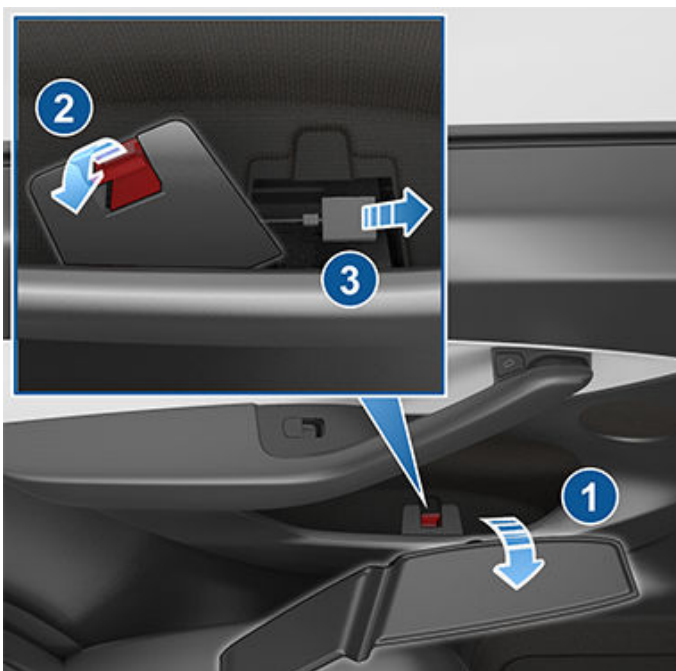



APP_w009

Automatic Emergency Braking is unavailable Feature may be restored on next drive

What this alert means:

The Automatic Emergency Braking feature is unavailable for the rest of your current drive. This alert does not specifically indicate any other braking functions or features are unavailable.

This alert may be present for several reasons. Other alerts may be present for conditions that also cause Automatic Emergency Braking to be unavailable.

What to do:

No action is typically required. Automatic Emergency Braking will usually be available again when you start your next drive.

If this alert persists across multiple drives, or occurs with increasing frequency over several drives, it is recommended that you schedule service at your earliest convenience.

For more information, see [Collision Avoidance Assist on page 137](#).

APP_w048

Autopilot features temporarily unavailable Features may be restored on next drive

What this alert means:

Autopilot features are currently unavailable on your vehicle. Depending on the configuration of your vehicle, Autopilot features that are disabled may include:

- Autosteer
- Traffic-Aware Cruise Control
- Automatic Emergency Braking
- Forward Collision Warning
- Lane Departure Warning

What to do:

This alert can be set for several reasons. Check for additional alerts that indicate the cause of this condition.

Typically, Autopilot features are restored on your next drive. If this alert persists across multiple drives, schedule service at your earliest convenience.

For more information and the full list of Autopilot features, see [About Autopilot on page 106](#).

APP_w207

Autosteer temporarily unavailable

What this alert means:

Autosteer is temporarily unavailable. This could be a temporary condition caused by an external factor, such as:

- Missing or faded lane markers.
- Narrow or winding roads.
- Poor visibility due to rain, snow, fog, or other weather.



- Extremely hot or cold temperatures.
- Bright light due to other vehicle headlights, direct sunlight, or other light sources.

This alert will also be present if you exceeded the maximum speed limit for Autosteer with Autosteer active. In this case, Autosteer will not be available for the rest of your current drive.

What to do:

Continue to your destination. If Autosteer is not available by the time you reach your destination, and remains unavailable during your next planned drive, check for the following:

- Damage or obstruction caused by mud, ice, snow, or other environmental factors
- Obstruction caused by an object mounted on the vehicle, like a bike rack
- Obstructions caused by adding paint or adhesive products like wraps, stickers, or rubber coatings to your vehicle
- A damaged or misaligned bumper

If there are no obvious obstructions, or if you find damage to the vehicle, schedule service at your convenience. Your vehicle is OK to drive in the meantime.

For more information, see [Autopilot Features on page 108](#).

APP_w218

Autosteer speed limit exceeded Take control of steering wheel

What this alert means:

Autosteer is unavailable because your vehicle has exceeded the maximum speed limit for this driver assistance feature.

What to do:

Take immediate control of the steering wheel and maintain control until you reach your destination.

In most cases, Autosteer will not be available for the rest of your current drive. To reset it, bring the vehicle to a complete stop and shift into Park. When you shift into Drive to travel to your next destination, Autosteer should be available again.

NOTE: If this alert becomes active while you are driving in Germany, Autosteer should be available again once your vehicle is traveling below the Autosteer speed limit.

If Autosteer is not available during your next drive, and remains unavailable throughout subsequent drives, schedule service at your convenience. Your vehicle is OK to drive in the meantime.

For more information, see [Autopilot Features on page 108](#).

APP_w222

Cruise control unavailable Reduced front camera visibility

What this alert means:

Traffic-Aware Cruise Control and Autosteer are unavailable because one or more of the front cameras in your vehicle is blocked or blinded by external conditions.

Traffic-Aware Cruise Control and Autosteer will remain unavailable while a front camera lacks adequate visibility. Cameras may have limited or no visibility due to:

- Dirt or debris on the camera surface.
- Environmental conditions like rain, fog, snow, or dew.



Troubleshooting Alerts

- Bright sunlight or glare from another light source.
- Low or limited light conditions, including unlit or poorly lit roadways at night.
- Condensation (water droplets or mist) on the camera surface.
- Monotonous environmental features, including tunnel walls or highway dividers.

What to do:

Continue to your destination. Your vehicle is OK to drive.

This is often a temporary issue that clears up on its own. If the alert does not clear by the end of your drive:

- Inspect and clean the front camera area at the top center of the windshield before your next planned drive.
- Check the camera surface for condensation, dirt, or other debris and attempt to clear any obstruction.

See [Cleaning a Camera on page 192](#) for more information on clearing dirt or debris from that area of the vehicle.

Although condensation on the inside of the front camera enclosure cannot be wiped clean, you can usually clear it quicker by following these steps:

1. Pre-condition the cabin with the temperature set to High and A/C turned ON.
2. Turn on the front windshield defroster.

If this alert persists throughout subsequent drives but no front camera obstruction is visible, schedule service at your earliest convenience. Your vehicle is OK to drive in the meantime.

APP_w224

Cruise control unavailable

Continue driving to allow cameras to calibrate

What this alert means:

Traffic-Aware Cruise Control and Autosteer are unavailable because the cameras on your vehicle are not fully calibrated.

Your vehicle must maneuver with great precision when features like Traffic-Aware Cruise Control and Autosteer are active. Before these features can be used for the first time, the cameras must complete an initial self-calibration. Occasionally, one or more cameras can become uncalibrated.

What to do:

Continue to your destination. Your vehicle is OK to drive.

Traffic-Aware Cruise Control and Autosteer will remain unavailable until camera calibration is complete.

When calibration is complete, Traffic-Aware Cruise Control and Autosteer should be available.

For your convenience, a calibration progress indicator is displayed on the touchscreen. Calibration typically completes after your vehicle has driven 20–25 miles (32–40 km), but the distance varies depending on road and environmental conditions. For example, driving on a straight road with highly visible lane markings helps the cameras calibrate quicker.

If the alert persists and camera calibration has not completed after your vehicle has driven 100 miles (160 km) or more, or Traffic-Aware Cruise Control and Autosteer remain unavailable despite successful camera calibration, schedule service at your earliest convenience. Your vehicle is OK to drive in the meantime.

APP_w304

Camera blocked or blinded

Clean camera or wait for it to regain visibility

What this alert means:



One or more of the vehicle cameras has limited visibility, or no visibility at all, due to external conditions. When the cameras on your vehicle cannot provide accurate visual information, some or all Autopilot features may be temporarily unavailable.

Cameras may have limited or no visibility due to:

- Dirt or debris on the camera surface.
- Environmental conditions like rain, fog, snow, or dew.
- Bright sunlight or glare from another light source.
- Low or limited light conditions, including unlit or poorly lit roadways at night.
- Condensation (water droplets or mist) on the camera surface.
- Monotonous environmental features, including tunnel walls or highway dividers.

What to do:

Continue to your destination. Your vehicle is OK to drive. This is often a temporary issue that will be resolved when condensation evaporates, or when a particular environmental condition or feature is no longer present.

If the alert does not clear by the time you reach your destination, check camera surfaces for condensation, dirt, or other debris. For camera locations, see [Cameras on page 16](#).

Clean the cameras as necessary before your next planned drive. For recommended cleaning procedures, see [Cleaning a Camera on page 192](#).

If you continue to see this alert after cleaning the cameras, check the inside surfaces of the door pillar camera enclosures for condensation. Although condensation inside the camera enclosures cannot be wiped clean, you can usually clear it faster by following these steps:

1. Precondition the cabin by turning Climate ON, setting temperature to High, and making sure A/C is ON.
2. Turn on the front windshield defroster.
3. Direct the air vents toward the door pillar cameras.

For more information on clearing condensation from camera enclosures, see [Cleaning a Camera on page 192](#).

If the alert does not clear by the end of your next planned drive, despite cleaning the indicated camera(s) and following recommended steps to clear condensation, schedule service at your next convenient opportunity. Your vehicle is OK to drive in the meantime.

BMS_a067

High voltage battery performance limited OK to drive - Schedule service soon

What this alert means:

Your vehicle has detected a condition internal to the high voltage battery that is limiting the battery's performance. Service is required to restore full performance.

Your vehicle's maximum range may be reduced, and your vehicle may take longer to charge than before. Maximum charge rate varies, as always, based on location, power source, and charging equipment.

What to do:

Your vehicle is OK to drive.

It is recommended that you schedule service at your earliest convenience. Without service, your vehicle may continue to show further reductions in maximum range and charging performance and may also begin to show reduced power and acceleration when driving.

While this alert remains present, keep your vehicle charged to 30% capacity or higher to avoid any discrepancy between the estimated range displayed on your vehicle's touchscreen and the actual high voltage battery charge level.



Troubleshooting Alerts

For more information on the high voltage battery, see [High Voltage Battery Information on page 171](#).

BMS_a068

High voltage battery requires service Acceleration and charging performance reduced

What this alert means:

Your vehicle has detected a condition internal to the high voltage battery that is limiting the battery's performance.

You may notice that your vehicle's top speed is reduced and it responds slower than previously to acceleration requests.

Your vehicle's maximum range may be reduced, and your vehicle may take longer to charge than before. Maximum charge rate varies, as always, based on location, power source, and charging equipment.

Service is required to restore full performance.

What to do:

Your vehicle is OK to drive.

It is recommended that you schedule service at your earliest opportunity. Without service, your vehicle may continue to show reduced power, acceleration, range, and charging performance.

While this alert remains present, keep your vehicle charged to 30% capacity or higher to avoid any discrepancy between the estimated range displayed on your vehicle's touchscreen and the actual high voltage battery charge level.

For more information on the high voltage battery, see [High Voltage Battery Information on page 171](#).

BMS_a069

Battery charge level low Charge now

What this alert means:

Your vehicle has detected that the high voltage battery does not have enough energy remaining to support driving. This alert is usually present because your vehicle's high voltage battery charge level has been reduced through normal operation.

Your vehicle will be unable to drive or continue driving until charged.

If this alert is present while you are driving, your vehicle needs to shut down. A separate vehicle alert should be present to indicate this condition. It is also possible your vehicle may shut down unexpectedly.

If this alert is present when your vehicle is parked, you may be unable to drive.

What to do:

Charge your vehicle immediately. Charging your vehicle should restore your vehicle's ability to drive.

If this alert occurs during subsequent drives, despite a displayed battery charge level of 5% or higher, schedule service at your earliest convenience.

For more information on the high voltage battery, see [High Voltage Battery Information on page 171](#).

For more information on charging, see [Charging Instructions on page 173](#). BMS_a074



BMS_a074

Maximum battery charge level reduced OK to drive - Schedule service

What this alert means:

Your vehicle has detected a condition internal to the high voltage battery that is limiting the battery's performance. As a result, maximum charge level and range is reduced. Service is required to restore full performance.

What to do:

- Your vehicle is OK to drive. Your vehicle is able to charge when the state of charge is below 50%. Charging will not start if the State of Charge is already above 50%.
- If this alert persists, schedule service at your earliest convenience. Without service, you may notice further reductions in your vehicle's maximum charge level and range.
- For more information on the high voltage battery, see

BMS_a079

Unable to charge - Maximum charge level reached Reduced maximum charge level - Schedule service

What this alert means:

Your vehicle has detected a condition internal to the high voltage battery that is limiting the battery's ability to charge 50% of State of Charge.

What to do:

- Your vehicle is OK to drive. Your vehicle is able to charge when the state of charge is below 50%. Charging will not start if the State of Charge is already above 50%.
- If this alert persists, schedule service at your earliest convenience. Without service, you may notice further reductions in your vehicle's maximum charge level and range.
- For more information on the high voltage battery, see

CC_a001

Unable to charge - Insufficient grounding Proper wiring or outlet grounding must be verified

What this alert means:

No ground connection detected in the Wall Connector.

What to do:

Have the Wall Connector inspected by an electrician to make sure it is properly grounded. Your electrician should ensure there is proper grounding at your circuit breaker or power distribution box and also ensure that appropriate connections are made to the Wall Connector.

For more information, see the [installation guide](#) for your Wall Connector.

CC_a002

Unable to charge - Insufficient grounding Disconnect and retry or use different equipment

What this alert means:



Troubleshooting Alerts

Ground fault. Current is leaking through an unsafe path. Possible Line to ground or Neutral to ground fault.

What to do:

Try charging again by disconnecting the Wall Connector from the vehicle and reconnecting. If the issue persists, turn OFF the circuit breaker servicing the Wall Connector, wait 10 seconds, turn the circuit breaker ON again, then try reconnecting the Wall Connector to the vehicle. If the issue persists, consult your electrician or contact Tesla.

For more information, see the [installation guide](#) for your Wall Connector.

CC_a003

Unable to charge - Wall Connector GFCI tripped Disconnect and retry or use different equipment

What this alert means:

Ground fault. Current is leaking through an unsafe path. Possible Line to ground or Neutral to ground fault.

What to do:

Try charging again by disconnecting the Wall Connector from the vehicle and reconnecting. If the issue persists, turn OFF the circuit breaker servicing the Wall Connector, wait 10 seconds, turn the circuit breaker ON again, then try reconnecting the Wall Connector to the vehicle. If the issue persists, consult your electrician or contact Tesla.

For more information, see the [installation guide](#) for your Wall Connector.

CC_a004

Unable to charge - Wall Connector issue Wall Connector needs service

What this alert means:

Wall Connector hardware issue. Possible issues include:

1. Contactor not working
2. Self-test of internal ground fault monitoring circuit failed
3. Thermal sensor disconnected
4. Other hardware component issues

What to do:

An internal issue was detected by the Wall Connector.

1. Try charging again by disconnecting the Wall Connector from the vehicle and reconnecting.
2. If the issue persists, turn OFF the circuit breaker for the Wall Connector, wait 10 seconds, and turn the circuit breaker ON again. Then try reconnecting the Wall Connector to the vehicle.
3. If the issue persists, have an electrician make sure all wires are properly connected and torqued according to the instructions in the Wall Connector Installation Manual.
4. Once your electrician has completed all work and restored power to the Wall Connector, try charging again by reconnecting the Wall Connector to the vehicle.
5. If the issue persists, the Wall Connector requires service.

For more information, see the [installation guide](#) for your Wall Connector.



CC_a005

Unable to charge - Wall Connector GFCI tripped Disconnect and retry or use different equipment

What this alert means:

Ground fault. Current is leaking through an unsafe path. Possible Line to ground or Neutral to ground fault.

What to do:

Try charging again by disconnecting the Wall Connector from the vehicle and reconnecting. If the issue persists, turn OFF the circuit breaker servicing the Wall Connector, wait 10 seconds, turn the circuit breaker ON again, then try reconnecting the Wall Connector to the vehicle. If the issue persists, consult your electrician or contact Tesla.

For more information, see the [installation guide](#) for your Wall Connector.

CC_a006

Unable to charge - Wall Connector overcurrent Disconnect and retry or use different equipment

What this alert means:

Over current protection.

What to do:

Reduce the vehicle's charge current setting. If the issue persists, service is required.

For more information, see the [installation guide](#) for your Wall Connector.

CC_a007

Unable to charge - Input voltage too high Voltage must be within Wall Connector rating

What this alert means:

Over or under voltage protection.

What to do:

Consult your electrician to ensure appropriate voltage on the circuit breaker that services the Wall Connector.

For more information, see the [installation guide](#) for your Wall Connector.

CC_a008

Unable to charge - Input voltage too low Voltage must be within Wall Connector rating

What this alert means:

Over or under voltage protection.

What to do:

Consult your electrician to ensure appropriate voltage on the circuit breaker that services the Wall Connector.

For more information, see the [installation guide](#) for your Wall Connector.



CC_a009

Unable to charge - Input wired incorrectly Input wiring to Wall Connector must be corrected

What this alert means:

Input miswired: possibly Line and Neutral are swapped.

What to do:

The wiring between the wall power and the Wall Connector has been incorrectly installed. Consult your electrician.

For more information, see the [installation guide](#) for your Wall Connector.

CC_a010

Unable to charge - Wall Connector issue Wall Connector needs service

What this alert means:

Wall Connector hardware issue. Possible issues include:

1. Contactor not working
2. Self-test of internal ground fault monitoring circuit failed
3. Thermal sensor disconnected
4. Other hardware component issues

What to do:

An internal issue was detected by the Wall Connector.

1. Try charging again by disconnecting the Wall Connector from the vehicle and reconnecting.
2. If the issue persists, turn OFF the circuit breaker for the Wall Connector, wait 10 seconds, and turn the circuit breaker ON again. Then try reconnecting the Wall Connector to the vehicle.
3. If the issue persists, have an electrician make sure all wires are properly connected and torqued according to the instructions in the Wall Connector Installation Manual.
4. Once your electrician has completed all work and restored power to the Wall Connector, try charging again by reconnecting the Wall Connector to the vehicle.
5. If the issue persists, the Wall Connector requires service.

For more information, see the [installation guide](#) for your Wall Connector.

CC_a011

Unable to charge - Wall Connector too hot Let Wall Connector cool and try again

What this alert means:

Over temperature protection (latchoff).

What to do:

Make sure the Wall Connector is not covered by anything and that there is no heat source nearby. If the problem persists in normal ambient temperatures (under 38°C), service is required.

For more information, see the [installation guide](#) for your Wall Connector.



CC_a012

Unable to charge - Wall connection too hot Outlet or Wall Connector wiring must be checked

High temperature detected by Wall Connector alerts indicate the building connection to the Wall Connector is getting too warm, so charging has stopped to protect the wiring and Wall Connector.

This is not typically an issue with your vehicle or your Wall Connector, but rather an issue with the building wiring. This may be caused by a loose building wiring connection to the Wall Connector and can be fixed quickly by an electrician.

To regain normal charge operation, try the following steps.

If the Wall Connector is plugged into a wall outlet, make sure:

- The plug is fully inserted into the receptacle / outlet
- The plug / outlet area is not blocked or covered by anything
- There is no heat source nearby

If the issue persists or the Wall Connector is hard-wired, contact an electrician to inspect the building wiring connection to the Wall Connector. They should make sure that all wires are properly connected and torqued according to the installation guide for the Wall Connector.

For more information, see the [installation guide](#) for your Wall Connector.

CC_a013

Unable to charge - Charge handle too hot Check charge handle or charge port for debris

What this alert means:

Over temperature protection (latchoff).

What to do:

Make sure the connector is fully inserted into the charge inlet in the vehicle's charging port, is not covered by anything, and there is no heat source nearby. If the issue persists in normal ambient temperatures (under 38°C), service is required.

For more information, see the [installation guide](#) for your Wall Connector.

CC_a014

Unable to charge - Wall Connector issue Wall Connector needs service

What this alert means:

Wall Connector hardware issue. Possible issues include:

1. Contactor not working
2. Self-test of internal ground fault monitoring circuit failed
3. Thermal sensor disconnected
4. Other hardware component issues

What to do:

An internal issue was detected by the Wall Connector.



Troubleshooting Alerts

1. Try charging again by disconnecting the Wall Connector from the vehicle and reconnecting.
2. If the issue persists, turn OFF the circuit breaker for the Wall Connector, wait 10 seconds, and turn the circuit breaker ON again. Then try reconnecting the Wall Connector to the vehicle.
3. If the issue persists, have an electrician make sure all wires are properly connected and torqued according to the instructions in the Wall Connector Installation Manual.
4. Once your electrician has completed all work and restored power to the Wall Connector, try charging again by reconnecting the Wall Connector to the vehicle.
5. If the issue persists, the Wall Connector requires service.

For more information, see the [installation guide](#) for your Wall Connector.

CC_a015

Unable to charge - Vehicle connection issue

Insert charge handle fully into charge port

What this alert means:

A communication error occurred between the Wall Connector and the vehicle.

What to do:

Try charging again by disconnecting the Wall Connector from the vehicle and reconnecting.

1. If the issue persists, turn OFF the circuit breaker servicing the Wall Connector, wait 10 seconds, turn the circuit breaker ON again, then try reconnecting the Wall Connector to the vehicle.
2. If the issue persists and other charging equipment is available, plug the vehicle into another Wall Connector or a Mobile Connector to determine if the vehicle is able to communicate with other charging equipment.
3. If the issue persists, service is required.

For more information, see the [installation guide](#) for your Wall Connector.

CC_a016

Unable to charge - Vehicle connection issue

Insert charge handle fully into charge port

What this alert means:

A communication error occurred between the Wall Connector and the vehicle.

What to do:

Try charging again by disconnecting the Wall Connector from the vehicle and reconnecting.

1. If the issue persists, turn OFF the circuit breaker servicing the Wall Connector, wait 10 seconds, turn the circuit breaker ON again, then try reconnecting the Wall Connector to the vehicle.
2. If the issue persists and other charging equipment is available, plug the vehicle into another Wall Connector or a Mobile Connector to determine if the vehicle is able to communicate with other charging equipment.
3. If the issue persists, service is required.

For more information, see the [installation guide](#) for your Wall Connector.



CC_a017

Unable to charge - Vehicle connection issue Insert charge handle fully into charge port

What this alert means:

A communication error occurred between the Wall Connector and the vehicle.

What to do:

Try charging again by disconnecting the Wall Connector from the vehicle and reconnecting.

1. If the issue persists, turn OFF the circuit breaker servicing the Wall Connector, wait 10 seconds, turn the circuit breaker ON again, then try reconnecting the Wall Connector to the vehicle.
2. If the issue persists and other charging equipment is available, plug the vehicle into another Wall Connector or a Mobile Connector to determine if the vehicle is able to communicate with other charging equipment.
3. If the issue persists, service is required.

For more information, see the [installation guide](#) for your Wall Connector.

CC_a018

Unable to charge - Vehicle connection issue Insert charge handle fully into charge port

What this alert means:

A communication error occurred between the Wall Connector and the vehicle.

What to do:

Try charging again by disconnecting the Wall Connector from the vehicle and reconnecting.

1. If the issue persists, turn OFF the circuit breaker servicing the Wall Connector, wait 10 seconds, turn the circuit breaker ON again, then try reconnecting the Wall Connector to the vehicle.
2. If the issue persists and other charging equipment is available, plug the vehicle into another Wall Connector or a Mobile Connector to determine if the vehicle is able to communicate with other charging equipment.
3. If the issue persists, service is required.

For more information, see the [installation guide](#) for your Wall Connector.

CC_a019

Unable to charge - Vehicle connection issue Insert charge handle fully into charge port

What this alert means:

A communication error occurred between the Wall Connector and the vehicle.

What to do:

Try charging again by disconnecting the Wall Connector from the vehicle and reconnecting.

1. If the issue persists, turn OFF the circuit breaker servicing the Wall Connector, wait 10 seconds, turn the circuit breaker ON again, then try reconnecting the Wall Connector to the vehicle.
2. If the issue persists and other charging equipment is available, plug the vehicle into another Wall Connector or a Mobile Connector to determine if the vehicle is able to communicate with other charging equipment.



3. If the issue persists, service is required.

For more information, see the [installation guide](#) for your Wall Connector.

CC_a020

Unable to charge - Wall Connector issue Wall Connector needs service

What this alert means:

Wall Connector hardware issue. Possible issues include:

1. Contactor not working
2. Self-test of internal ground fault monitoring circuit failed
3. Thermal sensor disconnected
4. Other hardware component issues

What to do:

An internal issue was detected by the Wall Connector.

1. Try charging again by disconnecting the Wall Connector from the vehicle and reconnecting.
2. If the issue persists, turn OFF the circuit breaker for the Wall Connector, wait 10 seconds, and turn the circuit breaker ON again. Then try reconnecting the Wall Connector to the vehicle.
3. If the issue persists, have an electrician make sure all wires are properly connected and torqued according to the instructions in the Wall Connector Installation Manual.
4. Once your electrician has completed all work and restored power to the Wall Connector, try charging again by reconnecting the Wall Connector to the vehicle.
5. If the issue persists, the Wall Connector requires service.

For more information, see the [installation guide](#) for your Wall Connector.

CC_a021

Unable to charge - No primary Wall Connector Check that primary unit is powered and available

What this alert means:

Load sharing (circuit breaker sharing) network: Need one (and only one) Wall Connector set as primary.

What to do:

Only one Wall Connector can be set to a primary configuration. Have your electrician confirm:

1. Only one of the Wall Connectors is set as primary.
2. All other Wall Connectors linked to the primary unit are set to paired position (position F).

For more information, see the [installation guide](#) for your Wall Connector.

CC_a022

Unable to charge - More than 1 primary unit Ensure only 1 Wall Connector is set as primary

What this alert means:



Load sharing (circuit breaker sharing) network: Need one (and only one) Wall Connector set as primary.

What to do:

Only one Wall Connector can be set to a primary configuration. Have your electrician confirm:

1. Only one of the Wall Connectors is set as primary.
2. All other Wall Connectors linked to the primary unit are set to paired position (position F).

For more information, see the [installation guide](#) for your Wall Connector.

CC_a023

Unable to charge - Too many Wall Connectors Ensure no more than 3 units paired with primary

What this alert means:

Load sharing (circuit breaker sharing) network: More than three Wall Connectors are paired with the same primary unit.

What to do:

Consult your electrician to have one or more paired Wall Connectors moved to a different circuit and disconnected (unpaired) from this load sharing (circuit breaker sharing) network.

For more information, see the [installation guide](#) for your Wall Connector.

CC_a024

Unable to charge - Low Wall Connector current Primary unit current setting must be increased

What this alert means:

Incorrect rotary switch setting.

What to do:

Have your electrician adjust the Wall Connector's internal rotary switch to a valid operating current setting. They should first make sure there is no power to the Wall Connector. The correlation between switch setting and current should be printed on the inside of the Wall Connector. Your electrician should also refer to the Set the Operating Current section in the Wall Connector Installation Manual.

If the Wall Connector is set up for load sharing (circuit breaker sharing) and paired with other Wall Connectors, the rotary switch of the primary unit must be set to an operating current setting that allows each paired Wall Connector to receive at least 6A of charge current.

Example: Three Wall Connectors are paired for load sharing. The primary unit needs to be set to a current of at least $3 * 6A = 18A$ or greater.

For more information, see the [installation guide](#) for your Wall Connector.

CC_a025

Unable to charge - Wall Connector issue Wall Connector needs service

What this alert means:

Wall Connector hardware issue. Possible issues include:

1. Contactor not working



Troubleshooting Alerts

2. Self-test of internal ground fault monitoring circuit failed
3. Thermal sensor disconnected
4. Other hardware component issues

What to do:

An internal issue was detected by the Wall Connector.

1. Try charging again by disconnecting the Wall Connector from the vehicle and reconnecting.
2. If the issue persists, turn OFF the circuit breaker for the Wall Connector, wait 10 seconds, and turn the circuit breaker ON again. Then try reconnecting the Wall Connector to the vehicle.
3. If the issue persists, have an electrician make sure all wires are properly connected and torqued according to the instructions in the Wall Connector Installation Manual.
4. Once your electrician has completed all work and restored power to the Wall Connector, try charging again by reconnecting the Wall Connector to the vehicle.
5. If the issue persists, the Wall Connector requires service.

For more information, see the [installation guide](#) for your Wall Connector.

CC_a026

Unable to charge - Wall Connector issue Wall Connector needs service

What this alert means:

Wall Connector hardware issue. Possible issues include:

1. Contactor not working
2. Self-test of internal ground fault monitoring circuit failed
3. Thermal sensor disconnected
4. Other hardware component issues

What to do:

An internal issue was detected by the Wall Connector.

1. Try charging again by disconnecting the Wall Connector from the vehicle and reconnecting.
2. If the issue persists, turn OFF the circuit breaker for the Wall Connector, wait 10 seconds, and turn the circuit breaker ON again. Then try reconnecting the Wall Connector to the vehicle.
3. If the issue persists, have an electrician make sure all wires are properly connected and torqued according to the instructions in the Wall Connector Installation Manual.
4. Once your electrician has completed all work and restored power to the Wall Connector, try charging again by reconnecting the Wall Connector to the vehicle.
5. If the issue persists, the Wall Connector requires service.

For more information, see the [installation guide](#) for your Wall Connector.

CC_a027

Unable to charge - Wall Connector issue Wall Connector needs service

What this alert means:



Wall Connector hardware issue. Possible issues include:

1. Contactor not working
2. Self-test of internal ground fault monitoring circuit failed
3. Thermal sensor disconnected
4. Other hardware component issues

What to do:

An internal issue was detected by the Wall Connector.

1. Try charging again by disconnecting the Wall Connector from the vehicle and reconnecting.
2. If the issue persists, turn OFF the circuit breaker for the Wall Connector, wait 10 seconds, and turn the circuit breaker ON again. Then try reconnecting the Wall Connector to the vehicle.
3. If the issue persists, have an electrician make sure all wires are properly connected and torqued according to the instructions in the Wall Connector Installation Manual.
4. Once your electrician has completed all work and restored power to the Wall Connector, try charging again by reconnecting the Wall Connector to the vehicle.
5. If the issue persists, the Wall Connector requires service.

For more information, see the [installation guide](#) for your Wall Connector.

CC_a028

Unable to charge - Incorrect switch setting Wall Connector rotary switch must be adjusted

What this alert means:

Incorrect rotary switch setting.

What to do:

Have your electrician adjust the Wall Connector's internal rotary switch to a valid operating current setting. They should first make sure there is no power to the Wall Connector. The correlation between switch setting and current should be printed on the inside of the Wall Connector. Your electrician should also refer to the Set the Operating Current section in the Wall Connector Installation Manual.

If the Wall Connector is set up for load sharing (circuit breaker sharing) and paired with other Wall Connectors, the rotary switch of the primary unit must be set to an operating current setting that allows each paired Wall Connector to receive at least 6A of charge current.

Example: Three Wall Connectors are paired for load sharing. The primary unit needs to be set to a current of at least $3 * 6A = 18A$ or greater.

For more information, see the [installation guide](#) for your Wall Connector.

CC_a029

Unable to charge - Vehicle connection issue Insert charge handle fully into charge port

What this alert means:

A communication error occurred between the Wall Connector and the vehicle.

What to do:

Try charging again by disconnecting the Wall Connector from the vehicle and reconnecting.



Troubleshooting Alerts

1. If the issue persists, turn OFF the circuit breaker servicing the Wall Connector, wait 10 seconds, turn the circuit breaker ON again, then try reconnecting the Wall Connector to the vehicle.
2. If the issue persists and other charging equipment is available, plug the vehicle into another Wall Connector or a Mobile Connector to determine if the vehicle is able to communicate with other charging equipment.
3. If the issue persists, service is required.

For more information, see the [installation guide](#) for your Wall Connector.

CC_a030

Unable to charge - Primary / paired unit mismatch Wall Connector current ratings must match

What this alert means:

Load sharing (circuit breaker sharing) network: The paired Wall Connectors have different maximum current capabilities.

What to do:

Only Wall Connectors with the same maximum current capabilities can be paired in a load sharing (circuit breaker sharing) network. Have your electrician inspect the type labels on the Wall Connectors and make sure the current capabilities match. It is further recommended that your electrician only pair Wall Connectors with the same part number, as an easy way to make sure paired units are compatible.

For more information, see the [installation guide](#) for your Wall Connector.

CC_a041

Charge rate reduced - Wall connection hot Outlet or Wall Connector wiring must be checked

What this alert means:

High temperature detected by Wall Connector alerts indicate the building connection to the Wall Connector is getting too warm, so charging has been slowed to protect the wiring and Wall Connector.

This is not typically an issue with your vehicle or your Wall Connector, but rather an issue with the building wiring. This may be caused by a loose building wiring connection to the Wall Connector and can be fixed quickly by an electrician.

What to do:

Contact an electrician to inspect the building wiring connection to the Wall Connector. They should make sure that all wires are properly connected and torqued according to the installation guide for the Wall Connector.

For more information, see the [installation guide](#) for your Wall Connector.

CC_a043

Wall Connector configuration must be completed Refer to Installation Guide to enable charging

What this alert means:

Wall Connector configuration is incomplete.

What to do:

The Wall Connector needs to be commissioned to appropriately configure the circuit breaker size and protective earth connection type.



For more information, refer to Commissioning Procedure in the Wall Connector Installation Manual. If the issue persists, contact an electrician to inspect the building wiring connection to the Wall Connector. They should make sure the power output and grounding connections are properly configured according to the installation guide for the Wall Connector.

For more information, see the [installation guide](#) for your Wall Connector.

CP_a004

Charging equipment not recognized

Try again or try different equipment

What this alert means:

The charge port is unable to detect whether a charge cable is inserted, or the type of charge cable connected.

This alert is usually specific to external charging equipment and power sources and does not typically indicate an issue with your vehicle that can be resolved by scheduling service.

What to do:

If this alert appears while a charge cable **is** connected, determine whether the issue is caused by the charging equipment or the vehicle. Try charging the vehicle using different external charging equipment (including charge cable, charging station, or charging stall).

- If the vehicle begins charging, the issue was likely with the equipment.
- If the vehicle still does not charge, the issue may be with the vehicle.

If this alert appears while a charge cable is **not** connected or if the issue is suspected to be with the vehicle, inspect the charge port inlet and the charge cable connector for any obstructions, such as debris, moisture, and/or foreign objects. Make sure any charge port inlet obstruction has been removed and any moisture has been allowed to dry, then try re-inserting the cable into the charge port.

You can also try charging your vehicle using a Tesla Supercharger or Destination Charging location, all of which can be located through the map on your vehicle's touchscreen display. See [Maps and Navigation on page 159](#) for more details.

For more information on troubleshooting Mobile Connector or Wall Connector status lights, refer to the product's Owner's Manual at [Charging & Adapter Product Guides](#).

For more information on charging, see [Charging Instructions on page 173](#).

CP_a010

Charging equipment communication error

Try again or try different equipment

What this alert means:

Your vehicle is unable to charge because it cannot communicate effectively with the external charging equipment. It cannot sense a valid control pilot signal coming from the charging equipment.

This alert is usually specific to external charging equipment and power sources and does not typically indicate an issue with your vehicle that can be resolved by scheduling service.

What to do:

First, confirm the lack of effective communication is caused by the external charging equipment rather than an issue with your vehicle. This is usually the case.

Try charging the vehicle using different external charging equipment (including charge cable, charging station, or charging stall).

- If the vehicle begins charging, the issue was likely with the equipment.



Troubleshooting Alerts

- If the vehicle still does not charge, the issue may be with the vehicle.

If the issue is suspected to be with the vehicle, inspect the charge port inlet and the charge cable connector for any obstructions, such as debris, moisture, and/or foreign objects. Make sure any charge port inlet obstruction has been removed and any moisture has been allowed to dry, then try re-inserting the cable into the charge port.

You can also try charging your vehicle using a Tesla Supercharger or Destination Charging location, all of which can be located through the map on your vehicle's touchscreen display. See [Maps and Navigation on page 159](#) for more details.

For more information on troubleshooting Mobile Connector or Wall Connector status lights, refer to the product's Owner's Manual at [Charging & Adapter Product Guides](#).

For more information on charging, see [Charging Instructions on page 173](#).

CP_a043

Charge port door sensor fault

Charge port may not operate as expected

What this alert means:

One of the charge port door sensors is not functioning normally. When this occurs, the charge port may be unable to accurately sense the charge port door position and the charge port may not operate as expected.

- The charge port latch may intermittently remain engaged when the charge port door is opened.
- The charge port light may illuminate only intermittently when the charge port door is opened.

What to do:

Try closing the charge port door and then opening it again.

For more information, see [Opening the Charge Port on page 173](#).

For more information on charging, see [Charging Instructions on page 173](#).

CP_a046

Charging equipment communication lost

Check power source and charging equipment

What this alert means:

Charging stopped because communication between the vehicle and the external charging equipment was interrupted.

This alert is usually specific to external charging equipment and power sources and does not typically indicate an issue with your vehicle that can be resolved by scheduling service.

What to do:

Confirm whether the external charging equipment is powered by looking for any status lights, displays, or other indicators on the equipment.

If the equipment is **not** powered, try to restore the external charging equipment's power source.

- If attempting to charge at a public station and power is unable to be restored, contact the station operator.
- If attempting to charge at a private station (for example: charging at home) and power is unable to be restored, contact an electrician.

If the equipment is powered, try charging the vehicle using different external charging equipment.

- If the vehicle begins charging, the issue was likely with the equipment.



- If the vehicle still does not charge, the issue may be with the vehicle.

You can also try charging your vehicle using a Tesla Supercharger or Destination Charging location, all of which can be located through the map on your vehicle's touchscreen display. See [Maps and Navigation on page 159](#) for more details.

For more information on troubleshooting Mobile Connector or Wall Connector status lights, refer to the product's Owner's Manual at [Charging & Adapter Product Guides](#).

CP_a051

Charge port may not open when pressed Use another method to open the charge port

What this alert means:

One of the charge port door sensors is not communicating properly. The charge port may not recognize the request to open when the charge port door is pressed.

What to do:

You can still use all other usual methods to open the charge port door:

- Use the vehicle touchscreen.
- Use the Tesla Mobile App.
- With your vehicle unlocked, press the charge handle button on any Tesla charge cable, including a Wall Connector, Mobile Connector, or Supercharger.
- Hold and press the trunk button on your key fob.

For more information, see [Opening the Charge Port on page 173](#).

CP_a053

Unable to charge - Charge station not powered Check power source or try a different station

What this alert means:

Charging cannot begin because the charging equipment is not ready. A charge handle is detected, but the charging station is not communicating with the vehicle. This issue could occur because:

- The charging station is not powered.
- The control pilot signal between the charging station and the vehicle is interrupted.

This alert is usually specific to external charging equipment and power sources and does not typically indicate an issue with your vehicle that can be resolved by scheduling service.

What to do:

Try charging the vehicle with different charging equipment or at a different charging station.

- If the vehicle begins charging, the issue was likely with the equipment.
- If the vehicle still does not charge, the issue may be with the vehicle.

If using a Mobile Connector or Wall Connector, first check the status lights on the front. If no status lights are visible, check the power source and contact an electrician to inspect the building wiring connection to the wall outlet or the Wall Connector to confirm that all wires are properly connected and torqued.

If using other external charging equipment, consult the product's owner's manual to learn how to confirm that the station is powered. Contact an electrician to inspect the building wiring and charging equipment as necessary.



Troubleshooting Alerts

For more information on troubleshooting Mobile Connector or Wall Connector status lights, refer to the product's Owner's Manual at [Charging & Adapter Product Guides](#).

You can also try charging your vehicle using a Tesla Supercharger or Destination Charging location, all of which can be located through the map on your vehicle's touchscreen display. See [Maps and Navigation on page 159](#) for more details.

CP_a054

Charge port latch not engaged

Fully insert charge cable or check for obstruction

What this alert means:

The charge port latch is unable to latch the charge cable in the charge port inlet. If the latch is not engaged, AC charging (for example, charging with a Mobile Connector or Wall Connector) will be limited to 16A and DC Fast Charging / Supercharging will be unavailable.

The charge port light will pulse amber if this alert appears during AC charging and will be solid amber if this alert appears when attempting to DC Fast Charge / Supercharge.

This alert is usually specific to external charging equipment and power sources and does not typically indicate an issue with your vehicle that can be resolved by scheduling service.

What to do:

Try re-inserting the charge cable fully into the charge port inlet.

If your vehicle begins charging and the charge port light pulses green, the charge cable may not have been fully inserted before. AC charging should no longer be limited, and DC Fast Charging / Supercharging should be available.

If charging is still limited or the vehicle will not charge at all, inspect the charge port inlet and the charge cable connector for any obstructions, such as debris, moisture, and/or foreign objects. Make sure any charge port inlet obstruction has been removed and any moisture has been allowed to dry, then try re-inserting the cable into the charge port.

If charging is still limited or the vehicle will not charge at all, make sure the charge port latch manual release cable (located on the left-hand side in the trunk) has not been pulled. Make sure the handle (usually ring-shaped or a strap) for the manual release cable is free of obstructions and that nothing is attached to it (like a cargo net or umbrella). For more information on using the charge port manual release, see [Manually Releasing Charge Cable on page 176](#).

You can also try charging your vehicle using a Tesla Supercharger or Destination Charging location, all of which can be located through the map on your vehicle's touchscreen display. See [Maps and Navigation on page 159](#) for more details.

For more information on troubleshooting Mobile Connector or Wall Connector status lights, refer to the product's Owner's Manual at [Charging & Adapter Product Guides](#).

For more information on charging, see [Charging Instructions on page 173](#).

CP_a055

Charging equipment communication lost

Check power source and charging equipment

What this alert means:

Charging stopped because communication between the vehicle and the external charging equipment was interrupted.

This alert is usually specific to external charging equipment and power sources and does not typically indicate an issue with your vehicle that can be resolved by scheduling service.

What to do:

Confirm whether the external charging equipment is powered by looking for any status lights, displays, or other indicators on the equipment. For more information on troubleshooting Mobile Connector or Wall Connector status lights, refer to the product's Owner's Manual at [Charging & Adapter Product Guides](#).



If the equipment is **not** powered, try to restore the external charging equipment's power source.

- If attempting to charge at a public station and power is unable to be restored, contact the station operator.
- If attempting to charge at a private station (for example: charging at home) and power is unable to be restored, contact an electrician.

If the equipment is powered, try charging the vehicle using different external charging equipment.

- If the vehicle begins charging, the issue was likely with the equipment.
- If the vehicle still does not charge, the issue may be with the vehicle.

You can also try charging your vehicle using a Tesla Supercharger or Destination Charging location, all of which can be located through the map on your vehicle's touchscreen display. See [Maps and Navigation on page 159](#) for more details.

CP_a056

Charging stopped - Charge cable disconnected **Close charge port - Press brake pedal and retry**

What this alert means:

Charging has stopped because your vehicle has detected that the connection between the charge port and charge cable has been unexpectedly interrupted.

What to do:

Before disconnecting a charge cable, make sure you first stop charging.

With some external charging equipment, charging may be stopped by pressing the button on the charge handle.

You can also stop charging from your vehicle touchscreen, your Tesla Mobile App, or the charging station.

For more information, see [Stopping Charging on page 175](#).

CP_a058

Unable to AC charge - Unplug and retry **Or try DC Fast Charging / Supercharging**

What this alert means:

Your vehicle is unable to AC charge because it has detected one of the following conditions and has tried to charge too many times without success:

- The charge port is unable to detect whether a charge cable is inserted or detect the type of charge cable connected.
- Your vehicle is unable to sense a valid pilot control signal coming from the charging station, so it cannot communicate effectively with the external charging equipment.
- Communication between your vehicle and the external charging equipment has been interrupted.
- The external charging equipment has reported an error that prevents your vehicle from charging.

When this alert is present, there will always be at least one other alert present that identifies a more specific condition.

What to do:

For more information and troubleshooting suggestions, check in your vehicle touchscreen under **Controls > Service > Notifications** for other recent alerts that involve charging.



CP_a066

Charging equipment not ready See equipment instructions to start charging

What this alert means:

Charging cannot begin because the charging station is communicating to your vehicle that either the external charging equipment is not ready or charging is not authorized. The control pilot signal that communicates between the charging station and your vehicle indicates that your vehicle is not allowed to start charging.

This could occur because:

- The charging station is actively delaying charging. For example, this can happen because the station has a scheduled charging feature activated.
- The charging station requires further activation before the charge session can begin. Some additional authentication may be needed before the station starts charging your vehicle, such as a charging card, a mobile app, or a credit card.

This alert is usually specific to external charging equipment and power sources and does not typically indicate an issue with your vehicle that can be resolved by scheduling service.

What to do:

Check the charging station for any instructions that explain the steps necessary to enable charging. For example, look for a touchscreen terminal, LED status indicators, printed instructions, or a payment interface that might provide guidance. If you cannot enable charging on the current charging station, try charging the vehicle with different charging equipment or at a different charging station.

- If the vehicle begins charging, the issue was likely with the equipment.
- If the vehicle still does not charge, the issue may be with the vehicle.

You can also try charging your vehicle using a Tesla Supercharger or Destination Charging location, all of which can be located through the map on your vehicle's touchscreen display. See [Maps and Navigation on page 159](#) for more details.

For more information on troubleshooting Mobile Connector or Wall Connector status lights, refer to the product's Owner's Manual at [Charging & Adapter Product Guides](#).

For more information on charging, see [Charging Instructions on page 173](#).

CP_a078

Cable blocked - Charge port latch may be frozen Try using Defrost Car button in Mobile App

What this alert means:

The charge port latch cannot unlatch the charge cable, and cold ambient temperature is detected.

What to do:

To remove any strain on the cable, re-insert the charge cable fully into the charge port inlet. Try again to unlatch the charge cable.

If the charge cable still cannot be removed, the charge port latch may be frozen.

To help thaw any ice on the charge port latch, press the **Defrost Car** button in your Tesla Mobile App to defrost your vehicle for approximately 30 to 45 minutes.

NOTE: Be sure to use **Defrost Car** in your Mobile App to defrost your vehicle. Adjusting the climate control settings in your vehicle's touchscreen is not as effective.



It may also be possible to thaw any ice affecting the charge port latch by turning on rear defrost via your vehicle touchscreen. Some vehicles are equipped with a charge port inlet heater that turns on when you turn on the rear defrost in cold weather conditions.

For more information on charging in cold weather conditions, see [Cold Weather Best Practices on page 155](#).

If the charge cable still cannot be removed, try the charge port manual release cable in your vehicle's trunk.

1. Make sure your vehicle is not actively charging.
 - On your vehicle touchscreen, access the charging screen.
 - If necessary, press Stop Charging.
2. Open the rear trunk.
3. Pull the charge port release cable downwards to unlatch the charge cable.
 - **NOTE:** The release cable is located on the left hand side of the rear trunk. It may be recessed within a small opening of the trunk interior trim.
4. Pull the charge cable from the charge port.

For more information on using the charge port manual release, see [Manually Releasing Charge Cable on page 176](#).

For more information on charging, see [Charging Instructions on page 173](#).

CP_a079

Charge rate reduced - Charge port may be frozen Try using Defrost Car button in Mobile App

What this alert means:

The charge port latch is unable to secure the charge cable in the charge port inlet, and cold ambient temperature is detected. If the latch is not engaged, AC charging (for example, charging with a Mobile Connector or Wall Connector) will be limited to 16A and DC Fast Charging / Supercharging will be unavailable.

The charge port light will pulse amber if this alert appears during AC charging and will be solid amber if this alert appears when attempting to DC Fast Charge / Supercharge.

This alert is usually specific to external charging equipment and power sources and does not typically indicate an issue with your vehicle that can be resolved by scheduling service.

What to do:

Try re-inserting the charge cable fully into the charge port inlet. If your vehicle begins charging and the charge port light pulses green, the charge cable may not have been fully inserted before. AC charging should no longer be limited, and DC Fast Charging / Supercharging should be available.

If charging is still limited or the vehicle will not charge at all, make sure the charge port latch manual release cable (located on the left-hand side in the trunk) has not been pulled. Make sure the handle (usually ring-shaped or a strap) for the manual release cable is free of obstructions and that nothing is attached to it (like a cargo net or umbrella). For more information on using the charge port manual release, see [Manually Releasing Charge Cable on page 176](#).

If charging is still limited or the vehicle will not charge at all, inspect the charge port inlet and the charge cable connector for any obstructions, such as debris, moisture, and/or foreign objects. Make sure any charge port inlet obstruction has been removed and any moisture has been allowed to dry, then try re-inserting the cable into the charge port.

If you have checked for and cleared any debris or foreign objects, but charging is still limited or your vehicle will not charge at all, the charge port latch may be frozen. To help thaw any ice on the charge port latch, press the **Defrost Car** button in your Tesla Mobile App to defrost your vehicle for approximately 30 to 45 minutes.

NOTE: Be sure to use **Defrost Car** in your Mobile App to defrost your vehicle. Adjusting the climate control settings in your vehicle's touchscreen is not as effective.



Troubleshooting Alerts

It may also be possible to thaw any ice affecting the charge port latch by turning on rear defrost via your vehicle touchscreen. Some vehicles are equipped with a charge port inlet heater that turns on when you turn on the rear defrost in cold weather conditions.

For more information on charging in cold weather conditions, see [Cold Weather Best Practices on page 155](#).

If the alert remains present, limited AC charging should still be available.

For more information on charging, see [Charging Instructions on page 173](#).

CP_a101

Charge rate reduced - Wall connection hot Outlet or Wall Connector wiring must be checked

What this alert means:

High temperature detected by Wall Connector alerts indicate the building connection to the Wall Connector is getting too warm, so charging has been slowed to protect the wiring and Wall Connector.

This is not typically an issue with your vehicle or your Wall Connector, but rather an issue with the building wiring. This may be caused by a loose building wiring connection to the Wall Connector and can be fixed quickly by an electrician.

What to do:

Contact an electrician to inspect the building wiring connection to the Wall Connector. They should make sure that all wires are properly connected and torqued according to the installation guide for the Wall Connector.

Wall Connector installation guides can be found [here](#).

CP_a102

Unable to charge - Wall connection too hot Outlet or Wall Connector wiring must be checked

What this alert means:

High temperature detected by Wall Connector alerts indicate the building connection to the Wall Connector is getting too warm, so charging has been slowed to protect the wiring and Wall Connector.

This is not typically an issue with your vehicle or your Wall Connector, but rather an issue with the building wiring. This may be caused by a loose building wiring connection to the Wall Connector and can be fixed quickly by an electrician.

What to do:

Contact an electrician to inspect the building wiring connection to the Wall Connector. They should make sure that all wires are properly connected and torqued according to the installation guide for the Wall Connector.

For more information, see the [installation guide](#) for your Wall Connector.

CP_a143

Charging adapter has electric arc flash hazard Use different charging equipment

What this alert means:

Charging is unavailable because your vehicle has detected an electric arc flash hazard in the third-party charging adapter used to connect a Combined Charging System (CCS) charge handle to your vehicle's charge port.

An electric arc flash can occur if you attempt to unplug **while actively charging with the third-party charging adapter**, and an electric arc flash can cause serious bodily injury and/or property damage.



What to do:

Follow the steps below to mitigate this risk:

- Make sure charging is completely stopped.
 1. Use your vehicle touchscreen to confirm charging has stopped, or to stop charging if necessary.
 2. Use the charging station display and controls to confirm charging has stopped, or to end any active charging session.
- Make sure no flashing green or blue light (LED) is visible on your vehicle's charge port.
- Unplug the charging adapter from your vehicle's charge port.
- Confirm again that the charging station indicates no active charging session.
- Unplug the charging adapter from the charge handle.

Use different charging equipment to charge your vehicle. For more information on charging, see [Charging Instructions on page 173](#).

You can also try charging your vehicle using a Tesla Supercharger or Destination Charging location, all of which can be located through the map on your vehicle's touchscreen display. See [Maps and Navigation on page 159](#) for more details.

CP_a151

Charge port error detected - Service is required AC charging may not function / OK to Supercharge

What this alert means:

Your vehicle's charge port requires service. The charge port is unable to establish a valid control pilot signal and communicate effectively with some AC charging equipment and power sources.

While this alert remains present, AC charging and DC Fast Charging with non-Tesla charging stations may be limited or unavailable.

What to do:

It is recommended that you schedule service to have your vehicle's charge port inspected at your earliest convenient opportunity.

In the meantime, Supercharging should continue to be available. Supercharging locations can be displayed through the map on your vehicle's touchscreen. See [Maps and Navigation on page 159](#) for more details.

AC charging may also be available using a Gen 2 Mobile Connector or Gen 3 Wall Connector. However, it is recommended that you make sure your vehicle's charge port can communicate with your Tesla charging product. Try charging with your Gen 2 Mobile Connector or Gen 3 Wall Connector, and confirm your vehicle is charging as expected, before relying on it.

For more information on troubleshooting Mobile Connector or Wall Connector status lights, refer to the product's Owner's Manual at [Charging & Adapter Product Guides](#).

For more information on charging, see [Charging Instructions on page 173](#).

CP_a164

Charge handle still detected after unlatch request Use charge port manual release cable if needed

What this alert means:

Your vehicle's charge port detects a charge cable / charge handle is still connected after receiving multiple requests to unlatch the charge cable so it can be disconnected.

This alert may indicate the charge port latch is not releasing the charge cable as expected.



Troubleshooting Alerts

What to do:

If the charge cable cannot be removed from the charge port after multiple attempts to unlatch it, try the manual release cable in your vehicle's trunk.

1. Make sure your vehicle is not actively charging.
 - On your vehicle touchscreen, access the charging screen.
 - If necessary, press Stop Charging.
2. Open the rear trunk.
3. Pull the charge port release cable downwards to unlatch the charge cable.
 - **NOTE:** The release cable is located on the left hand side of the rear trunk. It may be recessed within a small opening of the trunk interior trim.
4. Pull the charge cable from the charge port.

For more information on using the charge port manual release, see [Manually Releasing Charge Cable on page 176](#).

If the charge cable still cannot be removed, the charge port latch may be frozen.

To help thaw any ice on the charge port latch, press the **Defrost Car** button in your Tesla Mobile App to defrost your vehicle for approximately 30 to 45 minutes.

NOTE: Be sure to use **Defrost Car** in your Mobile App to defrost your vehicle. Adjusting the climate control settings in your vehicle's touchscreen is not as effective.

It may also be possible to thaw any ice affecting the charge port latch by turning on rear defrost via your vehicle touchscreen. Some vehicles are equipped with a charge port inlet heater that turns on when you turn on the rear defrost in cold weather conditions.

For more information on charging in cold weather conditions, see [Cold Weather Best Practices on page 155](#).

If this alert occurs repeatedly over multiple drives and charging attempts, it is recommended that you schedule service to have your vehicle's charge port inspected at your earliest convenient opportunity.

For more information on troubleshooting Mobile Connector or Wall Connector status lights, refer to the product's Owner's Manual at [Charging & Adapter Product Guides](#).

If using other external charging equipment, refer to the manufacturer's provided documentation for troubleshooting tips.

For more information on charging, see [Charging Instructions on page 173](#).

DI_a138

Front motor disabled - OK to drive Vehicle power may be limited

What this alert means:

Your vehicle's front motor is unavailable. Power, speed, and acceleration may be reduced as your vehicle uses the rear motor(s) to continue driving.

What to do:

Continue to your destination. Your vehicle is OK to drive.

This alert may be caused by a temporary condition that will be resolved automatically. If this alert clears during your current drive, or is no longer present when you start your next drive, it was likely caused by a temporary condition. No action is required.

This alert may also indicate a condition requiring front motor inspection and service. If this alert persists throughout subsequent drives, it is recommended that you schedule service. Your vehicle is OK to drive in the meantime.



DI_a166

Vehicle automatically parked to prevent rollaway Fasten seatbelt and close door to stay in gear

What this alert means:

Your vehicle has automatically shifted into Park (P) because it determined the driver was leaving or no longer present. This is expected vehicle behavior under various circumstances.

Your vehicle will automatically shift into Park if **all** of these conditions are true:

- Autopark is not active
- Your vehicle is traveling slower than 1.4 mph (2.25 km/h) in Drive or Reverse
- The last driver activity was detected more than 2 seconds ago. Driver activity includes:
 - Pressing the brake and/or accelerator pedal
 - Manually steering the vehicle

And at least **two** of these conditions are true:

1. Driver seatbelt is detected as unbuckled.
2. Driver is not detected as present.
3. Driver door is detected as open.

NOTE: Your vehicle will also automatically shift into Park when a charge cable is connected to the charge port.

What to do:

For more information on automatic shifting into Park, see [Shifting on page 79](#).

DI_a175

Cruise control unavailable

What this alert means:

Cruise Control, including Traffic-Aware Cruise Control, is currently unavailable.

Cruise Control might be unavailable because:

- The driver canceled the request.
- The driver unbuckled their seatbelt.
- The front trunk, trunk, or a door is open.
- The vehicle is traveling below the Cruise Control minimum speed of 18 mph (30 km/h).
- There is an environmental condition, such as limited visibility.
- Valet mode is active.

What to do:

Take control and drive your vehicle manually.

When any condition preventing Cruise Control activation is no longer present, Cruise Control should be available. If this alert persists throughout subsequent drives, schedule service at your earliest convenience. Your vehicle is OK to drive in the meantime.

For more information, see [Traffic-Aware Cruise Control on page 108](#).



DI_a184

Autopark canceled Take control

What this alert means:

Autopark has been canceled.

Autopark might have been canceled because:

- The driver pressed the Cancel button on the touchscreen.
- The driver used the gear stalk or moved the steering wheel.
- The driver pressed the accelerator pedal, pressed the brake pedal, or opened a door.
- There is a steep slope / grade.
- There is a weather condition affecting visibility.
- The curb cannot be detected.
- A trailer is attached to the vehicle.

What to do:

Park, or finish parking, your vehicle manually. Once you have finished parking, apply the brakes and shift into Park. Your vehicle will otherwise remain free-rolling.

Autopark should be available again during your next drive.

For more information, see [To Cancel Parking on page 124](#) and [Limitations and Warnings on page 129](#).

DI_a185

Autopark Aborted

What this alert means:

Autopark has aborted and the Electronic Parking Brake has been applied.

Autopark might have been canceled because:

- The driver pressed the Cancel button on the touchscreen.
- The driver used the gear stalk or moved the steering wheel.
- The driver pressed the accelerator pedal, pressed the brake pedal, or opened a door.
- There is a steep slope / grade.
- There is a weather condition affecting visibility.
- The curb cannot be detected.
- A trailer is attached to the vehicle.

What to do:

Park, or finish parking, your vehicle manually.

Autopark should be available again during your next drive.

For more information, see [To Cancel Parking on page 124](#) and [Limitations and Warnings on page 129](#).



DI_a190

Rear tire tread depth low - Schedule service Inspect tires for rotation/replacement

What this alert means:

NOTE: This alert does NOT indicate that there is a flat tire.

Your vehicle has detected that the rear tires have experienced more wear over time than the front tires, exceeding the recommended difference.

What to do:

It is recommended that the tread depth on all tires be inspected. As your tires wear during normal driving, the rear tires generally wear more quickly than the front tires.

Tire rotation is important to balance tire wear evenly across all tires. When staggered tires (different front and rear tire sizes) are installed, regularly rotating the front and rear tires between the left and right sides of your vehicle will still make your tires wear more evenly and extend their life.

Failure to rotate tires as recommended poses a risk of hydroplaning and losing control of the vehicle on wet roads. Failure to rotate tires also decreases the life of your tires, requiring premature replacement.

It is recommended that you schedule service via your Tesla Mobile App or with an independent service provider to have your tires rotated when:

- The difference in tire tread depth between any front and rear tire exceeds 1.5mm
- Your vehicle has been driven for more than 6,250 miles (10,000 km) since the last rotation

Tires may need to be replaced if the rear tread depth is determined to be at an unsafe level and either of these conditions applies:

- A tire rotation is no longer adequate
- Staggered tires (different front and rear tire sizes) installed on your vehicle make front/rear tire rotation unavailable

Upon completion of tire inspection and any necessary tire service, update your vehicle's tire configuration to optimize your vehicle settings to your tires and clear the alert for at least 6,250 miles. For more information, see [Tire Care and Maintenance on page 185](#).

It is not recommended that you rely on this alert instead of routine checks of tire tread depth. This alert should only be present when your vehicle estimates the tires are far beyond the recommended service interval.

This alert is calibrated for Tesla tires and is not expected to work with tires of different types or sizes, including combinations of different tire brands or models. It may not display, or may display prematurely, on vehicles using tires not recommended by Tesla. For more information on recommended tires, see [Wheels and Tires on page 214](#).

DI_a245

Vehicle Hold feature unavailable Keep brake pedal pressed while stopped

What this alert means:

Vehicle Hold is currently unavailable due to system constraints. When stopping, use the brake pedal to bring your vehicle to a complete stop and keep your vehicle stationary.

What to do:

Continue to your destination. Your vehicle is OK to drive.



Troubleshooting Alerts

If this alert persists throughout subsequent drives, schedule service at your earliest convenience. Your vehicle is OK to drive in the meantime.

For more information, see [Vehicle Hold](#) on page 91.

DIF_a251 / DIR_a251

Gearbox fluid service recommended Schedule Service

What this alert means:

Your vehicle has detected a condition requiring gearbox fluid inspection.

What to do:

It is recommended that you schedule service.

Your vehicle is OK to drive with this alert present. However, continuing to drive over an extended period of time with this alert present may result in permanent gearbox / powertrain damage.

EPBL_a195 / EPBR_a195

Vehicle automatically parked to prevent rollaway Fasten seatbelt and close door to stay in gear

What this alert means:

Your vehicle has automatically shifted into Park (P) because it determined the driver was leaving or no longer present. This is expected vehicle behavior under various circumstances.

Your vehicle will automatically shift into Park if **all** of these conditions are true:

- Autopark is not active
- Your vehicle is traveling slower than 1.4 mph (2.25 km/h) in Drive or Reverse
- The last driver activity was detected more than 2 seconds ago. Driver activity includes:
 - Pressing the brake and/or accelerator pedal
 - Manually steering the vehicle

And at least **two** of these conditions are true:

1. Driver seatbelt is detected as unbuckled.
2. Driver is not detected as present.
3. Driver door is detected as open.

NOTE: Your vehicle will also automatically shift into Park when a charge cable is connected to the charge port.

What to do:

For more information on automatic shifting into Park, see [Shifting](#) on page 79.

ESP_a118

Assist for low brake performance activated To stop, keep brake pedal firmly pressed

What this alert means:



Hydraulic Fade Compensation is active. This brake assist function activates temporarily to make sure you have full braking capability in conditions where reduced braking performance is detected by your vehicle.

When this assist function activates, you may feel the brake pedal pull away from your foot and notice a strong increase in brake pressure. You may also hear a pumping sound coming from the brake hydraulic unit at the front of the vehicle. This will usually last for a few seconds, depending on road surface and vehicle speed. This is completely normal and does not indicate any issue with your vehicle.

What to do:

Continue to press the brake pedal as you normally would, and do not "pump" (repeatedly press and release) the pedal as this will interrupt the function.

This alert will clear when your vehicle comes to a stop or you are no longer pressing the brake pedal. It may still be displayed for up to 5 seconds afterward.

Reduced braking performance is usually temporary, and can occur for a number of reasons including high brake temperatures after heavy brake use, or driving in extremely cold or wet conditions. It can also indicate that your brake pads or rotors have worn to the point that normal replacement is needed.

If you continue to experience reduced braking performance which does not improve over time, please contact Tesla service at your convenience for a brake inspection.

For more information, see [Hydraulic Fade Compensation on page 85](#).

PCS_a016

Cannot charge - Poor grid power quality possible Retry / Try other charge location or Supercharging

What this alert means:

Charging has stopped due to a condition that prevents your vehicle from charging with AC power. DC fast charging / Supercharging should still function as expected.

This may be due to power supply disturbances caused by the external charging equipment or by the electrical power grid. In some cases, this condition may be the result of using nearby electric devices that draw a lot of power.

If these possible causes can be ruled out, then a condition with your vehicle itself may also be affecting AC charging.

What to do:

If this alert is accompanied by another alert that specifies the condition affecting AC charging, start by investigating that alert.

Further troubleshooting tips based on equipment type:

- If using a Mobile Connector, try charging the vehicle with a different wall outlet.
 - If the vehicle starts to charge, the issue was likely with the original wall outlet.
 - If the vehicle still does not charge, the issue may be with the Mobile Connector.
- If using a Wall Connector, try charging the vehicle with different charging equipment like a Mobile Connector powered by a separate wall outlet.
 - If the vehicle starts to charge, the issue was likely with the Wall Connector.

If the issue is with the original wall outlet or the Wall Connector, contact an electrician to inspect the wiring connection.

You can also try charging your vehicle using a Tesla Supercharger or Destination Charging location, all of which can be located through the map on your vehicle's touchscreen display. See [Maps and Navigation on page 159](#) for more details.

If this alert persists when attempting to charge at multiple locations and with different charging equipment, it is recommended that you schedule service.



Troubleshooting Alerts

For more information on troubleshooting Mobile Connector or Wall Connector status lights, refer to the product's Owner's Manual at [Charging & Adapter Product Guides](#).

PCS_a017

Charging stopped - Power lost while charging

Check power source and charging equipment

What this alert means:

Power has been lost during charging. This could result from the charging equipment losing power from the source (for example, a wall outlet) or from an issue with the charging equipment.

What to do:

This alert is often accompanied by other alerts that can help you identify and troubleshoot the issue. Start by investigating any other displayed alerts that relate to charging issues.

Alternatively, you can check Mobile Connector or Wall Connector status lights to confirm power to the device, and also refer to the product owner's manual for troubleshooting information based on blink codes. If using other (non-Tesla) external charging equipment, check for a display or other user interface that provides troubleshooting help.

If there is clearly no power to the charging equipment, check the circuit breaker for the wall outlet / Wall Connector to make sure it has not tripped.

Further troubleshooting tips based on equipment type:

- If using a Mobile Connector, try charging the vehicle with a different wall outlet.
 - If the vehicle starts to charge, the issue was likely with the original wall outlet.
 - If the vehicle still does not charge, the issue may be with the Mobile Connector.
- If using a Wall Connector, try charging the vehicle with different charging equipment like a Mobile Connector powered by a separate wall outlet.
 - If the vehicle starts to charge, the issue was likely with the Wall Connector.

If the issue is with the original wall outlet or the Wall Connector, contact an electrician to inspect the wiring connection.

This alert is usually specific to external charging equipment and power sources and does not typically indicate an issue with your vehicle that can be resolved by scheduling service.

You can also try charging your vehicle using a Tesla Supercharger or Destination Charging location, all of which can be located through the map on your vehicle's touchscreen display. See [Maps and Navigation on page 159](#) for more details.

For more information on troubleshooting Mobile Connector or Wall Connector status lights, refer to the product's Owner's Manual at [Charging & Adapter Product Guides](#).

PCS_a019

Power grid or vehicle issue limiting AC charging

Unplug and retry / Try different charging location

What this alert means:

Charging speed has been reduced due to a condition that affects your vehicle's ability to charge with AC power. DC fast charging / Supercharging should still function as expected.

This may be due to power supply disturbances caused by the external charging equipment or by the electrical power grid. In some cases, this condition may be the result of using nearby electric devices that draw a lot of power.

If these possible causes can be ruled out, then a condition with your vehicle itself may also be affecting AC charging.

What to do:



If this alert is accompanied by another alert that specifies the condition affecting AC charging, start by investigating that alert.

Further troubleshooting tips based on equipment type:

- If using a Mobile Connector, try charging the vehicle with a different wall outlet.
 - If the vehicle starts to charge, the issue was likely with the original wall outlet.
 - If the vehicle still does not charge, the issue may be with the Mobile Connector.
- If using a Wall Connector, try charging the vehicle with different charging equipment like a Mobile Connector powered by a separate wall outlet.
 - If the vehicle starts to charge, the issue was likely with the Wall Connector.

If the issue is with the original wall outlet or the Wall Connector, contact an electrician to inspect the wiring connection.

You can also try charging your vehicle using a Tesla Supercharger or Destination Charging location, all of which can be located through the map on your vehicle's touchscreen display. See [Maps and Navigation on page 159](#) for more details.

If this alert persists when attempting to charge at multiple locations and with different charging equipment, it is recommended that you schedule service.

For more information on troubleshooting Mobile Connector or Wall Connector status lights, refer to the product's Owner's Manual at [Charging & Adapter Product Guides](#).

PCS_a032

Poor electric grid power quality detected Try different charging station or location

What this alert means:

Charging speed has been reduced or charging has been interrupted due to a condition that affects your vehicle's ability to charge with AC power. DC fast charging / Supercharging should still function as expected.

The onboard charger in your vehicle has detected power supply disturbances in the electrical power grid. These disturbances interfere with your vehicle's charging process.

Typical causes of these power supply disturbances include:

- Issues with the building wiring and/or the wall outlet.
- Issues with the external charging equipment.
- Other large electric devices, such as washing machines or air conditioning units, that temporarily draw a lot of power or otherwise disturb the electrical power grid.
- External conditions affecting the electrical power grid.

What to do:

As this alert is usually specific to external charging equipment and power sources, and it does not typically indicate an issue with your vehicle that can be resolved by scheduling service, it is recommended that you:

- Try charging with different wall outlets.
- Try charging again (disconnect and reconnect to retry) when other large electric devices are not drawing power.
- Try charging with multiple, different types of charging equipment at different locations.

You can also try charging your vehicle using a Tesla Supercharger or Destination Charging location, all of which can be located through the map on your vehicle's touchscreen display. See [Maps and Navigation on page 159](#) for more details.

For more information on troubleshooting Mobile Connector or Wall Connector status lights, refer to the product's Owner's Manual at [Charging & Adapter Product Guides](#).



PCS_a052

External charging equipment not providing power Check power source or try different equipment

What this alert means:

Charging cannot begin due to a condition that prevents your vehicle from charging with AC power. DC fast charging / Supercharging should still function as expected.

Your vehicle has requested AC power from the external charging equipment, but the onboard charger does not detect any supply voltage coming from the equipment.

This can sometimes be caused by a hardware issue specific to the external charging equipment, which prevents the charging equipment from switching power to the vehicle on or off when requested. It could also occur due to another condition affecting the external charging equipment, the power source it is connected to, or your vehicle itself.

What to do:

This alert is usually specific to external charging equipment and power sources and does not typically indicate an issue with your vehicle that can be resolved by scheduling service.

Try charging with multiple, different types of charging equipment.

You can also try charging your vehicle using a Tesla Supercharger or Destination Charging location, all of which can be located through the map on your vehicle's touchscreen display. See [Maps and Navigation on page 159](#) for more details.

For more information on troubleshooting Mobile Connector or Wall Connector status lights, refer to the product's Owner's Manual at [Charging & Adapter Product Guides](#).

PCS_a053

Charge rate reduced - Unexpected voltage drop Remove extension cords / Have wiring inspected

What this alert means:

Charging speed has been reduced because the onboard charger in your vehicle has detected a large voltage drop during charging.

Likely causes of this issue include:

- Problems with the building wiring and/or the wall outlet.
- An extension cord or other wiring that cannot support the requested charge current.

This issue can also result from turning on electric devices that draw a lot of power from the same branch circuit while the vehicle is charging.

What to do:

If this issue has occurred multiple times at your normal charging location, contact an electrician to inspect the electrical installation. They should check the following:

- Any installed charging equipment and its connection to the building wiring.
- The building wiring, including any wall outlet used with a Mobile Connector.
- The electrical connection to the power utility line where it enters the building.

Discuss with the electrician whether the charge current on the vehicle should be lowered, or if the installation should be upgraded to support a higher charge current.



This alert is usually specific to external charging equipment and power sources and does not typically indicate an issue with your vehicle that can be resolved by scheduling service.

You can also try charging your vehicle using a Tesla Supercharger or Destination Charging location, all of which can be located through the map on your vehicle's touchscreen display. See [Maps and Navigation on page 159](#) for more details.

For more information on troubleshooting Mobile Connector or Wall Connector status lights, refer to the product's Owner's Manual at [Charging & Adapter Product Guides](#).

PCS_a054

Charging stopped due to large voltage drop Remove extension cords / Have wiring inspected

What this alert means:

Charging has been interrupted because the onboard charger in your vehicle has detected an unusually large voltage drop.

Likely causes of this issue include:

- Problems with the building wiring and/or the wall outlet.
- An extension cord or other wiring that cannot support the requested charge current.

This issue can also result from turning on electric devices that draw a lot of power from the same branch circuit while the vehicle is charging.

What to do:

If this issue has occurred multiple times at your normal charging location, contact an electrician to inspect the electrical installation. They should check the following:

- Any installed charging equipment and its connection to the building wiring.
- The building wiring, including any wall outlet used with a Mobile Connector.
- The electrical connection to the power utility line where it enters the building.

Discuss with the electrician whether the charge current on the vehicle should be lowered, or if the installation should be upgraded to support a higher charge current.

This alert is usually specific to external charging equipment and power sources and does not typically indicate an issue with your vehicle that can be resolved by scheduling service.

You can also try charging your vehicle using a Tesla Supercharger or Destination Charging location, all of which can be located through the map on your vehicle's touchscreen display. See [Maps and Navigation on page 159](#) for more details.

For more information on troubleshooting Mobile Connector or Wall Connector status lights, refer to the product's Owner's Manual at [Charging & Adapter Product Guides](#).

PCS_a073

External charging equipment error detected Try different charging equipment

What this alert means:

AC charging cannot begin due to a condition that prevents your vehicle from charging with AC power. DC fast charging / Supercharging should still function as expected.

Your vehicle's onboard charger is detecting input voltage at the charge port when no power has been requested from the external charging equipment, which indicates the external charging equipment is not functioning as expected.



Troubleshooting Alerts

This can sometimes be caused by a hardware issue specific to the external charging equipment, which prevents the charging equipment from switching power to the vehicle on or off when requested. It could also occur due to another condition affecting the external charging equipment, or a condition affecting your vehicle itself.

What to do:

This alert is usually specific to external charging equipment and power sources and does not typically indicate an issue with your vehicle that can be resolved by scheduling service.

Try charging with multiple, different types of charging equipment.

You can also try charging your vehicle using a Tesla Supercharger or Destination Charging location, all of which can be located through the map on your vehicle's touchscreen display. See [Maps and Navigation on page 159](#) for more details.

For more information on troubleshooting Mobile Connector or Wall Connector status lights, refer to the product's Owner's Manual at [Charging & Adapter Product Guides](#).

PCS_a090

Charging slowed - Some AC phases not powered

Check power source and charging equipment

What this alert means:

Charging speed has been reduced due to a condition that affects your vehicle's ability to charge with AC power. DC fast charging / Supercharging should still function as expected.

Your vehicle's onboard charger has detected that one or more power converters is not receiving the necessary AC input voltage. For example: during three-phase charging, one phase might be missing from the AC input power provided by the external source. This could occur due to a condition affecting the external charging equipment, the power source it is connected to, or your vehicle itself.

What to do:

This alert is usually specific to external charging equipment and power sources and does not typically indicate an issue with your vehicle that can be resolved by scheduling service.

Try charging with multiple, different types of charging equipment.

You can also try charging your vehicle using a Tesla Supercharger or Destination Charging location, all of which can be located through the map on your vehicle's touchscreen display. See [Maps and Navigation on page 159](#) for more details.

For more information on troubleshooting Mobile Connector or Wall Connector status lights, refer to the product's Owner's Manual at [Charging & Adapter Product Guides](#).

PM_a092 / PMF_a092 / PMR_a092

Powertrain issue detected - Schedule service

Issue may persist even if functionality is restored

What this alert means:

Your vehicle's powertrain requires service. Power, speed, and acceleration may be reduced, and your vehicle may need to shut down while driving.

This alert indicates a persistent condition requiring powertrain inspection and service.

Even if this alert clears after the current drive and does not return during subsequent drives, service is required to resolve the powertrain issue your vehicle has detected.

What to do:

It is recommended that you schedule service for your vehicle's powertrain at your earliest opportunity.



Without service, your vehicle may continue to have reduced power, speed, and acceleration, may experience conditions that require it to shut down while driving, or may become unable to drive.

UI_a004

Front trunk open

Proceed with caution

What this alert means:

Your vehicle's front trunk (hood) is detected open while driving.

This alert indicates at least one of the two latches securing the hood, the front trunk primary and/or secondary latch, cannot be confirmed closed (confirmed as fully secured) when your vehicle is shifted into a gear other than Park.

What to do:

As this condition may lead to the front trunk opening while driving, it is recommended that you drive carefully until you can safely bring your vehicle to a stop and shift into Park.

Once your vehicle is parked, check the front trunk (hood) to make sure it is fully closed (both latches are fully engaged). For more information, see Closing instructions for the [Front Trunk on page 27](#).

The alert should clear once your vehicle is shifted into Park. However, it may return once you start driving if you do not first inspect and fully secure the hood.

If this alert persists across multiple drives, or occurs with increasing frequency over several drives, it is recommended that you schedule service at your earliest convenience.

For more information on the front trunk, see [Front Trunk on page 27](#).

UI_a006

Service is required

Schedule service now

What this alert means:

This alert is set remotely by Tesla when a condition requiring service is detected on your vehicle.

This alert can be set due to various conditions. When you schedule service, more information should be available.

This alert can only be cleared by a service technician after your vehicle has been serviced.

What to do:

As this alert can be present due to various conditions, it is recommended that you schedule service at your earliest convenience.

UI_a137

Active service connection to vehicle

Service performing remote diagnostics

What this alert means:

A service technician is remotely logged into your vehicle for diagnosis or repair. You may notice some loss of Infotainment functionality while the connection persists, but this alert does not indicate an issue with your vehicle.

Your vehicle is OK to drive.

What to do:



Troubleshooting Alerts

This alert should clear automatically after the technician completes vehicle diagnosis or repair. You may find it necessary to restart your touchscreen to restore full Infotainment functionality after the alert has cleared. For more information, see [Restarting the Touchscreen](#) in your vehicle's [Do It Yourself Guide](#).

If this alert does not clear after 24 hours, it is recommended that you schedule service via your Tesla Mobile App or with an independent service provider. Please note that independent service provider options may vary, based on your vehicle configuration and your location.

UMC_a001

Unable to charge with Mobile Connector Inadequate outlet grounding – Try another outlet

What this alert means:

The Mobile Connector has detected that the electrical outlet has insufficient grounding, likely caused by an inadequate or missing ground connection.

This does not indicate an issue with your Mobile Connector or vehicle, but instead points to an issue with the wall outlet / electrical installation the Mobile Connector is connected to.

What to do:

Have the electrical installation inspected by an electrician. Your electrician should make sure there is proper grounding at your circuit breaker or power distribution box, and also make sure that appropriate connections are made to the outlet, before you attempt to plug in the Mobile Connector again.

If you need to charge in the meantime, try charging using a different outlet, at another location, or with another type of charging station.

You can also try charging your vehicle using a Tesla Supercharger or Destination Charging location, all of which can be located through the map on your vehicle's touchscreen display. See [Maps and Navigation](#) on page 159 for more details.

For more information on troubleshooting Mobile Connector status lights and charging issues, refer to the [product's owner's manual](#).

UMC_a002

Unable to charge – Mobile Connector GFCI tripped Unplug charge handle from charge port and retry

What this alert means:

The vehicle cannot charge because the ground-fault circuit interrupter (GFCI) in the Mobile Connector has tripped.

Like the GFCI in a wall outlet, this feature is designed to stop the flow of electricity when there is a problem. It has interrupted charging to protect your vehicle and the charging equipment.

This could happen for many reasons. The problem could be in the charge cable, the charge handle, the charge port, or even an onboard vehicle component.

What to do:

Inspect the charge port and the charge handle for pooled water or unusual levels of moisture. If you find excessive moisture, wait and let both the inside area of the charge port and the exposed portion of the charge handle dry sufficiently before trying again.

Inspect the charge equipment for damage.

- If the cable is in any way damaged or deteriorated, **do not use it**. Try different charging equipment instead.
- If the cable is in good condition, try charging again with the same Mobile Connector.

If the issue persists and prevents charging, try charging with different charging equipment.



This alert is usually specific to external charging equipment and power sources and does not typically indicate an issue with your vehicle that can be resolved by scheduling service.

You can also try charging your vehicle using a Tesla Supercharger or Destination Charging location, all of which can be located through the map on your vehicle's touchscreen display. See [Maps and Navigation on page 159](#) for more details.

For more information on troubleshooting Mobile Connector status lights and charging issues, refer to the [product's owner's manual](#).

UMC_a004

Unable to charge with Mobile Connector Voltage too high / Try a different wall outlet

What this alert means:

The vehicle cannot charge, or charging is interrupted, because **either** the Mobile Connector:

- Detects the wall outlet voltage is too high, **or**
- Detects an unexpected increase in supply voltage from the wall outlet.

What to do:

Try charging the vehicle with a different wall outlet. If the vehicle starts to charge, the issue was likely with the original wall outlet. Contact an electrician to inspect the building wiring connection to that outlet.

If the vehicle still does not charge when you try a different wall outlet, try charging at a different location.

You can also try charging your vehicle using a Tesla Supercharger or Destination Charging location, all of which can be located through the map on your vehicle's touchscreen display. See [Maps and Navigation on page 159](#) for more details.

For more information on troubleshooting Mobile Connector status lights and charging issues, refer to the [product's owner's manual](#).

UMC_a005

Unable to charge with Mobile Connector Voltage too low / Try a different wall outlet

What this alert means:

The vehicle cannot charge, or charging is interrupted, because **either** the Mobile Connector:

- Does not detect enough supply voltage from the wall outlet, **or**
- Detects an unexpected drop in supply voltage from the wall outlet.

What to do:

Try charging the vehicle with a different wall outlet. If the vehicle starts to charge, the issue was likely with the original wall outlet. Contact an electrician to inspect the building wiring connection to that outlet.

If the vehicle still does not charge when you try a different wall outlet, try charging at a different location.

This alert is usually specific to external charging equipment and power sources and does not typically indicate an issue with your vehicle that can be resolved by scheduling service.

You can also try charging your vehicle using a Tesla Supercharger or Destination Charging location, all of which can be located through the map on your vehicle's touchscreen display. See [Maps and Navigation on page 159](#) for more details.

For more information on troubleshooting Mobile Connector status lights and charging issues, refer to the [product's owner's manual](#).



UMC_a007

Mobile Connector control box temperature high Let Mobile Connector cool to resume charging

What this alert means:

Charging has been interrupted because the Mobile Connector has detected a high temperature inside its control box housing.

What to do:

Make sure the Mobile Connector is not covered by anything, and that there is no heat source nearby. If the problem persists in normal ambient temperatures (under 38°C), service is required.

You can also try charging your vehicle using a Tesla Supercharger or Destination Charging location, all of which can be located through the map on your vehicle's touchscreen display. See [Maps and Navigation on page 159](#) for more details.

For more information on troubleshooting Mobile Connector status lights and charging issues, refer to the [product's owner's manual](#).

UMC_a008

Unable to charge - Wall plug temperature high Wall outlet and wiring inspection recommended

What this alert means:

High temperature detected by Mobile Connector alerts indicate the outlet used to charge is becoming too warm, so charging has stopped to protect the outlet.

This does not indicate an issue with your Mobile Connector or vehicle, but instead points to an issue with the wall outlet / electrical installation the Mobile Connector is connected to.

A warm outlet may be caused by a plug that is not fully inserted, a loose building wiring connection to the outlet, or an outlet that is beginning to wear out.

What to do:

Make sure your adapter is fully plugged into the outlet. If charging speed does not return to normal, contact an electrician to inspect the outlet and building wiring connections to the outlet and complete any repairs needed.

If the outlet is worn, it should be replaced with a high-quality outlet. Consider upgrading to a Tesla Wall Connector for greater convenience and highest charging speed.

UMC_a009

Cannot charge - Charge handle temperature high Check charge handle or charge port for debris

What this alert means:

Charging has been interrupted because the Mobile Connector has detected a high temperature in the charge handle that connects to your vehicle's charge port.

What to do:

Make sure the Mobile Connector is fully inserted into your vehicle's charge port inlet.

Inspect the charge port inlet and the Mobile Connector handle for any obstructions or moisture. Make sure any obstruction in the charge port or Mobile Connector handle has been removed and any moisture has been allowed to dry, then try re-inserting the Mobile Connector handle into the charge port.

Also make sure the charge handle of the Mobile Connector is not covered by anything, and that there is no heat source nearby.



If the alert persists in normal ambient temperatures (under 38°C), and occurs during multiple charging attempts, this may indicate a condition affecting the Mobile Connector or your vehicle. It is recommended that you schedule service at your convenience.

You can also try charging your vehicle using a Tesla Supercharger or Destination Charging location, all of which can be located through the map on your vehicle's touchscreen display. See [Maps and Navigation on page 159](#) for more details.

For more information on troubleshooting Mobile Connector status lights and charging issues, refer to the [product's owner's manual](#).

UMC_a010

Mobile Connector to adapter connection hot

Let cool - Plug adapter fully into Mobile Connector

What this alert means:

Charging has been interrupted because the Mobile Connector has detected a high temperature at the connection between the wall plug adapter and the control box.

What to do:

Make sure the wall plug adapter is fully connected to the Mobile Connector control box.

Also make sure the wall plug adapter is not covered by anything, and that there is no heat source nearby.

After unplugging from the power source (wall outlet), inspect the wall plug adapter connection and the Mobile Connector control box connection for any obstructions or moisture. Make sure any obstruction has been removed and any moisture has been allowed to dry, then try re-inserting the wall plug adapter into the Mobile Connector and then connecting to the power source (wall outlet).

Once the Mobile Connector control box temperature has decreased and any obstruction has been removed, the alert should clear and charging should be possible.

You can also try charging your vehicle using a Tesla Supercharger or Destination Charging location, all of which can be located through the map on your vehicle's touchscreen display. See [Maps and Navigation on page 159](#) for more details.

For more information on troubleshooting Mobile Connector status lights and charging issues, refer to the [product's owner's manual](#).

UMC_a011

Charging equipment communication error

Try again or try different equipment

What this alert means:

Your vehicle is unable to charge because it cannot communicate effectively with the Mobile Connector. The Mobile Connector cannot confirm via proximity detection that the charge handle is fully connected to your vehicle.

What to do:

First, confirm the lack of effective communication is caused by the Mobile Connector rather than an issue with your vehicle. This is usually the case.

To confirm this, try charging the vehicle using different external charging equipment.

- If the vehicle begins charging, the issue was likely with the Mobile Connector.
- If the vehicle still does not charge, the issue may be with the vehicle.

Inspect the charge port inlet and the Mobile Connector handle for any obstructions (use a flashlight as necessary). Make sure any obstruction has been removed and any moisture has been allowed to dry, then try re-inserting the Mobile Connector handle into the charge port.



Troubleshooting Alerts

This alert is usually specific to external charging equipment and power sources and does not typically indicate an issue with your vehicle that can be resolved by scheduling service.

You can also try charging your vehicle using a Tesla Supercharger or Destination Charging location, all of which can be located through the map on your vehicle's touchscreen display. See [Maps and Navigation on page 159](#) for more details.

For more information on troubleshooting Mobile Connector status lights and charging issues, refer to the [product's owner's manual](#).

For more information on charging, see [Charging Instructions on page 173](#).

UMC_a012

Charging equipment communication error Try again or try different equipment

What this alert means:

Your vehicle is unable to charge because it cannot communicate effectively with the Mobile Connector. The Mobile Connector detects that it cannot generate or maintain a valid control pilot signal.

What to do:

First, confirm the lack of effective communication is caused by the Mobile Connector rather than an issue with your vehicle. This is usually the case.

To confirm this, try charging the vehicle using different external charging equipment.

- If the vehicle begins charging, the issue was likely with the Mobile Connector.
- If the vehicle still does not charge, the issue may be with the vehicle.

Inspect the charge port inlet and the Mobile Connector handle for any obstructions (use a flashlight as necessary). Make sure any obstruction has been removed and any moisture has been allowed to dry, then try re-inserting the Mobile Connector handle into the charge port.

This alert is usually specific to external charging equipment and power sources and does not typically indicate an issue with your vehicle that can be resolved by scheduling service.

You can also try charging your vehicle using a Tesla Supercharger or Destination Charging location, all of which can be located through the map on your vehicle's touchscreen display. See [Maps and Navigation on page 159](#) for more details.

For more information on troubleshooting Mobile Connector status lights and charging issues, refer to the [product's owner's manual](#).

For more information on charging, see [Charging Instructions on page 173](#).

UMC_a013

Wall plug adapter error - Charge rate reduced Plug adapter fully into Mobile Connector and retry

What this alert means:

Your Mobile Connector is unable to communicate with the wall plug adapter. Because your Mobile Connector cannot monitor the wall plug adapter temperature, charge current is automatically reduced to 8A.

What to do:

1. Unplug your Mobile Connector, including the wall plug adapter, completely from the wall outlet.
2. Make sure the connection between the wall plug adapter and the main body of your Mobile Connector is secure.
 - a. Disconnect the wall plug adapter completely from the main body of your Mobile Connector.



- b. Fully reinsert the wall plug adapter into the main body of your Mobile Connector by pushing it into the socket until it snaps into place.
3. Try charging again by plugging the Mobile Connector, including wall plug adapter, fully into the wall outlet.
4. If the alert persists, try using a different wall plug adapter (see steps above to make sure the adapter is fully connected to your Mobile Connector).
 - a. If the alert is no longer present, the issue is likely with the wall plug adapter you were using previously.
 - b. If the alert persists, the issue is likely with your Mobile Connector.

If needed, obtain another wall plug adapter or Mobile Connector.

In the meantime, you can continue to charge with the same equipment. The charge rate will be reduced, as charge current will be limited to 8A while this condition persists.

You can also try charging your vehicle using a Tesla Supercharger or Destination Charging location, all of which can be located through the map on your vehicle's touchscreen display. See [Maps and Navigation on page 159](#) for more details.

For more information on troubleshooting Mobile Connector status lights and charging issues, refer to the [product's owner's manual](#).

UMC_a014

Wall plug adapter error - Charge rate reduced Plug adapter fully into Mobile Connector and retry

What this alert means:

Your Mobile Connector is unable to communicate with the wall plug adapter. Because your Mobile Connector cannot identify the type of wall outlet the wall plug adapter is connected to, charge current is automatically reduced to 8A.

What to do:

1. Unplug your Mobile Connector, including the wall plug adapter, completely from the wall outlet.
2. Make sure the connection between the wall plug adapter and the main body of your Mobile Connector is secure.
 - a. Disconnect the wall plug adapter completely from the main body of your Mobile Connector.
 - b. Fully reinsert the wall plug adapter into the main body of your Mobile Connector by pushing it into the socket until it snaps into place.
3. Try charging again by plugging the Mobile Connector, including wall plug adapter, fully into the wall outlet.
4. If the alert persists, try using a different wall plug adapter (see steps above to make sure the adapter is fully connected to your Mobile Connector).
 - a. If the alert is no longer present, the issue is likely with the wall plug adapter you were using previously.
 - b. If the alert persists, the issue is likely with your Mobile Connector.

If needed, obtain another wall plug adapter or Mobile Connector. In the meantime, you can continue to charge with the same equipment. The charge rate will be reduced, as charge current will be limited to 8A while this condition persists.

You can also try charging your vehicle using a Tesla Supercharger or Destination Charging location, all of which can be located through the map on your vehicle's touchscreen display. See [Maps and Navigation on page 159](#) for more details.

For more information on troubleshooting Mobile Connector status lights and charging issues, refer to the [product's owner's manual](#).

UMC_a015

Wall plug adapter error - Charge rate reduced Plug adapter fully into Mobile Connector and retry

What this alert means:



Troubleshooting Alerts

Your Mobile Connector is unable to communicate with the wall plug adapter. Because your Mobile Connector cannot identify the type of wall outlet the wall plug adapter is connected to, charge current is automatically reduced to 8A.

What to do:

1. Unplug your Mobile Connector, including the wall plug adapter, completely from the wall outlet.
2. Make sure the connection between the wall plug adapter and the main body of your Mobile Connector is secure.
 - a. Disconnect the wall plug adapter completely from the main body of your Mobile Connector.
 - b. Fully reinsert the wall plug adapter into the main body of your Mobile Connector by pushing it into the socket until it snaps into place.
3. Try charging again by plugging the Mobile Connector, including wall plug adapter, fully into the wall outlet.
4. If the alert persists, try using a different wall plug adapter (see steps above to make sure the adapter is fully connected to your Mobile Connector).
 - a. If the alert is no longer present, the issue is likely with the wall plug adapter you were using previously.
 - b. If the alert persists, the issue is likely with your Mobile Connector.

If needed, obtain another wall plug adapter or Mobile Connector. In the meantime, you can continue to charge with the same equipment. The charge rate will be reduced, as charge current will be limited to 8A while this condition persists.

You can also try charging your vehicle using a Tesla Supercharger or Destination Charging location, all of which can be located through the map on your vehicle's touchscreen display. See [Maps and Navigation on page 159](#) for more details.

For more information on troubleshooting Mobile Connector status lights and charging issues, refer to the [product's owner's manual](#).

UMC_a016

Mobile Connector control box temperature high Maximum charge rate reduced

What this alert means:

Charge current has been temporarily reduced because the Mobile Connector has detected increased temperature inside its control box housing.

What to do:

Make sure the Mobile Connector is not covered by anything, and that there is no heat source nearby. If the problem persists in normal ambient temperatures (under 38°C), service is required.

You can also try charging your vehicle using a Tesla Supercharger or Destination Charging location, all of which can be located through the map on your vehicle's touchscreen display. See [Maps and Navigation on page 159](#) for more details.

For more information on troubleshooting Mobile Connector status lights and charging issues, refer to the [product's owner's manual](#).

UMC_a017

Charge rate reduced - Wall plug temperature high Wall outlet and wiring inspection recommended

What this alert means:

High temperature detected by Mobile Connector alerts indicate the outlet used to charge is becoming too warm, so charging has been slowed to protect the outlet.

This is not typically an issue with your vehicle or your Mobile Connector, but rather an issue with the outlet. A warm outlet may be caused by a plug that is not fully inserted, a loose building wiring connection to the outlet, or an outlet that is beginning to wear out.

**What to do:**

Make sure your adapter is fully plugged into the outlet. If charging speed does not return to normal, contact an electrician to inspect the outlet and building wiring connections to the outlet and complete any repairs needed.

If the outlet is worn, it should be replaced with a high-quality outlet. Consider upgrading to a Tesla Wall Connector for greater convenience and highest charging speed.

UMC_a018**Charge rate reduced - Handle temperature high
Check charge handle or charge port for debris****What this alert means:**

Charge current has been temporarily reduced because the Mobile Connector has detected increased temperature in the charge handle that connects to your vehicle's charge port.

What to do:

Make sure the Mobile Connector is fully inserted into your vehicle's charge port inlet.

Inspect the charge port inlet and the Mobile Connector handle for any obstructions or moisture. Make sure any obstruction in the charge port or Mobile Connector handle has been removed and any moisture has been allowed to dry, then try re-inserting the Mobile Connector handle into the charge port.

Also make sure the charge handle of the Mobile Connector is not covered by anything, and that there is no heat source nearby.

If the alert persists in normal ambient temperatures (under 38°C), and occurs during multiple charging attempts, this may indicate a condition affecting the Mobile Connector or your vehicle. It is recommended that you schedule service at your convenience.

You can also try charging your vehicle using a Tesla Supercharger or Destination Charging location, all of which can be located through the map on your vehicle's touchscreen display. See [Maps and Navigation on page 159](#) for more details.

For more information on troubleshooting Mobile Connector status lights and charging issues, refer to the [product's owner's manual](#).

UMC_a019**Mobile Connector to adapter connection hot
Maximum charge rate reduced****What this alert means:**

Charge current has been reduced because the Mobile Connector has detected a high temperature at the connection between the wall plug adapter and the control box.

What to do:

Make sure the wall plug adapter is fully connected to the Mobile Connector control box.

After unplugging from the power source (wall outlet), inspect the wall plug adapter connection and the Mobile Connector control box connection for any obstructions or moisture.

It is recommended that any debris / foreign objects be removed. Make sure any obstruction has been removed and any moisture has been allowed to dry, then try re-inserting the wall plug adapter into the Mobile Connector and then connecting to the power source (wall outlet).

Also make sure the wall plug adapter is not covered by anything, and that there is no heat source nearby. If the alert persists in normal ambient temperatures (under 38°C), and occurs during multiple charging attempts, this may indicate a condition affecting the Mobile Connector or your vehicle. It is recommended that you schedule service at your convenience.



Troubleshooting Alerts

You can also try charging your vehicle using a Tesla Supercharger or Destination Charging location, all of which can be located through the map on your vehicle's touchscreen display. See [Maps and Navigation on page 159](#) for more details.

For more information on troubleshooting Mobile Connector status lights and charging issues, refer to the [product's owner's manual](#).

VCFRONT_a180 **Electrical system power reduced** **Vehicle may shut down unexpectedly**

What this alert means:

The electrical system cannot maintain the voltage required to support all vehicle features.

If this alert is present while you are driving, it is possible your vehicle will shut down unexpectedly.

If this alert is present when your vehicle is in Park or when it first wakes, it is possible your vehicle may not have adequate electrical power to start driving. A separate vehicle alert may be present to indicate that condition.

What to do:

It is recommended that you eliminate or reduce your use of any non-essential features. This can help your vehicle maintain adequate electrical power for essential functions.

If this alert remains active, schedule service immediately. Without service, your vehicle may shut down unexpectedly or may not restart.

VCFRONT_a182 **Schedule service to replace low voltage battery** **Software will not update until battery is replaced**

What this alert means:

The low voltage battery is showing degraded performance and needs to be replaced. Until the low voltage battery is replaced, vehicle software updates will not complete.

What to do:

It is recommended that you have the low voltage battery replaced at your earliest convenient opportunity.

You can schedule service via your Tesla Mobile App, or with an independent service provider that offers low voltage battery replacement for your vehicle. Please note that independent service provider options may vary, based on your vehicle configuration and your location.

If the low voltage battery does not have enough electrical power to turn on your vehicle or open the doors, follow the instructions in [Jump Starting on page 223](#).

For more information on the battery system, see [High Voltage Battery Information on page 171](#).

VCFRONT_a191 **Electrical system power reduced** **Vehicle shutting down**

What this alert means:

The low voltage battery cannot provide the electrical support necessary to drive or continue driving. Your vehicle is shutting down to preserve energy for essential functions other than driving.

Your vehicle cannot be driven or continue driving while this condition continues.



What to do:

If this alert is present while you are driving, your vehicle needs to come to a stop immediately. It is recommended that you:

- Pull over safely immediately
- Use your Mobile App to contact Tesla Roadside Assistance immediately, or seek other roadside assistance if preferred

If you do not pull over safely within a short time, your vehicle may shut down unexpectedly. It is also possible that your vehicle will not restart once parked.

When this alert is present, the electrical system cannot maintain the voltage required to support all vehicle features. Many vehicle functions may no longer work.

It is possible your vehicle may lose all electrical power. If this occurs, you can still use the manual door releases to exit the vehicle if necessary. For more information, see [Opening Doors from the Interior on page 22](#).

This alert may be present due to various vehicle conditions. For more information and further recommended actions, check for other active vehicle alerts.

If this alert remains present, it is recommended that you schedule service immediately. Without service, your vehicle may not drive, may shut down unexpectedly, or may not restart.

VCFRONT_a192

Electrical system is unable to support all features Switching off features to conserve energy

What this alert means:

The electrical system cannot support all vehicle features. Your vehicle is shutting down nonessential features to preserve energy for essential functions.

If you are driving when this alert is present, it is possible your vehicle may shut down unexpectedly. It is also possible that your vehicle will not restart once parked.

Nonessential features may be unavailable, including seat heaters, cabin climate control, and in-vehicle entertainment. This is expected behavior intended to help your vehicle maintain adequate electrical power for essential functions, including the ability to operate headlights, windows and doors, hazard lights, and the front trunk (frunk).

It is possible your vehicle may lose all electrical power. If this occurs, you can still use the manual door releases to exit the vehicle if necessary. For more information, see [Opening Doors from the Interior on page 22](#).

What to do:

This alert may be present due to various vehicle conditions. For more information and further recommended actions, check for other active vehicle alerts.

VCFRONT_a216

Vehicle may not restart - Service is required Electrical system issue detected

What this alert means:

An abnormally large and sustained power draw while driving or Supercharging / DC Fast Charging has made your vehicle's electrical system unable to support all features and functions.

Your vehicle will not restart until the electrical system has been serviced.

Cabin climate control and air vent positioning, powered trunk liftgate, and steering column adjustments may be limited or unavailable.

Other features and functions may also be unavailable, or their performance may be affected. These include:



- Powered doors
- Powered windows
- Front seat (movement and heating)
- Rear seat heaters
- Side mirror movement

What to do:

It is recommended that you schedule service at your earliest opportunity. Without service, your vehicle will remain unable to restart, and the electrical system will remain unable to support all features and functions.

Some or all of the powered doors and windows in your vehicle may lose electrical power. If this occurs, you can still use the manual door releases to exit the vehicle if necessary. For more information, see [Opening Doors from the Interior on page 22](#).

VCFRONT_a220

Electrical system is unable to support all features

Schedule service

What this alert means:

The low voltage battery is not available and cannot provide electrical support for vehicle features.

It is possible your vehicle will shut down unexpectedly. It is also possible that your vehicle will not restart after the current drive.

You may notice that some nonessential features are not available. This is expected behavior due to your vehicle preserving energy for essential functions.

What to do:

It is recommended that you eliminate or reduce your use of any nonessential features. This can help your vehicle maintain adequate electrical power for essential functions other than driving, until it can be serviced.

If this alert remains present, it is recommended that you schedule service immediately. Without service, your vehicle may not drive, may shut down unexpectedly, or may not restart.

VCFRONT_a402

Electrical system backup power is unavailable

Vehicle will consume more energy while idle

What this alert means:

The backup power source for the electrical system, the low voltage battery, is not available or cannot provide the voltage required to support all vehicle features.

The primary source of electrical power, the high voltage battery system, will continue to support vehicle functions, even when your vehicle is idle. For more information on the high voltage battery, see [High Voltage Battery Information on page 171](#).

You may notice that some nonessential features are not available. This is expected behavior due to your vehicle preserving energy for essential functions.

You may also notice that your vehicle consumes more energy than usual when you are not driving it, or that your vehicle displays a lower projected range than you would normally expect after charging. This is normal vehicle behavior when this alert is present, and it will continue until the backup power source is restored.

There is a chance that an issue affecting the primary power source could cause your vehicle to shut down unexpectedly.

What to do:



It is recommended that you limit or avoid the use of any nonessential features. This can help your vehicle maintain adequate electrical power for essential functions.

It is recommended that you schedule service at your earliest opportunity, so the backup power source for the electrical system can be restored.

VCFRONT_a496 **Vehicle is preparing to shut down** **PULL OVER SAFELY**

What this alert means:

The electrical system cannot provide adequate support to drive or continue driving. Your vehicle is preparing to shut down to preserve energy for essential functions other than driving.

Your vehicle cannot be driven or continue driving while this condition continues.

What to do:

If this alert is present while you are driving, your vehicle needs to come to a stop as soon as possible. It is recommended that you:

- Pull over safely at your earliest opportunity
- Use your Mobile App to contact Tesla Roadside Assistance immediately, or seek other roadside assistance if preferred

If you do not pull over safely within a short time, your vehicle may shut down unexpectedly. It is also possible that your vehicle will not restart once parked.

It is possible your vehicle may lose all electrical power. If this occurs, you can still use the manual door releases to exit the vehicle if necessary. For more information, see [Opening Doors from the Interior on page 22](#).

This alert may be present due to various vehicle conditions. For more information and further recommended actions, check for other active vehicle alerts.

VCFRONT_a592 **Unable to drive - Service is required** **Electrical system issue detected**

What this alert means:

An abnormally large and sustained power draw has made your vehicle's electrical system unable to support all features and functions.

While this alert is present, your vehicle is unable to drive and will not restart.

Cabin climate control, powered trunk liftgate, and steering column adjustments may be limited or unavailable. Many features and functions on the left side of your vehicle may be unavailable, or their performance may be affected. These include:

- Powered doors
- Powered windows
- Front seat (movement and heating)
- Rear seat heaters
- Side mirror movement

What to do:

Without service, your vehicle will remain unable to drive, and the electrical system will remain unable to support all features and functions.



Troubleshooting Alerts

Some or all of the powered doors and windows in your vehicle may lose electrical power. If this occurs, you can still use the manual door releases to exit the vehicle if necessary. For more information, see [Opening Doors from the Interior on page 22](#).

VCFRONT_a593

Unable to drive - Service is required Electrical system issue detected

What this alert means:

An abnormally large and sustained power draw has made your vehicle's electrical system unable to support all features and functions.

While this alert is present, your vehicle is unable to drive and will not restart.

Cabin climate control, powered trunk liftgate, and steering column adjustments may be limited or unavailable. Many features and functions on the left side of your vehicle may be unavailable, or their performance may be affected. These include:

- Powered doors
- Powered windows
- Front seat (movement and heating)
- Rear seat heaters
- Side mirror movement

What to do:

Without service, your vehicle will remain unable to drive, and the electrical system will remain unable to support all features and functions.

Some or all of the powered doors and windows in your vehicle may lose electrical power. If this occurs, you can still use the manual door releases to exit the vehicle if necessary. For more information, see [Opening Doors from the Interior on page 22](#).

VCFRONT_a596

Unable to drive - Service is required Electrical system issue detected

What this alert means:

An abnormally large and sustained power draw has made your vehicle's electrical system unable to support all features and functions.

While this alert is present, your vehicle is unable to drive and will not restart.

Air vent positioning may be limited or unavailable. Many features and functions on the right side of your vehicle may be unavailable, or their performance may be affected. These include:

- Powered doors
- Powered windows
- Front seat (movement and heating)
- Rear seat heaters
- Side mirror movement

What to do:

It is recommended that you schedule service at your earliest opportunity. Without service, your vehicle will remain unable to drive, and the electrical system will remain unable to support all features and functions.



Some or all of the powered doors and windows in your vehicle may lose electrical power. If this occurs, you can still use the manual door releases to exit the vehicle if necessary. For more information, see [Opening Doors from the Interior on page 22](#).

VCFRONT_a597

Unable to drive - Service is required Electrical system issue detected

What this alert means:

An abnormally large and sustained power draw has made your vehicle's electrical system unable to support all features and functions.

While this alert is present, your vehicle is unable to drive and will not restart.

Air vent positioning may be limited or unavailable. Many features and functions on the right side of your vehicle may be unavailable, or their performance may be affected. These include:

- Powered doors
- Powered windows
- Front seat (movement and heating)
- Rear seat heaters
- Side mirror movement

What to do:

It is recommended that you schedule service at your earliest opportunity. Without service, your vehicle will remain unable to drive, and the electrical system will remain unable to support all features and functions.

Some or all of the powered doors and windows in your vehicle may lose electrical power. If this occurs, you can still use the manual door releases to exit the vehicle if necessary. For more information, see [Opening Doors from the Interior on page 22](#).

VCSEC_a221

Air pressure below recommendation for tires Check pressure and refill air as needed

What this alert means:

This alert does NOT indicate that there is a flat tire.

The tire pressure monitoring system (TPMS) has detected that the air pressure in one or more of your tires is at least 20% lower than the recommended cold tire pressure.

See [Maintaining Tire Pressures on page 185](#) for detailed information on where to find the recommended cold pressure (RCP) for your vehicle's tires, how to check tire pressures, and how to keep your tires properly inflated.

This alert may appear in cold weather because the air in your tires naturally contracts when it becomes cold, decreasing tire pressures.

What to do:

Add air to maintain the recommended cold tire pressure. Although drops in tire pressure are expected in colder weather, the recommended cold tire pressure should be maintained at all times.

The alert may clear as the vehicle is driven. This is because the tires will warm up and the tire pressure will increase. Even if the alert clears, the tires should still be refilled with air once they have cooled.

The alert will clear once the Tire Pressure Monitoring System detects that each of your tires is inflated to the recommended cold pressure.



Troubleshooting Alerts

- The alert and Tire Pressure indicator light may still be present immediately after you have filled your tires to the recommended cold pressure, but both should clear once you have driven a short distance.
- You may need to drive over 15 mph (25 km/h) for at least 10 minutes for the Tire Pressure Monitoring System to measure and report your updated tire pressures.

If you repeatedly see this alert for the same tire, have the tire inspected for a slow leak. You can visit a local tire shop or schedule service using your Tesla Mobile App.

For more information on tire pressure and inflation, see [Tire Care and Maintenance on page 185](#).

VCSEC_a228

Air pressure in tires very low

PULL OVER SAFELY - Check for flat tire

What this alert means:

This alert indicates that one or more of the tires on your vehicle is extremely low or flat.

The tire pressure monitoring system (TPMS) has detected that the air pressure in one or more of your tires is significantly lower than the recommended cold tire pressure.

What to do:

You should pull over carefully as soon as possible. In a safe location, check for a flat tire.

You can request Tesla roadside assistance options (mobile tire, loaner wheel, tow) if required. See [Contacting Tesla Roadside Assistance on page 220](#) for more information.

In a non-emergency situation, it is recommended that you visit a local tire shop for assistance or schedule service using your Tesla Mobile App.

See [Maintaining Tire Pressures on page 185](#) for detailed information on where to find the recommended cold pressure (RCP) for your vehicle's tires, how to check tire pressures, and how to keep your tires properly inflated.

The alert should clear once the Tire Pressure Monitoring System has a consistent tire pressure measurement for each of your tires of at least 30 psi.

- The alert and Tire Pressure indicator light may still be present immediately after you have filled your tires to the recommended cold pressure, but both should clear once you have driven a short distance.
- You may need to drive over 15 mph (25 km/h) for at least 10 minutes for the Tire Pressure Monitoring System to measure and report your updated tire pressures.

For more information on tire pressure and inflation, see [Tire Care and Maintenance on page 185](#).



Document Applicability

For the latest and greatest information that is customized to your vehicle, view the Owner's Manual on your vehicle's touchscreen by touching **Controls > Service > Owner's Manual**. The information is specific to your vehicle depending on the features you purchased, vehicle configuration, market region and software version. In contrast, owner information that is provided by Tesla elsewhere is updated as necessary and may not contain information unique to your vehicle.

Information about new features is displayed on the touchscreen after a software update, and can be viewed at any time by touching **Controls > Software > Release Notes**. If the content in the Owner's Manual on how to use your vehicle conflicts with information in the Release Notes, the Release Notes take precedence.

Illustrations

The illustrations provided in this document are for demonstration purposes only. Depending on vehicle options, software version and market region, the information displayed on the touchscreen in your vehicle may appear slightly different.

Feature Availability

Some features are available only on some vehicle configurations and/or only in specific market regions. Options or features mentioned in the Owner's Manual does not guarantee they are available on your specific vehicle. See [Feature Availability Statement on page 280](#) for more information.

Errors or Inaccuracies

All specifications and descriptions are known to be accurate at time of publishing. However, because continuous improvement is a goal at Tesla, we reserve the right to make product modifications at any time. To communicate any inaccuracies or omissions, or to provide general feedback or suggestions regarding the quality of the Owner's Manual, send an email to ownersmanualfeedback@tesla.com.

Location of Components

Owner information may specify the location of a component as being on the left or right side of the vehicle. As shown, left (1) and right (2) represent the side of the vehicle when sitting inside.



Copyrights and Trademarks

© 2012–2024 Tesla, Inc. All information in this document and all vehicle software is subject to copyright and other intellectual property rights of Tesla, Inc. and its licensors. This material may not be modified, reproduced or copied, in whole or in part, without the prior written permission of Tesla, Inc. and its licensors. Additional information is available upon request. Tesla uses software created by the Open Source community. Please visit Tesla's Open Source software website at www.tesla.com/opensource. HD Radio is a registered trademark of iBiquity Digital Corporation. The following are trademarks or registered trademarks of Tesla, Inc. in the United States and other countries:

TESLA

TESLA MOTORS

TESLA ROADSTER

MODEL S

MODEL X

MODEL 3

MODEL Y

CYBERTRUCK

T E S L A



All other trademarks contained in this document are the property of their respective owners and their use herein does not imply sponsorship or endorsement of their products or services. The unauthorized use of any trademark displayed in this document or on the vehicle is strictly prohibited.



Feature Availability Statement

Your Tesla is constantly changing, with new features being added and improved upon with every software update. However, depending on the firmware release operating on your vehicle, your vehicle may not be equipped with all features or may not operate exactly as described in this Owner's Manual. The features on your vehicle vary depending on market region, vehicle configuration, options purchased, software updates, and more.

Referencing options or features mentioned in this Owner's Manual does not guarantee they are available on your specific vehicle. The best way to ensure you are getting the latest and greatest features is update your vehicle's software as soon as you receive the notification to do so. You can also set your preferences to **Controls > Software > Software Preferences > Advanced**. See [Software Updates on page 182](#) for more information. For the features available on your vehicle, always comply with local laws and limits to ensure the safety of you, your passengers, and those around you.

Vehicle Telematics

Model Y is equipped with electronic modules that monitor and record data from various vehicle systems, including the motor, Autopilot components, Battery, braking and electrical systems. The electronic modules record information about various driving and vehicle conditions, including braking, acceleration, trip and other related information regarding your vehicle. These modules also record information about the vehicle's features such as charging events and status, the enabling/disabling of various systems, diagnostic trouble codes, VIN, speed, direction and location.

The data is stored by the vehicle and may be accessed, used and stored by Tesla service technicians during vehicle servicing or periodically transmitted to Tesla wirelessly through the vehicle's telematics system. This data may be used by Tesla for various purposes, including, but not limited to: providing you with Tesla telematics services; troubleshooting; evaluation of your vehicle's quality, functionality and performance; analysis and research by Tesla and its partners for the improvement and design of our vehicles and systems; to defend Tesla; and as otherwise may be required by law. In servicing your vehicle, Tesla can potentially resolve issues remotely simply by reviewing your vehicle's data log.

Tesla's telematics system wirelessly transmits vehicle information to Tesla on a periodic basis. The data is used as previously described and helps ensure the proper maintenance of your vehicle. Additional Model Y features may use your vehicle's telematics system and the information provided, including features such as charging reminders, software updates, and remote access to, and control of, various systems of your vehicle.

Tesla does not disclose the data recorded in your vehicle to any third party except when:

- An agreement or consent from the vehicle's owner (or the leasing company for a leased vehicle) is obtained.
- Officially requested by the police or other authorities.
- Used as a defense for Tesla.
- Ordered by a court of law.
- Used for research purposes without disclosing details of the vehicle owner or identification information.
- Disclosed to a Tesla affiliated company, including their successors or assigns, or our information systems and data management providers.

For additional information regarding how Tesla processes data collected from your vehicle, please review Tesla's Privacy Notice at <http://www.tesla.com/about/legal>.

Data Sharing

For quality assurance and to support the continuous improvement of advanced features such as Autopilot, your Model Y may collect analytics, road segment, diagnostic, and vehicle usage data and send to Tesla for analysis. This analysis helps Tesla improve products and services by learning from the experience of billions of miles that Tesla vehicles have driven. Although Tesla shares this data with partners that contribute similar data, the collected information does not identify you personally and can be sent to Tesla only with your explicit consent. In order to protect your privacy, personal information is either not logged at all, is subject to privacy preserving techniques, or is removed from any reports before being sent to Tesla. You have control over what data you share by touching **Controls > Software > Data Sharing**.

For additional information regarding how Tesla processes data collected from your vehicle, please review Tesla's Privacy Notice at <http://www.tesla.com/about/legal>.

NOTE: Although Model Y uses GPS in connection with driving and operation, as discussed in this document, Tesla does not record or store vehicle-specific GPS information, except the location where a crash occurred. Consequently, Tesla is unable to provide historical information about a vehicle's location (for example, Tesla is unable to tell you where Model Y was parked/traveling at a particular date/time).

Quality Control

You might notice a few km on the odometer when you take delivery of your Model Y. This is a result of a comprehensive testing process that ensures the quality of your Model Y.

The testing process includes extensive inspections during and after production. The final inspection takes place at Tesla and includes a road test conducted by a technician.

Sound Library

"Free Sounds Library" (if equipped).

Free Sound Effects Site.

License: Attribution 4.0 International (CC BY 4.0). You are allowed to use sound effects free of charge and royalty free in your multimedia projects for commercial or non-commercial purposes.

<http://www.freesoundslibrary.com>



Contacting Tesla

For detailed information about your Model Y, go to <http://www.tesla.com>, and log on to your Tesla account, or sign up to get an account.

If you have any questions or concerns about your Model Y, call Tesla at 0800 005 431.

NOTE: You can also use voice commands to provide feedback to Tesla. Say "Report", "Feedback", or "Bug report" followed by brief comments. Model Y takes a snapshot of its systems, including your current location, vehicle diagnostic data, and screen captures of the touchscreen. Tesla periodically reviews these notes and uses them to continue improving Model Y.



FCC and ISED Certification

Component	Manufacturer	Model	Operating Frequency (MHz)	FCC ID	IC ID
B-Pillar Endpoint	Tesla	1783148Y	13.56 2400-2483.5	2AEIM-1783148Y	20098-1783148Y
Center Console	Tesla	1089774	13.56 2400-2483.5	2AEIM-1089774	20098-1089774
Rear Endpoint	Tesla	1509516	2400-2483.5	2AEIM-1509516	20098-1509516
Key fob	Tesla	1133148	2400-2483.5	2AEIM-1133148	20098-1133148
TPMS	Tesla	1472547G	2400-2483.5	2AEIM-1472547G	20098-1472547G
In-Cabin Radar* (if equipped)	Tesla	1616631	60000-64000	2AEIM-1616631	20098-1616631
Homelink (if equipped)	Gentex	ADHL5C	286-440MHz	NZLADHL5C	4112A-ADHL5C
Car PC	Tesla	1960400		XMR2020AG525RGL XMR202201AF51Y	10224A-2020AG525R 10224A-202201AF51Y
Wireless Charger	Tesla	WC3	127.72KHz	2AEIM-WC3	20098-WC3

*In-cabin radar is restricted to factory installation.

The devices listed above comply with Part 15 of the FCC rules and Industry Canada's license-exempt RSS Standard(s) and EU Directive 2014/53/EU.

Operation is subject to the following two conditions:

1. This device may not cause harmful interference; and
2. This device must accept any interference received, including interference that may cause undesired operation.

Changes or modifications not expressly approved by Tesla could void your authority to operate the equipment.

Radio Frequency Information

This equipment has been tested and found to comply with the limits for a Class B digital device, pursuant to Part 15 of the FCC Rules. These limits are designed to provide reasonable protection against harmful interference in a residential installation. This equipment generates, uses and can radiate radio frequency energy and, if not installed and used in accordance with the instructions, may cause harmful interference to radio communications. However, there is no guarantee that interference will not occur in a particular installation. If this equipment does cause harmful interference to radio or television reception, which can be determined by turning the equipment off and on, try to correct the interference by one or more of the following measures:

- Reorient or relocate the receiving antenna.
- Increase the separation between the equipment and receiver.



Certification Conformity

- Connect the equipment into an outlet on a circuit different from that to which the receiver is connected.
- Consult the dealer or an experienced radio/TV technician to help.

 **CAUTION:** This equipment and its antennas must not be co-located or operated with another antenna or transmitter.

Radiation Exposure Statement

The products comply with the FCC/ISED RF Exposure for Low Power Consumer Wireless Power Transfer. RF exposure limits are set forth for an uncontrolled environment and are safe for intended operation as described in this manual. The farthest RF exposure demonstrated by compliance was at 20cm and farther from the user's body; set the device to low output power if such function is available.

Device Approval - Australia, New Zealand



**A**

ABS (Anti-lock Braking System): [85](#)
absolute speed limit: [140](#)
acceleration, chill: [93](#)
acceleration, sport: [93](#)
acceleration, standard: [93](#)
accessories: [10](#)
 plugging into power socket: [10](#)
accessories, towing: [101](#)
adjacent lane speed: [108](#)
aero covers: [187](#)
air conditioning: [149](#)
air filter: [154](#)
airbag safety information: [63](#)
airbags, location: [61](#)
alarm: [142](#), [146](#)
all-season tires: [190](#)
Always Show Estimated Round Trip Energy: [163](#)
ambient lights: [81](#)
anti-lock braking (ABS): [85](#)
apps: [5](#)
Arcade: [167](#)
audio: [75](#), [165](#), [167](#)
 playing files: [165](#), [167](#)
 settings: [165](#)
 steering wheel scroll button: [75](#)
 volume control: [165](#)
auto fold: [77](#)
Auto Lane Change: [108](#)
auto tilt: [77](#)
AUTO wipers: [84](#)
automatic emergency braking: [138](#)
automatic navigation: [159](#)
 navigating: [159](#)
Autopark: [123](#)
autopilot: [134](#)
 side collision warning: [134](#)
Autopilot: [106](#), [108](#), [123](#), [125](#), [137](#), [140](#)
 automatic emergency braking: [137](#)
 Autopark: [123](#)
 Autosteer: [108](#)
 collision avoidance assist: [137](#)
 forward collision warning: [137](#)
 overtake acceleration: [108](#)
 overview: [106](#)
 speed assist: [140](#)
 speed limit warning: [140](#)
 staying within speed limits: [140](#)
 Summon: [125](#)

Traffic-Aware Cruise Control: [108](#)

Autopilot components: [106](#)

Autosteer: [108](#)

average range: [181](#)

B

backup camera: [99](#)

Battery (high voltage): [171](#), [214](#)

 specifications: [214](#)

 temperature limits: [171](#)

battery (key), replacing: [20](#)

battery (low voltage): [171](#), [214](#)

 complete discharge: [171](#)

 specifications: [214](#)

Blind Spot Camera: [134](#)

Blind Spot Collision Warning: [134](#)

Blind Spot Collision Warning Chime: [134](#)

Bluetooth: [67](#), [69](#), [167](#)

 devices, playing audio files from: [167](#)

 general information: [67](#), [69](#)

 phone, pairing and using: [67](#)

body repairs: [199](#)

body touch up: [194](#)

Boombox: [167](#), [168](#)

booster seats: [38](#)

booster seats, child safety: [48](#)

brakes: [85](#), [138](#), [212](#)

 automatic in emergencies: [138](#)

 overview of: [85](#)

 specifications: [212](#)

Bumper Clearance (Summon): [125](#)

C

cabin air filter: [154](#)

cabin camera: [141](#)

cabin temperature control: [149](#)

Calendar: [69](#)

calibrating windows: [24](#)

camera, rear-facing: [99](#)

Camp: [151](#)

car cover: [195](#)

car wash mode: [192](#)

car washes: [192](#)

Caraoke): [167](#)

card: [18](#)

cargo area: [26](#)

cargo volume specifications: [212](#)

carpets, cleaning: [194](#)

CCS (Combo): [170](#)

certifications (FCC, ISED, CE, NCC): [283](#)



- CHAdemo: [170](#)
- chains: [190](#)
- change of ownership: [8](#)
- charge port: [173](#)
- charge port light: [174](#)
- charge port manual release: [176](#)
- charge port release cable: [176](#)
- charging: [170](#), [173](#), [174](#), [175](#)
 - charge settings: [174](#), [175](#)
 - charging status: [174](#), [175](#)
 - components and equipment: [170](#)
 - instructions: [173](#)
 - public charging stations: [170](#)
 - scheduling: [174](#), [175](#)
- charging locations, finding: [162](#)
- charging stations, displaying on map: [159](#)
- child protection: [24](#)
 - disabling rear window switches: [24](#)
- child restraint systems: [38](#)
- child restraint systems, seating: [48](#)
- child safety seats: [38](#)
- cleaning: [192](#)
- climate controls: [149](#)
- coat hangers: [29](#)
- cold weather: [155](#)
- cold weather best practices: [155](#)
- collision avoidance assist: [137](#)
- Colorizer: [167](#)
- connecting to Wi-Fi: [66](#)
- console: [9](#), [10](#), [29](#)
 - low voltage power socket: [10](#)
 - opening: [29](#)
 - rear: [29](#)
 - USB ports: [9](#)
- consumption chart: [181](#)
- contact information: [221](#)
 - roadside assistance: [221](#)
- copyrights: [279](#)
- cruise control: [108](#)

D

- dashboard overview: [5](#)
- Dashcam: [144](#)
- data recording: [281](#)
- data sharing: [281](#)
- delivery mileage: [281](#)
- devices: [167](#)
 - Bluetooth, playing audio files: [167](#)
- dimensions, interior: [212](#)
- dimensions, overhand: [210](#)

- dimensions, specifications: [210](#)
- display settings: [5](#)
- Dog: [151](#)
- dome (map) lights: [81](#)
- door handles: [22](#)
- door labels: [210](#)
- door seals: [194](#)
 - cleaning: [194](#)
- doors: [22](#), [23](#), [225](#)
 - Child Lock: [23](#)
 - exterior door handles: [22](#)
 - interior locking and unlocking: [22](#)
 - locking: [22](#)
 - opening from exterior: [22](#)
 - opening from interior: [22](#), [225](#)
 - opening with no power: [225](#)
 - Unlock on Park: [23](#)
 - unlocking: [22](#)
- doors function: [22](#)
 - Walk-Away Door Lock: [22](#)
- drive away locking: [23](#)
- drive mode, Drive: [79](#)
- drive mode, Neutral: [79](#)
- drive mode, Park: [79](#)
- drive mode, Reverse: [79](#)
- drive modes, shifting: [79](#)
- driver: [96](#)
 - profiles: [96](#)
- driver assistance: [106](#)
- driving: [31](#), [74](#), [180](#)
 - seating position: [31](#)
 - starting: [74](#)
 - tips to maximize range: [180](#)

E

- easy entry, driver profile: [96](#)
- electric parking brake: [87](#)
- emergency braking: [137](#)
- emergency flashers: [83](#)
- Emergency Lane Departure Avoidance: [134](#)
- energy: [11](#), [86](#)
 - gained from regenerative braking: [86](#)
 - range information: [11](#)
- Energy app: [181](#)
- energy use predictions (navigating): [163](#)
- Entertainment: [167](#)
- Erase & Reset: [8](#)
- event data recording: [281](#)
- exterior: [3](#), [81](#), [192](#), [194](#), [195](#)
 - car cover: [195](#)



- cleaning: [192](#)
- lights: [81](#)
- overview: [3](#)
- polishing, touch up, & repair: [194](#)

exterior dimensions: [210](#)

F

- factory defaults, restoring: [8](#)
- factory reset: [8](#)
- favorites (Media Player): [167](#)
- Favorites (navigation): [159](#)
- FCC & ISED certifications: [283](#)
- feature availability: [280](#)
- features, downloading new: [182](#)
- firmware (software) updates: [182](#)
- flash drive: [144](#), [146](#)
- flashers, warning: [83](#)
- floor mats: [195](#)
- fluids: [184](#)
 - replacement intervals: [184](#)
- fog lights: [81](#)
- forward collision warning: [137](#)
- front airbag, passenger: [62](#)
- front and rear seats: [31](#)
- front trunk: [27](#), [222](#)
 - opening with no power: [222](#)

G

- gaming controllers: [167](#)
- garage doors, opening: [71](#)
- gates, opening: [71](#)
- glovebox: [29](#)
- Glovebox PIN: [143](#)

H

- hazard lights: [83](#)
- hazard warning flashers: [83](#)
- hazards: [83](#)
- head supports: [33](#)
- headlights: [81](#), [82](#)
 - after exit: [82](#)
 - controlling: [81](#)
 - high beams: [82](#)
- heating: [149](#)
- high beam headlights: [82](#)
- high voltage: [170](#), [184](#), [214](#)
 - Battery specifications: [214](#)
 - components: [170](#)
 - safety: [184](#)
- hills, stopping on: [91](#)

- Home: [5](#)
 - button: [5](#)
 - screen: [5](#)
- Home location: [161](#)
- HomeLink: [71](#), [125](#)
 - programming and using: [71](#)
 - when using Summon: [125](#)
- hood: [27](#), [222](#)
 - opening with no power: [222](#)
- horn: [76](#)
- hub caps: [187](#)

I

- i-Size: [38](#)
- I'm Feeling Lucky, Hungry: [159](#)
- identification labels: [207](#)
- instant range: [181](#)
- interior: [5](#), [81](#), [149](#), [193](#)
 - cleaning: [193](#)
 - lights: [81](#)
 - overview: [5](#)
 - temperature control: [149](#)
- interior cabin camera: [141](#)
- intrusion detection: [142](#)
- ISOFIX: [38](#)
- ISOFIX, child safety seats: [48](#)

J

- J1772: [170](#)
- jacking: [198](#)
- jump start: [221](#), [223](#)

K

- Keep Climate On: [151](#)
- key: [20](#)
 - replacing battery: [20](#)
- key card: [18](#)
- keys: [18](#), [20](#)
 - adding key cards and phone keys: [20](#)
 - deleting key cards and phone keys: [20](#)
 - displaying a list of: [20](#)
 - overview: [18](#)

L

- label: [210](#)
 - Statutory Plate: [210](#)
 - Tire Information: [210](#)
- lane assist: [134](#)
- Lane Departure Avoidance: [134](#)
- liftgate: [25](#)



- adjust opening height: [25](#)
- opening: [25](#)
- lifting: [198](#)
- lights: [81](#), [82](#), [83](#)
 - hazard warning: [83](#)
 - headlights after exit: [82](#)
 - turn signals: [83](#)
- load limits: [210](#)
- location tracking: [159](#)
- locking: [22](#)
- lug nut covers: [188](#)
- lumbar adjustment: [31](#)

M

- maintenance: [183](#), [184](#), [185](#), [192](#), [196](#), [197](#)
 - cleaning: [192](#)
 - daily checks: [183](#)
 - fluid replacement intervals: [184](#)
 - monthly checks: [183](#)
 - periodic checks: [184](#)
 - replacing wiper blades: [196](#)
 - service intervals: [183](#)
 - tires: [185](#)
 - washer fluid, topping up: [196](#)
 - washer jets, cleaning: [197](#)
- map orientation: [159](#)
- map updates: [164](#)
- mats: [195](#)
- media: [165](#), [167](#)
 - settings: [165](#)
 - sources, show and hide: [165](#)
- mileage upon delivery: [281](#)
- mirrors: [77](#)
- mobile app: [64](#)
- mobile app access: [64](#)
- Mobile Connector: [170](#), [173](#)
 - description: [170](#)
 - using: [173](#)
- modifications: [199](#)
- motor specifications: [212](#)
- My Apps: [6](#)
- my car does what?: [167](#)

N

- naming your vehicle: [8](#)
- Navigate on Autopilot: [108](#)

O

- Obstacle-Aware Acceleration: [137](#)
- occupancy sensor, front passenger: [62](#)

- odometer: [98](#)
- Off-Peak Charging: [178](#)
- off-road assist: [92](#)
- offset from speed limit: [140](#)
- Online Routing: [163](#)
- overtake acceleration: [108](#)
- Owner Information, about: [279](#)

P

- Park Assist: [89](#)
- parking brake: [87](#)
- parking, using Autopark: [123](#)
- parking, using Summon: [125](#)
- parts replacement: [199](#)
- passenger detection: [62](#)
- passenger detection, front: [62](#)
- pedestrian warning: [100](#)
- personal data, erasing: [8](#)
- phone: [18](#), [67](#), [69](#)
 - app: [69](#)
 - authenticating as a key: [18](#)
 - connecting: [67](#)
 - importing contacts: [67](#)
 - in call options: [69](#)
 - making a call: [69](#)
 - pairing: [67](#)
 - receiving a call: [69](#)
 - recent calls: [67](#)
- phone app: [69](#)
- phone key: [18](#), [20](#)
 - adding as a key: [20](#)
 - removing as a key: [20](#)
- PIN: [97](#)
- PIN to Drive: [143](#)
- power: [86](#)
 - gained from regenerative braking: [86](#)
- power cycling: [74](#)
- power socket: [10](#)
- power windows: [24](#), [206](#)
- powering on and off: [74](#)
- Preconditioning: [178](#)
- public charging stations: [170](#)

R

- radio: [165](#), [167](#)
- Radio regulatory information: [283](#)
- range: [86](#), [180](#)
 - driving tips to maximize: [180](#)
 - regenerative braking: [86](#)
- range assurance: [180](#)



- re-naming your vehicle: [8](#)
- Re-route: [163](#)
- reading light: [29](#)
- reading lights: [81](#)
- rear seats, adjusting and folding: [32](#)
- rear view camera: [99](#)
- rear window switches, disabling: [24](#)
- recent (Media Player): [167](#)
- Recents (navigation): [159](#)
- recording: [144](#), [146](#)
- regenerative braking: [86](#)
- relative speed limit: [140](#)
- release notes: [182](#)
- restarting the touchscreen: [74](#)
- RFID transponders: [199](#)
- roadside assistance: [221](#)
- roof racks: [210](#)
- rotating tires: [186](#)
- Round Trip Energy (navigating): [163](#)
- run out of range: [221](#), [223](#)
- S**
 - safety information: [37](#)
 - seat belts: [37](#)
 - Schedule: [178](#)
 - schedule service: [64](#)
 - scheduled charging: [178](#)
 - scheduled departure: [178](#)
 - using: [178](#)
 - seat belts: [35](#), [36](#), [194](#)
 - cleaning: [194](#)
 - in a collision: [36](#)
 - overview of: [35](#)
 - pre-tensioners: [36](#)
 - wearing when pregnant: [36](#)
 - seat covers: [34](#)
 - seat heaters: [149](#)
 - seating capacity: [210](#)
 - seats: [31](#), [149](#)
 - heaters: [149](#)
 - seats, child safety: [48](#)
 - second row seats, adjusting and folding: [32](#)
 - security settings: [142](#)
 - Sentry Mode: [146](#)
 - service data recording: [281](#)
 - service intervals: [183](#)
 - settings, acceleration: [93](#)
 - Settings, erasing: [8](#)
 - shifting drive modes: [79](#)
 - shortcuts: [6](#), [7](#)
 - adding to My Apps: [6](#)
 - restarting the touchscreen: [7](#)
 - Show Calendar Upon Entry: [69](#)
 - side camera(s): [99](#)
 - Side Clearance (Summon): [125](#)
 - side collision warning: [134](#)
 - slip start: [92](#)
 - Smart Summon: [127](#)
 - smartphone: [18](#)
 - authenticating as a key: [18](#)
 - Software Reinstall: [182](#)
 - software reset: [8](#)
 - software update preferences: [182](#)
 - software updates: [182](#)
 - specifications: [212](#), [214](#)
 - brakes: [212](#)
 - High Voltage Battery: [214](#)
 - low voltage battery: [214](#)
 - motor: [212](#)
 - steering: [212](#)
 - subsystems: [212](#)
 - suspension: [214](#)
 - tires: [214](#)
 - transmission: [212](#)
 - wheels: [214](#)
 - specifications, exterior: [210](#)
 - specifications, interior: [212](#)
 - speed assist: [140](#)
 - speed limit warning: [140](#)
 - stability control: [92](#)
 - standby: [146](#)
 - starting: [74](#)
 - Statutory Plate: [210](#)
 - steering specifications: [212](#)
 - steering wheel: [81](#)
 - lights, controlling: [81](#)
 - steering, automatic: [108](#)
 - summer tires: [190](#)
 - Summon: [125](#)
 - Summon Distance: [125](#)
 - Superchargers, displaying on map: [159](#)
 - Supercharging: [176](#)
 - congestion fees: [176](#)
 - described: [176](#)
 - idle fees: [176](#)
 - pay-per-use fees: [176](#)
 - suspension specifications: [214](#)
- T**
 - Technically Permissible Maximum Laden Mass: [210](#)



Technically Permissible Maximum Mass on Axle: [210](#)
telematics: [281](#)
temperature: [11](#), [76](#), [149](#), [171](#)
 Battery (high voltage), limits: [171](#)
 cabin, controls for: [149](#)
 heated steering wheel: [76](#)
 outside: [11](#)
tesla profiles: [96](#)
Teslacam: [144](#), [146](#)
tie-down straps: [219](#)
Tire Information label: [210](#)
tire noise: [190](#)
Tire Pressure Monitoring System: [189](#)
 overview of: [189](#)
tire pressures, checking: [185](#)
tire pressures, displaying: [185](#)
tires: [185](#), [186](#), [190](#), [214](#), [215](#)
 all-season: [190](#)
 balancing: [186](#)
 chains: [190](#)
 inspecting and maintaining: [185](#)
 pressures, displaying: [185](#)
 pressures, how to check: [185](#)
 replacing: [186](#)
 replacing a tire sensor: [190](#)
 rotation: [186](#)
 specification: [214](#)
 summer: [190](#)
 tire markings: [215](#)
 wheel configuration: [185](#)
 winter: [190](#)
toll system transponders, attaching: [199](#)
torque specifications: [212](#)
touch up body: [194](#)
touchscreen: [5](#), [6](#), [7](#), [75](#), [182](#), [194](#)
 adding shortcuts: [6](#)
 cleaning: [194](#)
 customizing My Apps: [6](#)
 display settings: [5](#)
 frozen: [7](#)
 main: [5](#)
 overview: [5](#)
 rear: [5](#)
 reboot: [7](#)
 restarting: [75](#)
 software updates: [182](#)
 unresponsive: [7](#)
towing: [221](#), [223](#)
towing a trailer: [101](#)
towing instructions: [217](#)

Toybox: [167](#)
TPMAM: [210](#)
TPMLM: [210](#)
TPMS: [189](#)
 overview of: [189](#)
Tracking Disabled: [159](#)
traction control: [92](#)
trademarks: [279](#)
Traffic Light and Stop Sign Control: [116](#)
Traffic-Aware Cruise Control: [108](#)
trailer, towing: [101](#)
transmission specifications: [212](#)
transponders, attaching: [199](#)
Transport Mode: [217](#)
transporting: [217](#)
trip chart: [181](#)
trip meter: [98](#)
Trip Planner: [163](#)
trunk, front: [27](#)
trunk, rear: [25](#)
turn signals: [83](#)

U

Unlock On Park: [23](#)
unlocking: [22](#)
USB devices: [9](#)
 connecting: [9](#)
USB flash drive: [142](#), [144](#), [146](#)
USB ports: [9](#)

V

Valet mode: [97](#)
vehicle dimensions: [210](#)
vehicle ground clearance: [210](#), [212](#)
Vehicle Hold: [91](#)
Vehicle Identification Number (VIN): [207](#)
vehicle loading: [210](#)
ventilation: [154](#)
vents, adjusting: [154](#)
video call: [70](#)
video clips: [144](#)
View Live Camera: [146](#)
VIN (Vehicle Identification Number): [207](#)
voice commands: [14](#)
volume control: [5](#)
volume control (media): [165](#)

W

Walk-Away Door Lock: [22](#)
Wall Connector: [170](#)



warm weather best practices: [158](#)
warning flashers: [83](#)
washer fluid, topping up: [196](#)
washer jets, cleaning: [197](#)
washers, using: [84](#)
web conferencing: [70](#)
wheel chocks: [219](#)
wheels: [186](#), [187](#), [188](#), [214](#)
 aero covers, removing and installing: [187](#)
 alignment: [186](#)
 lug nut covers, removing and installing: [188](#)
 replacing: [186](#)
 specifications: [214](#)
 torque: [214](#)
Wi-Fi, connecting to: [66](#)
windows, calibrating: [24](#)
windshield washer fluid, topping up: [196](#)
winter tires: [190](#)
wiper blades, replacing: [196](#)
wipers, using: [84](#)
Work location: [161](#)

Z

Zoom: [70](#)

TESLA

Publication date: 2024/11/1