



MODEL X

2015–2020

OWNER'S MANUAL



Software version: 2024.44.25.3
United Arab Emirates

YOUR OWNER'S MANUAL

For the latest and greatest information that is customized to your vehicle, view the Owner's Manual on your vehicle's touchscreen by touching the app launcher and then selecting the Manual app. The information is specific to your vehicle depending on the features you purchased, vehicle configuration, market region, and software version. In contrast, owner information that is provided by Tesla elsewhere is updated as necessary and may not contain information unique to your vehicle.

RELEASE NOTES

Information about new features is displayed on the touchscreen after a software update, and can be viewed at any time by choosing the **Release Notes** tab in the Manual app, or by touching **Controls > Software > Release Notes**. If the content in the Owner's Manual on how to use your vehicle conflicts with information in the Release Notes, the Release Notes take precedence.

ILLUSTRATIONS AND PRODUCT SPECIFICATIONS

The illustrations provided in this document are for demonstration purposes only. Depending on vehicle options, software version and market region, the information displayed on the touchscreen in your vehicle may appear slightly different.

All specifications and descriptions contained in this document are verified to be accurate at the time of printing. However, because continuous improvement is a goal at Tesla, we reserve the right to make product modifications at any time. To communicate any inaccuracies or omissions in this document, please send an email to: ownersmanualfeedback@tesla.com.

SAFETY INFORMATION

You can find safety information in your Model X Owner's Manual on the touchscreen.

For detailed information about your Model X, go to the Tesla website for your region, log on to your Tesla account, or sign up to get an account.

If you have any questions or concerns about your Model X, call Tesla. To find the number for your region, go to www.tesla.com, select your region at the bottom of the page, then view contact information.

© 2012-2025 TESLA, INC.

All information in this document and all vehicle software is subject to copyright and other intellectual property rights of Tesla, Inc. and its licensors. This material may not be modified, reproduced or copied, in whole or in part, without the prior written permission of Tesla, Inc. and its licensors. Additional information is available upon request. Shown here are trademarks or registered trademarks of Tesla, Inc. in the United States and other countries:

MODEL 3

MODEL S

TESLA

TESLA ROADSTER

MODEL Y

MODEL X

TESLA MOTORS

T E S L A





Overview	3	About Autopilot.....	112
Exterior.....	3	Autopilot Features.....	114
Interior.....	4	Traffic-Aware Cruise Control.....	118
Touchscreen.....	6	Autopark.....	123
Interior Electronics.....	10	Summon.....	125
Instrument Panel.....	11	Smart Summon.....	128
Voice Commands.....	17	Limitations and Warnings.....	131
Cameras.....	19		
Opening and Closing	20	Active Safety Features	135
Keys and Doors.....	20	Lane Assist.....	135
Windows.....	28	Collision Avoidance Assist.....	138
Sun Visors.....	29	Speed Assist.....	141
Storage Areas	30	Dashcam, Sentry, and Security	143
Rear Trunk.....	30	Safety & Security Settings.....	143
Front Trunk.....	32	Dashcam.....	145
Interior Storage.....	34	Sentry Mode.....	146
		USB Drive Requirements for Recording Videos.....	148
Seating and Safety Restraints	36	Climate	149
Front and Rear Seats.....	36	Operating Climate Controls.....	149
Seat Belts.....	41	Vents.....	154
Child Safety Seats.....	44	Cold Weather Best Practices.....	155
Airbags.....	61	Hot Weather Best Practices.....	157
Connectivity	66	Navigation and Entertainment	158
Mobile App.....	66	Maps and Navigation.....	158
Wi-Fi.....	68	Media.....	163
Bluetooth.....	69	Theater, Arcade, and Toybox.....	165
Phone, Calendar, and Web Conferencing.....	71		
Smart Garage.....	73	Charging and Energy Consumption	168
Driving	76	Electric Vehicle Components.....	168
Starting and Powering Off.....	76	High Voltage Battery Information.....	170
Steering Wheel.....	77	Charging Instructions.....	172
Mirrors.....	80	Scheduled Precondition and Charge.....	178
Shifting.....	82	Getting Maximum Range.....	180
Lights.....	83		
Wipers and Washers.....	85	Maintenance	182
Braking and Stopping.....	86	Software Updates.....	182
Air Suspension.....	90	Maintenance Service Intervals.....	183
Park Assist.....	92	Tire Care and Maintenance.....	185
Vehicle Hold.....	94	Cleaning.....	191
Traction Control.....	95	Windshield Wiper Blades, Jets and Fluid.....	195
Acceleration Modes.....	96	Jacking and Lifting.....	197
Driver Profiles.....	98	Parts and Accessories.....	198
Trip Information.....	100	Temporary Tire Repair Kit.....	199
Rear Facing Camera(s).....	101	Do It Yourself Maintenance.....	201
Pedestrian Warning System.....	102		
Active Spoiler.....	103	Specifications	202
Towing and Accessories.....	104	Identification Labels.....	202
		Vehicle Loading.....	203
Autopilot	112	Dimensions.....	204
		Subsystems.....	206



Contents

Wheels and Tires.....	209
Instructions for Transporters.....	212
Instructions for Transporters.....	212
In Case of Emergency.....	215
Contacting Tesla Roadside Assistance.....	215
Running Out of Range.....	216
Opening the Hood with No Power.....	217
Jump Starting.....	218
Opening Doors with No Power.....	219
Submerged Vehicle Guidance.....	220
Troubleshooting.....	221
Troubleshooting Alerts.....	221
Consumer Information.....	267
About this Owner Information.....	267
Feature Availability Statement.....	269
Disclaimers.....	270
Reporting Safety Defects.....	271
Certification Conformity.....	272
Index.....	276

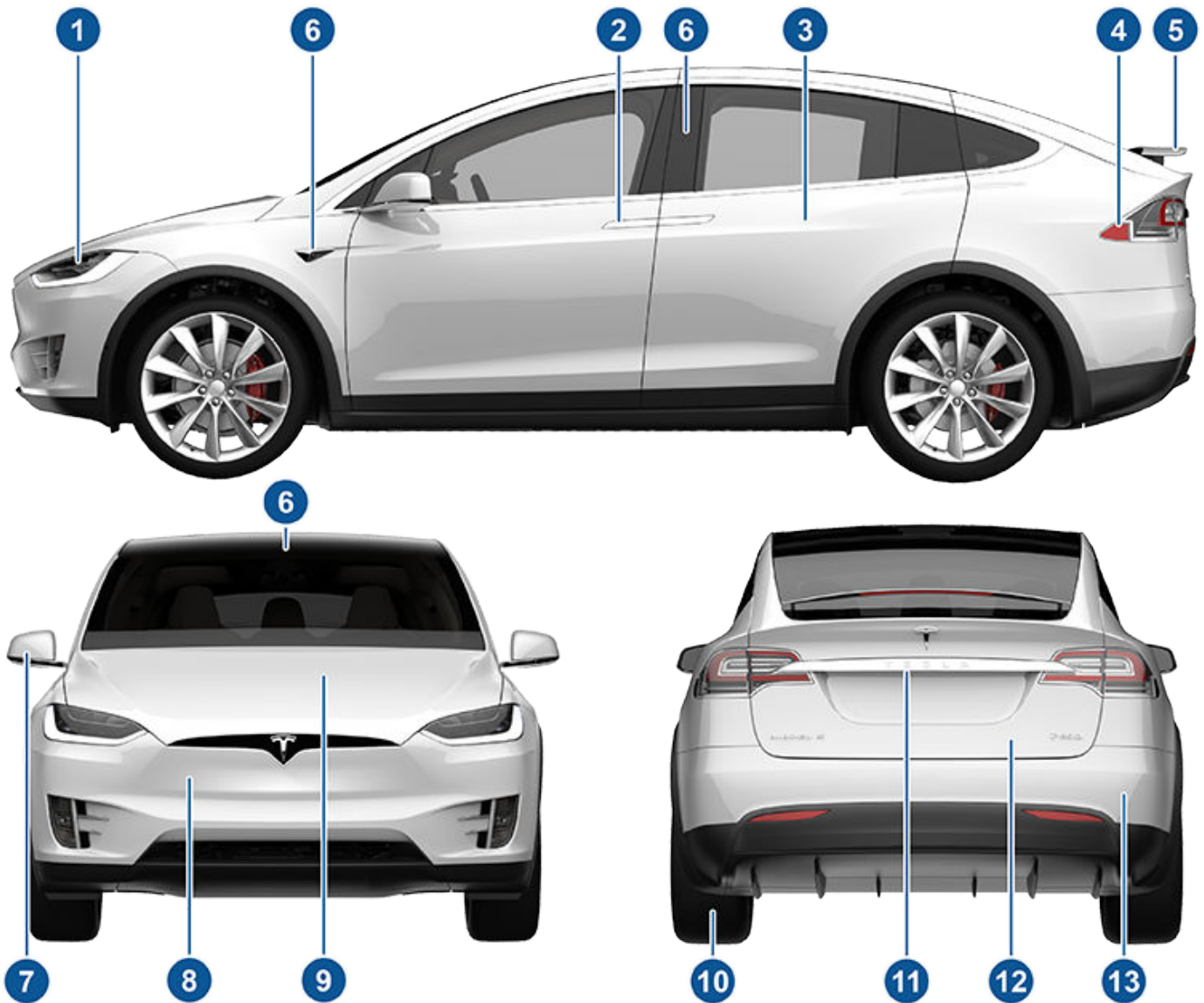

1. Exterior lights ([Lights on page 83](#))
2. Front doors ([Keys and Doors on page 20](#))
3. Falcon wing doors ([Keys and Doors on page 20](#))
4. Charge port ([Charging Instructions on page 172](#))
5. Active spoiler (optional) ([Active Spoiler on page 103](#))
6. Autopilot cameras ([About Autopilot on page 112](#))
7. Exterior mirrors ([Mirrors on page 80](#))
8. Radar sensor (hidden from view in the above image) ([About Autopilot on page 112](#))
9. Hood/Front trunk ([Front Trunk on page 32](#))
10. Wheels and tires ([Wheels and Tires on page 209](#))
11. Rear view camera ([Rear Facing Camera\(s\) on page 101](#) and [About Autopilot on page 112](#))
12. Rear trunk/liftgate ([Rear Trunk on page 30](#))
13. Ultrasonic sensors ([Park Assist on page 92](#) and [About Autopilot on page 112](#))



Interior

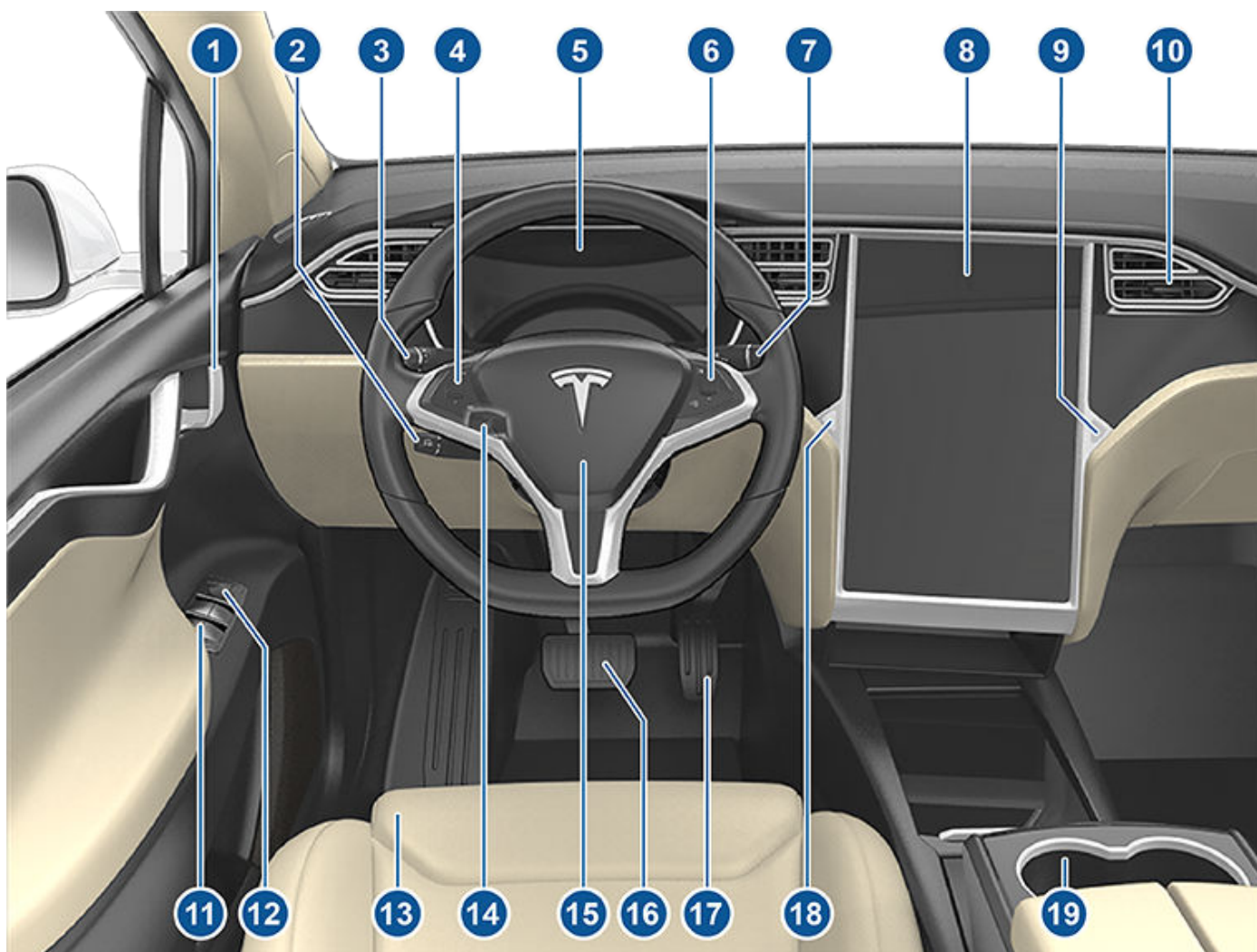

1. Interior door handles ([#unique_17 on page](#))
2. Autopilot stalk ([Traffic-Aware Cruise Control on page 118](#))
3. Turn signal stalk ([High Beam Headlights on page 83](#), [Turn Signals on page 84](#), [Wipers and Washers on page 85](#))
4. Steering wheel buttons - left ([Using Left Steering Wheel Buttons on page 77](#))
5. Instrument panel ([Instrument Panel on page 11](#))
6. Steering wheel buttons - right ([Using Right Steering Wheel Buttons on page 78](#))
7. Drive stalk ([How to Shift on page 82](#))
8. Touchscreen ([Touchscreen on page 6](#))
9. Glovebox button ([Glovebox on page 34](#))
10. Cabin climate control vents ([Operating Climate Controls on page 149](#))
11. Power window switches ([Opening and Closing on page 28](#))
12. Exterior mirror adjustment switches ([Mirrors on page 80](#))
13. Seats ([Front and Rear Seats on page 36](#))
14. Steering column adjuster (hidden from view in the above image) ([Steering Wheel on page 77](#))
15. Horn ([Horn on page 78](#))
16. Brake pedal ([Braking and Stopping on page 86](#))
17. Accelerator pedal ([Acceleration Modes on page 96](#))
18. Hazard warning lights ([Hazard Warning Flashers on page 84](#))
19. Center console

19. Cup holders ([Cup Holders on page 35](#))



Touchscreen

WARNING: Always pay attention to road and traffic conditions when driving. To minimize driver distraction and ensure the safety of vehicle occupants as well as other road users, avoid using the touchscreen to adjust settings while the vehicle is in motion.

Use the touchscreen to control many features that, in traditional cars, are controlled using physical buttons (for example, adjusting the cabin heating and air conditioning, headlights, etc.). You also use the touchscreen to control media, navigate, use entertainment features, and customize Model X to suit your preferences. For hands-free access to common touchscreen controls, use voice commands (see [Voice Commands on page 17](#)).

If the touchscreen is unresponsive or demonstrates unusual behavior, you can restart it (see [Restarting the Touchscreen or Instrument Panel on page 8](#)).

CAUTION: Do not apply a screen protector on the touchscreen. Doing so can result in unintended inputs to the touchscreen (phantom inputs), delayed response or unresponsiveness to touches, electrostatic discharge which can damage the touchscreen, etc. Any damage caused by installing a screen protector is not covered by the warranty.

NOTE: Illustrations are provided to improve conceptual understanding only. Depending on vehicle options, software version, market region and regional and language settings, the details displayed on the screen will differ.

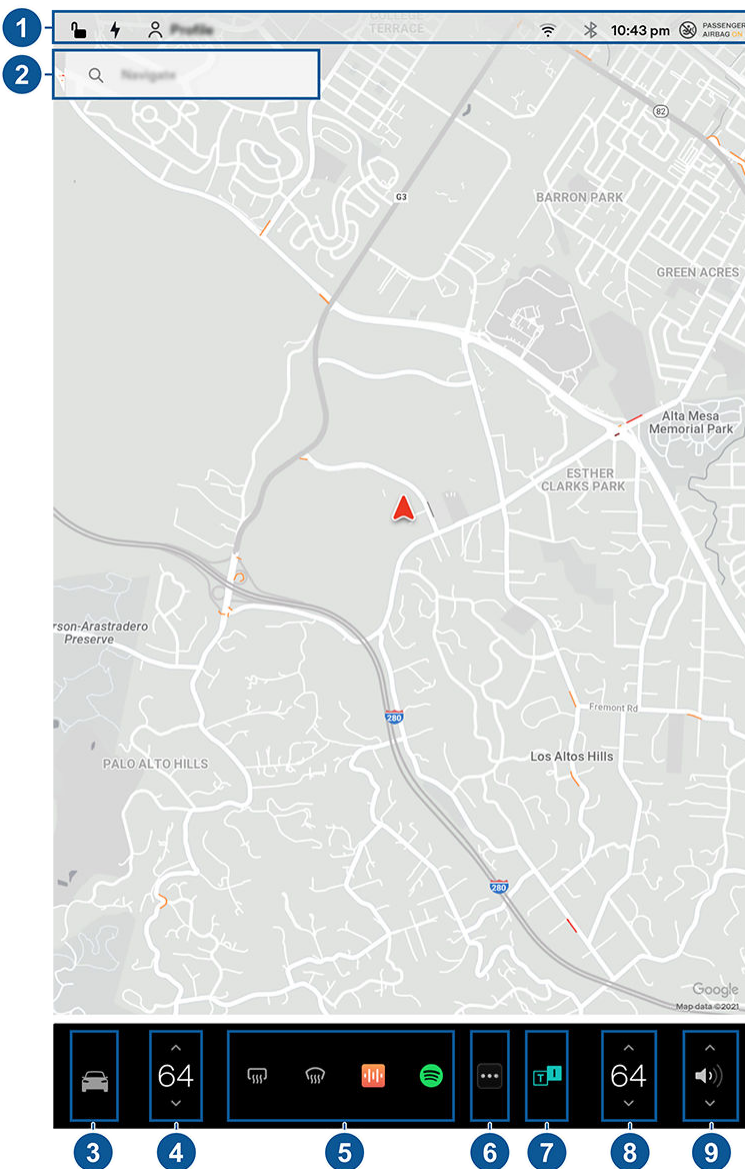

1. **Status bar:** Find car controls and status in the top bar (see [Top Status Bar Icons on page 7](#)).
2. **Navigation:** Change the orientation of the map, find or navigate to a destination, and change navigation settings (see [Maps and Navigation on page 158](#)).

3. **Controls:** Control various features and customize Model X to suit your preferences. The Controls screen appears over the map. Touch an option on the Controls screen to display the various settings and preferences associated with the chosen option.

To search for a specific setting, touch **Search** at the top of the Controls screen. Make changes directly from the result or touch the link to jump to that option in Controls.



When an information icon displays beside a specific setting, touch it to display a popup that provides helpful details about the associated setting.

NOTE: Many vehicle controls, settings, and preferences (such as climate, media, and navigation) can be adjusted hands-free using voice commands (see [Voice Commands on page 17](#)).

NOTE: You can send touchscreen feedback to Tesla by long-pressing this icon.

4. **Climate controls (driver):** Use the left and right arrows to decrease/increase cabin temperature. Touch **Split** on the popup to display separate controls for the driver and passenger. Touch the temperature icon to customize climate control settings (see [Operating Climate Controls on page 149](#)).
5. **My Apps:** For one-touch access to frequently used apps and controls, you can choose what displays here. See [Customizing My Apps on page 7](#).
6. **App Launcher:** Touch the app launcher to open the app tray. Then touch any app to open it. The app you choose displays on top of the map. To close an app, drag it downward.
7. **Recent App(s):** Displays the most recently used app(s). The number of recent apps displayed here depends on how many apps have been added to **My Apps**. If you add the maximum number of apps to **My Apps**, only the most recent app displays.
8. **Climate controls (passenger):** Displays when temperature controls have been **Split** to provide separate controls for the driver and passenger.
9. **Volume Control:** Controls the volume of media player and phone calls (see [Volume Controls on page 163](#)). The volume of navigation instructions is controlled separately (see [Maps and Navigation on page 158](#)).

Customizing My Apps

For one-touch access to commonly used apps and controls, you can customize what displays in the **My Apps** area on the touchscreen's bottom bar:

1. Enter customization mode by touching and holding any app or control in the **My Apps** area. If this area is empty, touch the App Launcher.
2. Drag any app or control from the app tray onto the **My Apps** area in the bottom bar.

NOTE: Seat heaters selected from the app tray appear next to the temperature, instead of in the My Apps area.

NOTE: When you've added the maximum number of apps or controls to **My Apps**, adding an additional app removes the rightmost app.

NOTE: Remove an app or control from the **My Apps** area by touching and holding, then touching its associated "X".

Top Status Bar Icons



Touch to lock/unlock all doors and trunks.

4:20 pm

Your vehicle automatically updates the time. If the time is incorrect, confirm your vehicle has internet and GPS connectivity with the latest software.



Displays when a software update is fully downloaded and ready to install. (See [Software Updates on page 182](#)).



Add, configure, or quickly switch driver profiles (including Valet Mode and Easy Entry). See [Driver Profiles on page 98](#).



Touchscreen



Control or program HomeLink devices (if equipped) (see [Smart Garage on page 73](#)).



Displays when a notification is in effect. Touch to display information about the notification. To display a list of the most recent notifications, with the most recent listed first, you can also touch **Service > Notifications**.



Connected to a Wi-Fi network.



Connected to cellular network. Touch to connect to Wi-Fi (see [Wi-Fi on page 68](#)).



Displays when Model X cellular connectivity is unavailable. Touch this icon for quick access to Wi-Fi settings.



Connect to a Bluetooth device (see [Bluetooth on page 69](#)).



Status of the front passenger airbag (see [Airbags on page 61](#)).

Restarting the Touchscreen or Instrument Panel

You can restart your touchscreen if it is unresponsive or demonstrates unusual behavior.

NOTE: To ensure the safety of occupants as well as other road users, restart the touchscreen only when the vehicle is in Park.

1. Shift into Park.
2. Hold down both scroll buttons on the steering wheel until the touchscreen turns black. Pressing the brake pedal while holding down the scroll buttons does not have any impact and is not required.



3. After a few seconds, the Tesla logo appears. Wait approximately 30 seconds for the touchscreen to restart. If the touchscreen is still unresponsive or demonstrating unusual behavior after a few minutes, try power cycling the vehicle (if possible). See [Power Cycling the Vehicle on page 76](#).

To reset the instrument panel, shift into Park and press the top two buttons on the steering wheel (**Voice Commands** and **Next**) for 15–30 seconds, or until the screen turns black. A few seconds later, a Tesla logo appears. Wait approximately 30 seconds for the instrument panel to restart.

NOTE: Pressing the scroll buttons only restarts the touchscreen. It does not restart any other vehicle component and does not power Model X off and on.

Customizing Display and Sound Settings

Touch **Controls > Display** to adjust display settings to suit your preferences:

- **Appearance:** Customize the display to be **Dark** or **Light**. When set to **Auto**, the brightness changes automatically based on ambient lighting conditions.
- **Brightness:** Drag the slider to manually control the brightness level. If **Display Mode** is set to **Auto**, the touchscreen further adjusts based on both the ambient lighting conditions and your brightness preference. Model X remembers your chosen brightness preference and adjusts the touchscreen accordingly.
- **Energy Saving:** When toggled on, Model X reduces the amount of energy being consumed when not in use (for newer vehicles, this is automated). See [Getting Maximum Range on page 180](#).
- **Screen Clean Mode:** When enabled, your touchscreen darkens and temporarily disables to facilitate cleaning. Follow the onscreen instructions to exit Screen Clean Mode.
- **Touchscreen Language:** Select the language that the touchscreen displays.

NOTE: Model X must be in Park to change the language. When you change the language, you experience a brief delay as Model X shuts down and restarts the touchscreen.

- **Voice Recognition Language:** Choose the language to be used for voice commands.
- **Voice Navigation Language:** Choose the language that the navigation system uses for spoken instructions.
NOTE: For languages that require a download, select the language in the dropdown list to initiate the download (Wi-Fi connection required).
- **Time:** Choose to display time in either 12 or 24 hour format.
- **Region Format:** Choose a region to define the formatting convention used to display dates (mm dd yy/dd-mm-yy, etc.) and decimal separators (5.123, 5,123, etc.).
- **Energy Display:** Choose to display remaining energy and charging units as either a percentage of battery energy remaining, or as an estimate of the distance you can drive.
NOTE: When anticipating when you need to charge, use energy estimate as a general guideline only. Many factors have an impact on energy consumption. See [Factors Affecting Energy Consumption on page 180](#).
- **Distance:** Choose to display measurements in metric (kilometers, centimeters, etc.) or imperial (miles, inches, etc.) units.
- **Temperature:** Choose to display temperature using Fahrenheit or Celsius.
- **Tire Pressure:** Choose to display tire pressures using BAR or PSI.

In addition to customizing the display, you can enable Joe Mode to reduce the volume of all chimes that are not related to critical safety issues. Touch **Controls > Safety > Joe Mode** to enable.

Naming your Vehicle

To further personalize your vehicle, you can name it. Touch **Controls > Software > Name Your Vehicle** located on the right side of the touchscreen below the image of Model X. If your vehicle already has a name, touch the existing name to change it. Enter the new name in the popup and touch **Save**. The name of your Model X also appears in the Tesla mobile app.

Erasing Personal Data with a Factory Reset

When transferring ownership of Model X, perform a factory reset for security purposes *before removing your vehicle from your account* by touching **Controls > Service > Factory Reset**. Before erasing data, Model X verifies your credentials by prompting you to enter the user name and password associated with your Tesla account.

NOTE: Performing a factory reset is only possible when the vehicle is in your account. After the vehicle is removed from your account, you no longer have access to perform a reset of customized settings to the factory defaults and to erase all personal data.



Interior Electronics

In addition to storage compartments and cup holders (see [Interior Storage on page 34](#)), the Model X interior supports various electronics such as USB ports, , and a low voltage power socket.

USB Ports

Your Model X has two USB ports located on the front of the center console that you can use to connect USB devices. To play audio files stored on a USB drive connected to these ports, see [Playing Media from Devices on page 164](#). You can also use these ports to charge USB devices.

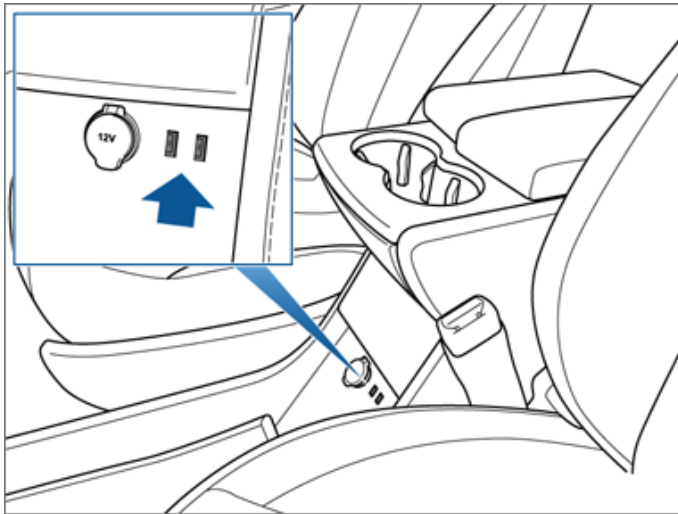

In addition, Model X has two charge-only USB ports located at the rear of the center console, and another charge-only connection located between the third row seats (if equipped).

NOTE: You can charge four devices simultaneously using the two ports at the front of the center console and the two at the rear of the console.

NOTE: Power is available whenever the vehicle is considered "awake" The vehicle may be awake for many reasons. For example, when using features such as Summon, or when features such as Preconditioning, Cabin Overheat Protection, Keep Climate On, Dog Mode, Camp Mode, Sentry Mode, etc. are enabled. The vehicle is also awake whenever the low voltage battery is being charged or is in use, during HV charging, when the vehicle is communicating with the mobile app, etc. Leaving an accessory plugged in does not deplete the low voltage battery.

Low Voltage Power Socket

Your Model X has a power socket located on the front of the center console. An additional low voltage power socket is located in the rear trunk. Power is available whenever the instrument panel and touchscreen are on.

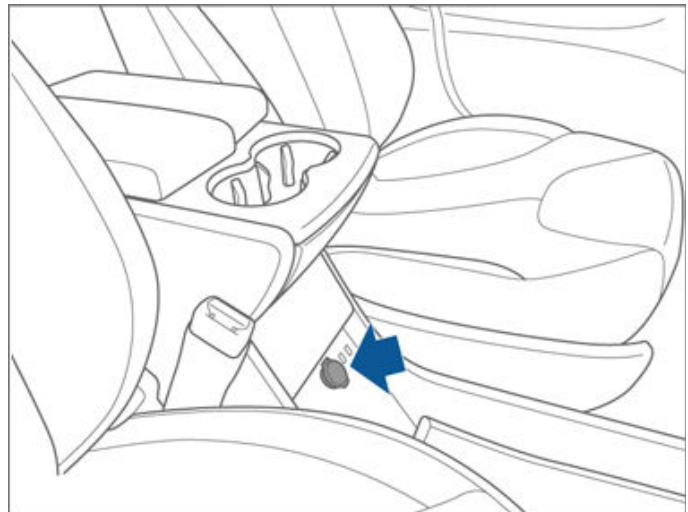

The low voltage power sockets are suitable for accessories requiring up to 11A continuous draw (15A peak) or a maximum of 150 continuous watts (180 watts peak).

NOTE: Power is available whenever the vehicle is considered "awake" The vehicle may be awake for many reasons. For example, when using features such as Summon, or when features such as Preconditioning, Cabin Overheat Protection, Keep Climate On, Dog Mode, Camp Mode, Sentry Mode, etc. are enabled. The vehicle is also awake whenever the low voltage battery is being charged or is in use, during HV charging, when the vehicle is communicating with the mobile app, etc. Leaving an accessory plugged in does not deplete the low voltage battery.

NOTE: In situations where Model X is unable to detect the key fob (low battery, interference, etc.), place it immediately below the low voltage power socket in the center console where Model X can best detect it.



WARNING: The power socket and an accessory's connector can become hot.



Instrument Panel Overview

The instrument panel changes depending on whether Model X is:

- Off (shown below).
- Driving (see [Instrument Panel - Driving](#) on page 15).
- Charging (see [Charging Status](#) on page 173).

When Model X is off, the instrument panel shows remaining estimated range, status of doors, and outside temperature. When you press the brake, indicator lights flash on briefly along the top. Unless an indicator light applies to a current situation, it should turn off. If an indicator light fails to turn on or off, contact Tesla.

NOTE: The following illustration is provided for demonstration purposes only. Depending on vehicle options, software version, and market region, the information displayed may be slightly different.



The following indicators illuminate on the instrument panel to advise you or alert you of a specific condition.



If the touchscreen displays this red brake indicator at any time other than briefly when you first start Model X, a brake system fault is detected, or the level of the brake fluid is low. Contact Tesla immediately. Apply steady pressure and keep the brake pedal firmly pressed to stop the vehicle when safe to do so.



The touchscreen displays this amber brake indicator if a brake booster fault is detected. Apply steady pressure and keep the brake pedal firmly pressed to stop the vehicle when safe to do so. Hydraulic Boost Compensation will be active (see [#unique_63](#) on page).



The ABS indicator briefly flashes amber on the touchscreen when you first start Model X. If this indicator lights up at any other time, an ABS fault has occurred and the ABS is not operating. Contact Tesla. The braking system remains fully operational and is not affected by an ABS failure. However, braking distances may increase. Drive cautiously and avoid heavy braking.



When you manually apply the parking brake using the touchscreen, the red parking brake indicator lights up on the touchscreen.



Instrument Panel



If the parking brake experiences an electrical issue, the amber parking brake indicator lights up and a fault message displays on the touchscreen.



Low beam headlights are on.



High beam headlights are on. Illuminates when high beams are on but the Auto High Beam setting if equipped is turned off or if the Auto High Beam setting is turned on but is temporarily unavailable. See [High Beam Headlights on page 83](#).



High beam headlights are currently turned on, and Auto High Beam if equipped is ready to turn off the high beams if light is detected in front of Model X. See [High Beam Headlights on page 83](#).



High beam headlights are temporarily turned off because Auto High Beam if equipped is on and is detecting light in front of Model X. When light is no longer detected, the high beams automatically turn back on. See [High Beam Headlights on page 83](#).



Parking lights (side marker lights, tail lights, and license plate lights) are on. See [Lights on page 83](#).



Front fog lights, if equipped. See [Lights on page 83](#).



Adaptive Front Lighting, if equipped. See [#unique_64 on page](#) .



Electronic stability control systems are actively minimizing wheel spin by controlling brake pressure and motor power (indicator flashes amber). See [Traction Control on page 95](#). If this indicator remains on, a fault is detected and you should immediately contact Tesla.



If a fault is detected that reduces the performance of the air suspension system, this amber indicator light displays (see [Air Suspension on page 90](#)). If the problem persists, contact Tesla.



If a fault is detected that disables the air suspension system, a red indicator lights up on the instrument panel (see [Air Suspension on page 90](#)). Contact Tesla.



Airbag safety. If this red indicator does not flash on briefly when Model X prepares to drive, or if it remains on, contact Tesla immediately. See [Airbags on page 61](#).



Vehicle Hold is actively applying the brakes. See [Vehicle Hold on page 94](#).



Tire pressure warning. The pressure of a tire is out of range. If a fault with the Tire Pressure Monitoring System (TPMS) is detected, the indicator flashes. For a TPMS fault, contact Tesla. See [Tire Care and Maintenance on page 185](#).



A door or trunk is open. See [Keys and Doors on page 20](#), [Rear Trunk on page 30](#), or [Front Trunk on page 32](#).



A seat belt for an occupied seat is not fastened. See [Seat Belts on page 41](#).



The front passenger's air bag is turned off. See [Airbags on page 61](#).



Electronic stability control systems are no longer minimizing wheel spin. On a Rear Wheel Drive vehicle, the traction control system has been turned off, or on an All-Wheel Drive vehicle, Slip Start has been enabled. See [Traction Control on page 95](#).



Model X is in Transport mode and can roll freely. It does not automatically shift into Park when you exit. See [Instructions for Transporters on page 212](#).



Trailer mode (if equipped) is active. See [Towing and Accessories on page 104](#).



Appears when some of the energy stored in the Battery may not be available due to cold weather conditions. During these cold weather conditions, charging rates may also be limited. If Model X is plugged in, you can heat your Battery by turning on climate control with the mobile app. The snowflake icon disappears when the Battery is sufficiently warm.



Vehicle power is currently being limited because the energy remaining in the Battery is low or the vehicle's systems are being heated or cooled.



Instrument Panel



Flashes green when the left turn signal is operating. Both turn signal indicators flash green when the hazard warning flashers are operating.



Flashes green when the right turn signal is operating. Both turn signal indicators flash green when the hazard warning flashers are operating.

Popup Messages and Vehicle Alerts

Popup messages appear on the instrument panel. For example, a seat belt reminder appears if a seat belt is unfastened in an occupied seat, an alert appears to notify you of an incoming phone call, a text message appears (when applicable), and voice commands appear when in use.

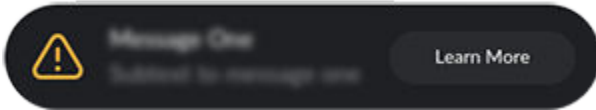

You can view a list of vehicle alerts and notifications by touching the notifications icon on the touchscreen.

NOTE: Not all alerts provide additional information at this time.



Instrument Panel - Driving

When Model X is driving (or ready to drive), the instrument panel shows your current driving status and a real-time visualization of the road as detected by the Autopilot components (see [About Autopilot on page 112](#)). The visualization automatically zooms in and out as needed to inform you when a vehicle is detected in your blind spot.

NOTE: The following illustration is provided for demonstration purposes only. Depending on vehicle options, software version, and market region, the information displayed may be slightly different.

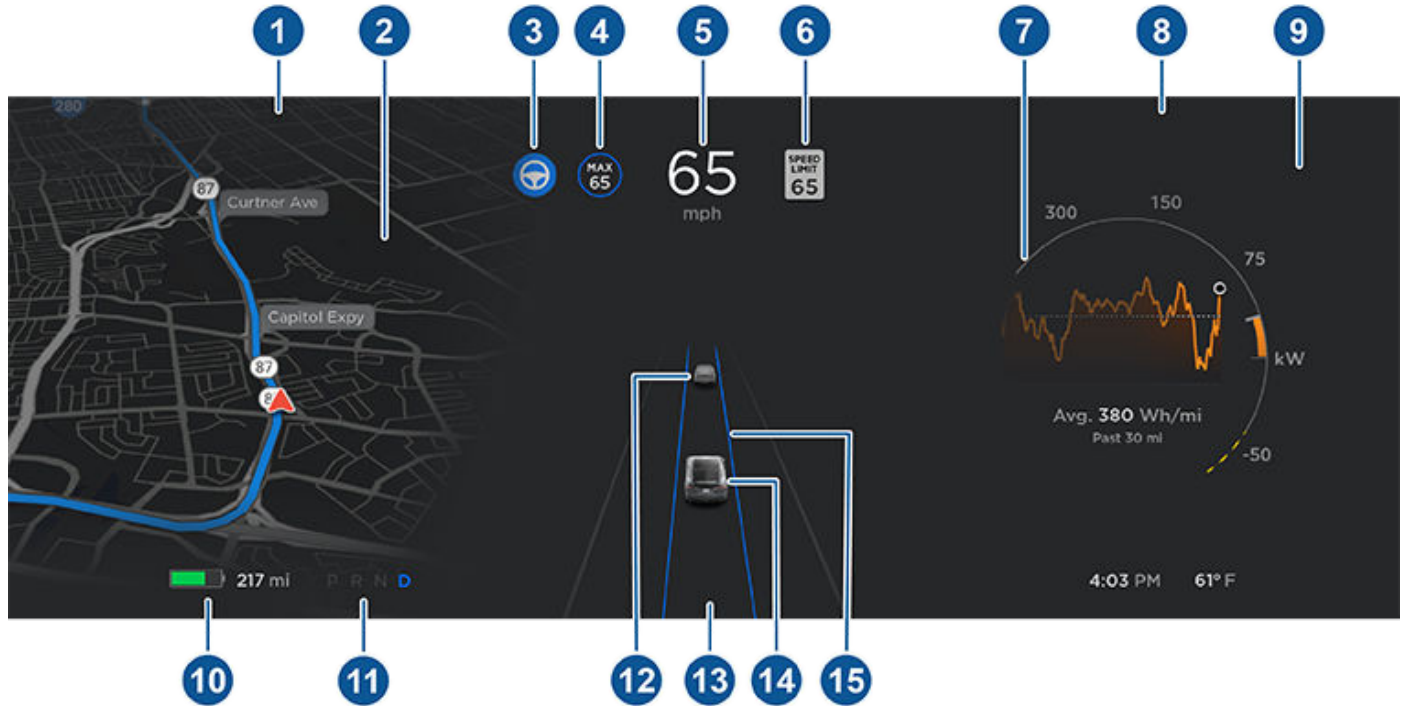

NOTE: Touch **Controls** > **Autopilot** > **Full Self-Driving Visualization Preview** (if equipped) to display more details about the roadway and its surroundings, such as road markings, stop lights, objects (such as trash cans and poles), etc.

- Indicator lights display along the top to provide status (see [Instrument Panel Overview on page 11](#)).
- When you are actively navigating to a destination, navigation instructions display here. Use the left steering wheel buttons to change what displays on the left side of the instrument panel whenever navigation instructions are not displayed (see [Using Left Steering Wheel Buttons on page 77](#)).
- Autosteer is actively steering Model X. When Autosteer is available but you haven't activated it, the icon is gray (see [#unique_73 on page](#)).
- Traffic-Aware Cruise Control is cruising at a set speed. When Traffic-Aware Cruise Control is available but you haven't set a cruising speed, the icon is gray and the speed is not shown (see [Traffic-Aware Cruise Control on page 118](#)).
- Driving speed.
- The speed limit (if available) that is currently being detected by Speed Assist (see [Speed Assist on page 141](#)).

NOTE: The icon associated with the detected speed limit reflects the style of speed limit signs used in your market region.

NOTE: A blue outline may appear around the speed limit icon to notify that you are above the speed limit.

- On the Energy graph, dashed lines appear on the power meter if Model X is limiting power. The dashed lines appear on the top portion (energy being used) when power available for acceleration is being limited, and on the bottom portion (energy being gained) when power that can be gained by regenerative braking is limited. Model X limits power for many reasons. Here are just a few examples:
 - Acceleration may be limited when the Battery is reaching a low state of charge or if the powertrain is hot.
 - Both acceleration and regenerative braking may be limited when the ambient temperature is either very high or very low.
 - Regenerative braking may be limited when the Battery is fully charged.



Instrument Panel

NOTE: Use the right steering wheel buttons to control what displays on the right side of the instrument panel (see [Using Right Steering Wheel Buttons on page 78](#)).

8. Pay attention to important alert messages that display here. If any alerts are in effect, you can view information about them by touching the alert icon (exclamation mark) on the touchscreen's status bar (the topmost area of the touchscreen).
9. Use the right steering wheel buttons to change what displays on the right side of the instrument panel whenever a phone call is not active (see [Using Right Steering Wheel Buttons on page 78](#)).
10. Total estimated driving distance (or energy) available. Instead of driving distance, you can display the percentage of battery energy remaining. To do so, touch **Controls > Display > Energy Display**.

NOTE: When anticipating when you need to charge, use range estimates as a general guideline only.

11. Currently selected drive mode: Park, Reverse, Neutral, or Drive.
12. The car in front of you (if applicable).
13. Pay attention to important driving-related messages that appear at the bottom center of the instrument panel.
14. Your Model X.
15. When Autosteer is active and detects the driving lane, it is highlighted in blue (see [#unique_73 on page](#)). Depending on the current driving scenario, you may see neighboring lanes.

 **WARNING:** Although the instrument panel shows surrounding traffic, some vehicles may not be displayed. Never rely on the instrument panel to determine if a vehicle is present (for example, in your blind spot). Always use your mirrors and perform shoulder checks.



NOTE: For your convenience, Tesla allows you to choose from a variety of languages to use for voice commands. To choose a different language, touch **Controls > Display > Voice Recognition Language**.

Use voice commands to easily control settings and preferences without using the touchscreen. Voice commands are designed to understand natural requests. The following is a non-exhaustive list of actions that you can perform with voice commands:

- Adjust climate preferences
- Tweak the windshield wiper speed and frequency
- Control various aspects of your vehicle
- Navigate to a location
- Call a contact
- Interact with apps and settings

To initiate a voice command, touch the voice button on the right side of the steering wheel. When a chime sounds, make your request.



Examples of Voice Commands

Here is a list of example voice commands. This is not an exhaustive list. Tesla is constantly working to improve voice commands.

NOTE: Your vehicle must be in Park to enable some voice commands (such as Sentry Mode, Dog Mode, etc.).

Climate Controls

Adjust your climate preferences:

- "Make it cooler"
- "Make it warmer"

- "Turn on/off the driver's seat heater"
- "Cool down the passenger"
- "Direct airflow to my face"
- "Sync climate"
- "Increase/decrease the fan speed"
- "Turn on/off rear defroster"
- "Set the temperature/fan..."
- "Turn on recirculate"

Windshield Wipers

Update the windshield wiper speed and frequency based on changing road and weather conditions:

- "Speed up the wipers"
- "Increase/decrease windshield wiper speed by..."
- "Turn on/off the wipers"

Vehicle Controls

Modify various controls in your vehicle:

- "Sentry Mode on/off"
- "Keep my car safe"
- "Lock/unlock the doors"
- "Turn on Dog Mode"
- "Fold/unfold the mirrors"
- "Open/close charge port"
- "Start/stop charging"
- "Open service settings"
- "Open the glovebox"

Navigation

Search for or navigate to a location:

- "Where is [location]?"
- "Drive to [location]"
- "Navigate to [location]"
- "Show nearby Superchargers"
- "I'm feeling hungry/lucky" (see [Maps and Navigation on page 158](#)).
- "Stop navigation"
- "Mute voice guidance"

If you have defined a navigation address for your home or work locations, you can use a voice command to navigate there by saying "Navigate home" or "Take me to work".



Contacts

To call or text a contact on your Bluetooth-connected phone (see [Phone, Calendar, and Web Conferencing on page 71](#)), say:

- "Call [contact name/phone number]"
- "Text [contact name/phone number]"

Media

Listen to media and adjust your playback preferences:

- "Listen to [song name]"
- "Lower/raise the volume"
- "Skip to next"
- "Pause/play song"
- "Change the source to [media source]"

To improve voice command recognition accuracy, provide multiple cues in your command, such as artist and song.

Apps and Settings

Easily navigate through your apps and settings:

- "Open [Toybox/browser/theater/phone]"
- "Search for..."
- "The screen is too bright"
- "Show me the Owner's Manual"

You can also file a bug report by saying "Report", "Feedback", or "Bug report".

For more information on voice commands, go to <https://www.tesla.com/support/voice-commands>.

NOTE: To support ongoing quality improvements, Tesla captures and processes voice command transcriptions (such as "set the temperature..."). Audio voice recordings are not collected, and transcriptions are not associated with your Tesla account or with your vehicle's identification number. To further protect your privacy, voice commands containing personal data are not captured (such as "Navigate to..." or "Make a call to...").

Your Model X includes the following components that actively monitor the surrounding area:

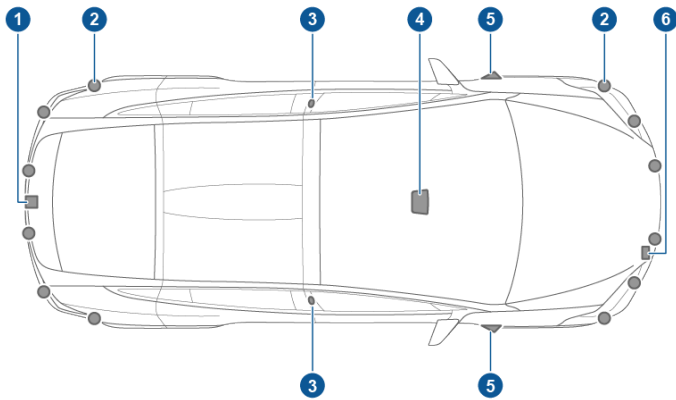

1. A camera is mounted above the rear license plate.
2. Ultrasonic sensors (if equipped) are located in the front and rear bumpers.
3. A camera is mounted in each door pillar.
4. Three cameras are mounted to the windshield above the rear view mirror.
5. A camera is mounted to each front fender.
6. Radar (if equipped) is mounted behind the front bumper.

Model X is also equipped with high precision electronically-assisted braking and steering systems.

Drive to Calibrate Cameras

Model X must maneuver with precision when Autopilot features are being used. Therefore, before some features such as Lane Departure Avoidance and Automatic Emergency Braking can be used for the first time or after some types of service repairs, cameras must complete a self-calibration process. For your convenience, the instrument panel displays a progress indicator.

When calibration is complete, Autopilot features, as well as Active Safety features, are available for use. Calibration typically completes after driving 32-40 km, but the distance varies depending on road and environmental conditions. For example, calibration completes quicker when driving on a straight road with multiple lanes (such as a controlled-access highway), with highly-visible lane markings (in the driving lane as well as the adjacent lanes). Contact Tesla only if your Model X has not completed the calibration process after driving 160 km in the described conditions.

If a camera has shifted from its calibrated position (for example, the camera or windshield was replaced), you must clear the calibration. To do so, touch **Controls** > **Service** > **Camera Calibration** > **Clear Calibration**. When the calibration is cleared, Model X repeats the calibration process. While this helps re-calibrate the cameras in many cases, **Clear Calibration** may not resolve all camera and sensor concerns.

NOTE: The self-calibration drive process is only applicable to Model X vehicles built after approximately October 12, 2016.

NOTE: To calibrate, cameras require highly-visible lane markings in both the driving lane and adjacent lanes (at least two lanes over on each side of the vehicle). For best results, drive in the middle lane of a multi-lane highway (ideally with at least five lanes) that has clear lane markings and minimal traffic.

NOTE: If you attempt to use a feature that is not available until the calibration process is complete, the feature is disabled and the instrument panel displays a message.

NOTE: Model X must repeat the calibration process if the cameras are serviced by Tesla, and in some cases, after a software update.

Keeping Cameras Free of Obstructions

Ensure all cameras are clean and free of obstructions before each drive and before using Autopilot features (see [Cleaning a Camera on page 191](#)). Dirty cameras and sensors (if equipped), as well as environmental conditions such as rain and faded lane markings, can affect Autopilot performance. If a camera is obstructed or blinded, Model X displays a message on the instrument cluster and Autopilot features may not be available.

Condensation can form inside the camera enclosures, especially if you park your vehicle outside in cold or wet conditions. The instrument cluster may display an alert stating that a camera is blocked and that some or all Autopilot features may be temporarily restricted until the camera vision is clear. To proactively dry the condensation, precondition the cabin by setting it to a warm temperature, turning the windshield defroster on, and directing the front air vents toward the door pillars (see [Mobile App on page 66](#)).



Keyless Locking and Unlocking

Locking and unlocking Model X is convenient. Although you must be carrying a valid key fob, there is no need to use it. Model X has sensors around the driver's door that can recognize the presence of a key fob within a range of approximately one meter. So, you can keep your key fob in your pocket or purse and Model X detects it as you approach.

When you walk up to Model X carrying your key fob, the doors automatically unlock if Passive Entry is on (**Controls > Safety > Passive Entry**). To open the rear trunk, press the switch located under the powered liftgate's exterior handle.

NOTE: Model X must detect your key fob near the driver's door before the doors or powered liftgate unlock.

NOTE: If Passive Entry is off, you must use the key fob to unlock Model X. See [Using the Key Fob on page 20](#).

If equipped with the premium upgrade package, and the **Automatic Doors** setting is turned on, when you walk up to Model X carrying your key fob, doors automatically unlock and the driver's door partially opens. If not equipped, or if this setting is turned off, doors automatically unlock and a door opens when you press its handle. Selecting **Exclude Automatic Doors Opening at Home** still allows for automatic closing doors at home but disables automatic door opening (set your home address by touching **Navigate > Set Home**).

NOTE: You can choose whether you want all doors, or just the driver's door, to unlock when you approach Model X carrying your key fob (see [Driver Door Unlock Mode on page 26](#)).

When carrying your key fob with you, you can also open the rear trunk without having to use the key fob. Simply press the switch located under the powered liftgate's exterior handle. Driver Door Unlock Mode (see [Driver Door Unlock Mode on page 26](#)) must be off and the vehicle must detect the key fob near the driver's door before opening the rear trunk.

Model X also locks automatically. If you enable **Walk Away Door Lock**, Model X locks when you walk away carrying your key fob with you (see [Walk-Away Door Lock on page 26](#)).

In addition, you can set Model X to sound a soft horn whenever you car locks or unlocks (if equipped). To set up, touch **Controls > Vehicle > Lock Confirmation Sound**.

While sitting inside Model X, you can also lock and unlock the vehicle by touching the icon on the touchscreen's status bar.

Using the Key Fob

To quickly familiarize yourself with the key fob, think of the key fob as a miniature version of Model X, with the Tesla badge representing the front. The key fob has three buttons on the top that feel like softer areas on the surface, and a metal button on each side representing the falcon wing doors.

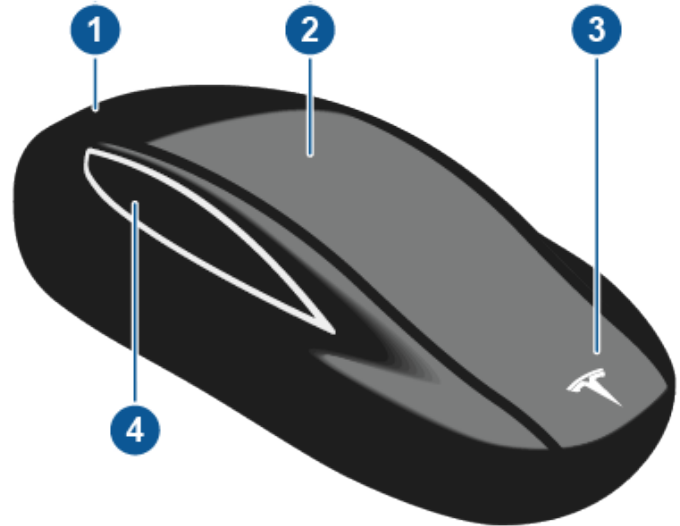

1. Trunk
 - Double-click to open the rear trunk.
 - If equipped with a powered liftgate, double-click to close the rear trunk. You can also single-click to stop the liftgate when it is moving.
 - Hold the button down for one to two seconds to open the charge port door.
2. Lock/Unlock All
 - Single-click to lock all doors and rear trunk. Hazard warning lights flash once.
NOTE: If a door or the rear trunk is open, hazard warning lights flash three times and doors do not lock. But you can enable a single-click to both close all doors (and rear trunk) and lock them, by turning on the **Close All with Key Fob** setting (touch **Controls > Vehicle > Close All with Key Fob**). By default, this setting is turned off and you must triple-click the button to close and lock all doors.
 - Double-click to unlock. Hazard warning lights flash twice.
NOTE: If Model X is equipped with the premium upgrades package and Automatic Doors is enabled (touch **Controls > Vehicle > Automatic Doors**), doors unlock and the driver's door opens as you approach Model X. A subsequent double-click opens the passenger front door.
3. Front trunk
 - Double-click to open the front trunk.
4. Falcon wing doors
 - Double-click to open/close the associated falcon wing door.



- Single-click to stop movement of the associated falcon wing door. Subsequently double-clicking reverses movement of the falcon wing door. For example if the door was opening, it closes, and vice versa.

NOTE: Falcon wing doors are designed to proactively detect obstacles that prevent the doors from moving when an obstacle is detected.

⚠ WARNING: Model X falcon wing doors have several sensors to detect the presence of an object in the door's path. In most cases, when an object is detected, the door stops moving. However, the sensors are unable to detect all areas under all circumstances, particularly when closing. Therefore, you must monitor the movement of falcon wing doors to ensure the door's path of movement is free of obstacles, staying prepared at all times to proactively intervene to stop the door from contacting an object (including a person). Failure to do so can cause serious damage or bodily injury.

You do not need to point the key fob at Model X, but you must be within operating range (which varies depending on the strength of the key fob's battery).

If Model X is unable to detect the key fob, the touchscreen displays a message indicating that a key fob is not inside. Place the key fob where Model X can best detect it, which is below the low voltage power socket (see [Key Fob Not Inside on page 76](#)).

Radio equipment on a similar frequency can affect the key fob. If this happens, move the key fob at least 30 cm away from other electronic devices (phone, laptop, etc). If the key fob does not work, you may need to change its battery. If the key fob's battery is discharged, you can open Model X by following the unlocking procedure (see [Unlocking When the Key Fob Doesn't Work on page 26](#)).

⚠ CAUTION: Remember to bring the key fob with you when you drive. Although you can drive Model X away from its key fob, you will be unable to power it back on after it powers off.

⚠ CAUTION: Protect the key fob from impact, high temperatures, and damage from liquids. Avoid contact with solvents, waxes and abrasive cleaners.

Replacing the Key Fob Battery

The key fob's battery lasts for approximately a year with normal use. When the battery is low, a message displays on the instrument panel. Follow these steps to replace it:

NOTE: Tesla recommends replacing the battery in all key fobs at the same time.

1. With the key fob placed button-side down on a soft surface, use a small flat-bladed tool or fingernail to release the bottom cover.



NOTE: If a lanyard is attached to the key fob, you can release the bottom cover by placing your thumb against the "X" on the bottom cover, then firmly pulling the lanyard toward you (hence pushing the key fob off of its cover). You can also pry the cover off by placing a small flat-bladed tool, a fingernail, or the Tesla-provided tool against the lanyard cord.

2. Remove the battery by carefully releasing it from the retaining clips at an angle.



3. Insert the new battery (type CR2354) with the '+' side facing up. The battery fits snugly so you must slide it into position at an angle toward the Positive contact (the contact located near the center of the key fob), then press down firmly on the other side, ensuring it is held firmly in its intended position.

NOTE: Tesla recommends using Panasonic CR2354 batteries. These can be purchased through online retailers, local supermarkets, and drug stores.

⚠ CAUTION: The battery should press against the spring on the positive contact. Do not place the battery on top of the contact and force it down vertically. Doing so may damage the contact.



Keys and Doors

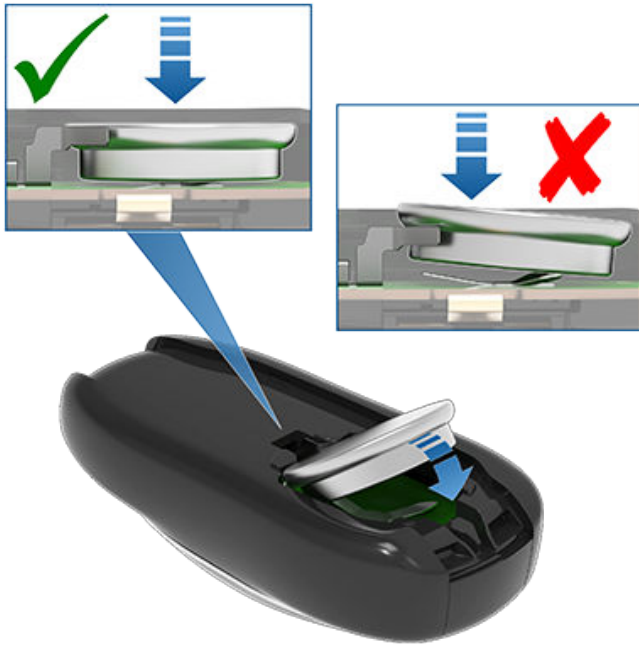

NOTE: Wipe the battery clean before fitting and avoid touching the battery's flat surfaces. Finger marks on the flat surfaces of the battery can reduce battery life.

4. Holding the cover at an angle, align the tabs on the widest side of the cover with the corresponding slots on the key fob, then press the cover firmly onto the key fob until it snaps into place.
5. Test that the key fob works by unlocking and locking your vehicle.

Attaching a Lanyard

The Model X key fob supports the use of a small lanyard. To attach a lanyard, release the bottom cover as described above. Place the lanyard over the pin on the back side of the key fob. Re-align the cover and snap into place.

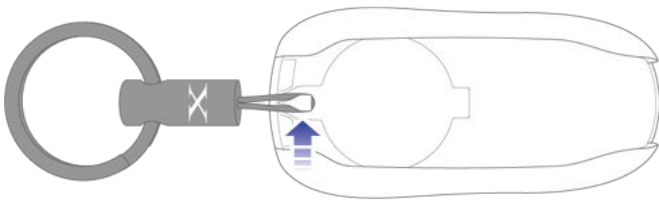

Getting More Key Fobs

If you lose a key fob or require an additional one, contact Tesla. Model X can recognize up to eight key fobs.

When ordering a new key fob for Model X, take all available key fobs with you for reprogramming.

Opening and Closing Front Doors from Interior

To open a front door, pull the interior door handle toward you.



You can also use the touchscreen to open and close doors when inside Model X. Touch **Controls**), then choose the door you want to open or close.

The driver's door automatically closes when you sit in the driver's seat and press the brake pedal. You can also close doors by simply pulling the handle toward you.

WARNING: Before pressing the brake pedal and causing the driver's door to automatically close, ensure that there are no body parts (hands, legs, etc.) obstructing the path of the closing door.

Opening and Closing Front Doors from Outside

Model X doors are electrically powered. When you approach Model X carrying a key, the doors automatically unlock. The front doors open when you press the door handle.

You can also set the driver's door to open automatically upon your approach and close automatically upon your departure (if equipped). The door partially opens between 20° and 45° (halfway open) depending on obstacles detected.

Touch **Controls** > **Vehicle** > **Automatic Doors**. If this setting is on, you can also open the driver's door by double-clicking the key fob's lock/unlock button. A subsequent double-click opens the front passenger door. Selecting **Exclude Automatic Doors Opening at Home** still allows for automatic closing doors at home but disables automatic door opening (set your home address by touching **Navigate** > **Set Home**).

NOTE: Depending on date of manufacture and options chosen at time of purchase, your Model X may not be equipped with automatic doors.



You can also specify that you want to unlock only the driver's door by touching **Controls > Vehicle > Driver Door Unlock Mode**. See [Driver Door Unlock Mode on page 26](#).

NOTE: See [Cold Weather Best Practices on page 155](#) for information on opening the doors in cold weather.

CAUTION: The front doors may not fully open or close automatically when parked on a very steep hill. Never rely on Model X to fully open or close the doors for you when parked on a steep hill.

NOTE: Depending on date of manufacture and options chosen at time of purchase, your Model X may not be equipped with automatic doors.



Whenever a door is open, the Door Open indicator displays on the instrument panel. Also, the image of the Model X on the touchscreen's **Controls** window also provides a visual representation of an open door or trunk.

To close doors from the outside, you can:

- Manually push them shut.
- Single-click or triple-click the key fob's lock/unlock button (if the **Close All with Key Fob** setting is on, only a single click is needed to close all doors and trunks—a triple-click is needed if the setting is off).

NOTE: Powered doors stop moving if an obstacle is detected.

WARNING: Before allowing an automated feature to open or close a front door (rather than doing so manually), it is important to check that the area around the door is free of obstacles (such as people and objects). You must proactively monitor the door's movement to ensure that it does not contact a person or object. Failure to do so can result in damage or serious injury.

Front Door Reset

Since your Model X does not have traditional door handles that you can pull from the outside, it is equipped with pop actuators (sometimes referred to as "ice breakers") that are used to assist in opening the front doors in cases where resistance is detected, such as ice buildup in cold weather. The pop actuator is located just above the front door latch and extends as necessary to open the front door. Once the front door opens slightly, the pop actuator gently retracts back into the door.



If the pop actuator is unable to retract because it is stuck to or caught on something, the pop actuator can be extended manually to extract the object by performing the following:

1. Carefully close the door latch using a pen, screwdriver, or comparable tool (never use a finger or body part and avoid damaging the paint); Model X will detect this as though the door is closed.



2. Make sure Model X is unlocked, then press the exterior door handle or pull the interior door handle to reset the latch and extend the pop actuator.
3. As the pop actuator extends out from the door, quickly extract the object.

WARNING: The pop actuator will attempt to retract back into the door almost immediately after the door handle is pressed or pulled. The pop actuator retracts gently, but will not release automatically if something gets caught.

WARNING: As with all mechanical and moving parts on the vehicle, never put body parts in, or near, moving components. Make sure children are monitored when opening and closing doors. Interacting with moving components, including the pop actuator, can cause serious damage or bodily injury.



Opening and Closing Falcon Wing Doors

Model X has falcon wing doors that easily open and close by pressing a button, using a key fob, or touching the associated icon on the touchscreen. The falcon wing doors are equipped with several sensors that detect the presence of people and objects and, if an object is detected, the door stops moving. Based on detected objects, the doors may adjust their outward and upward movement in an attempt to avoid contacting the object. For example, if an object is detected above Model X, the door's movement may extend further outward but lower, whereas if an object (or person) is detected beside the door, the door may extend outward much less.

⚠ WARNING: It is important to keep your hands clear of the falcon wing door frames at all times. Proactively check the door frame area prior to closing, and monitor the movement of the door during closing to ensure that it does not come into contact with a person or object. Failure to do so can result in damage or serious injury.

⚠ WARNING: Before opening or closing a falcon wing door, it is important to check that the area around the door is free of obstacles (people and objects). Although the doors have many sensors, it can not detect all objects at all times, particularly when moving. At any given moment, there may be areas near the door that are not in the detection zone. Therefore, when opening or closing a falcon wing door, you and your passengers must stand away from the door as it is moving, while proactively monitoring the door's movement and being prepared to take corrective action at any time. To stop a door from moving, single-click the falcon wing door button on the key fob, press the switch on the door or door pillar, or touch the button on the touchscreen.

To open a falcon wing door from outside Model X, press the door handle or double-press the falcon wing door button on the key fob (see [Using the Key Fob on page 20](#)).

To open a falcon wing door from inside Model X, press the switch located on the driver's side door pillar, or, on the touchscreen, touch the associated door icon (**Controls**):

NOTE: Falcon wing doors open only when Model X is stationary.

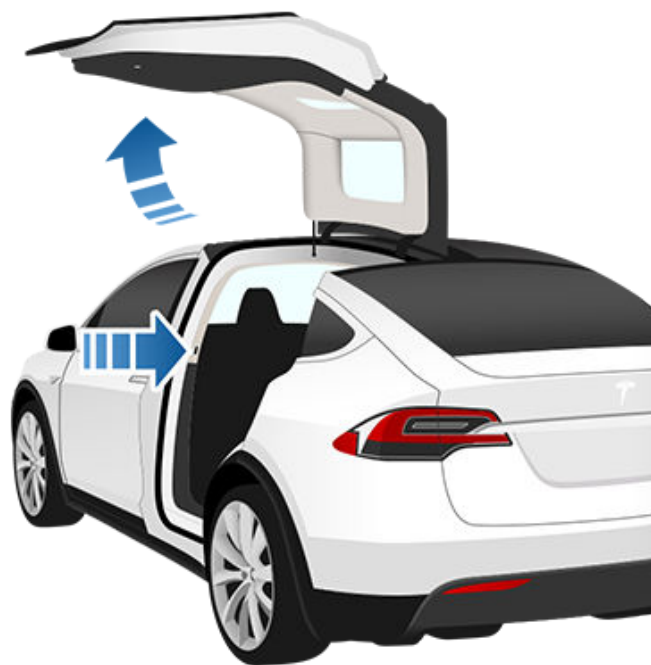

NOTE: If Model X is locked, using the switch (illustrated above) the first time unlocks the associated door. Using it a second time opens it.

⚠ CAUTION: Remove accumulation of snow or ice before opening a falcon wing door. Snow can get inside Model X and ice can prevent the door from opening. In situations where water or snow has accumulated on the glass on top of the falcon wing door, Tesla recommends using the touchscreen or switch on the door pillar (instead of the external door handle or key fob) to slowly open the falcon wing door for the first few inches (cm). Opening the falcon wing door slowly for the first few inches (cm) mitigates the scenario of water, snow, etc. from entering the vehicle.

To close a falcon wing door, press the button located on the inside of the door. You can also use the key fob (see [Using the Key Fob on page 20](#)), use the switch on the door pillar (illustrated above), or touch the associated door icon on the touchscreen (**Controls**).

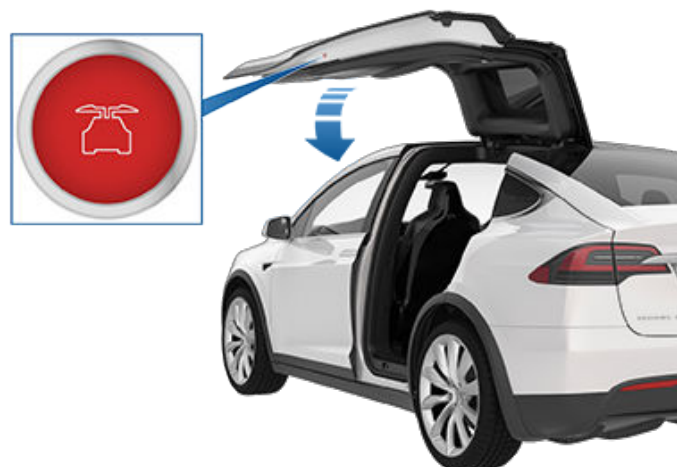



If a falcon wing door is left open when you attempt to shift out of Park, the touchscreen displays a notification requiring you to confirm your intent to drive. The falcon wing door automatically closes when your driving speed reaches 16 km/h. It is your responsibility to ensure doors and trunks are properly closed before driving.

NOTE: To prevent children from opening falcon wing doors using the interior switch, turn on child-protection locks using the touchscreen (**Controls > Vehicle > Child-Protection Lock**). See [Child-Protection Lock on page 26](#).

NOTE: You can configure Model X to open the falcon wing doors to a lower height setting by using the touchscreen (**Controls > Vehicle > Falcon Door Height**).

NOTE: If a falcon wing door detects an obstacle while closing, it reverses a few inches before it stops moving.

⚠ WARNING: Whenever a front door is partially open (approximately 20°) as you are opening or closing the associated falcon wing door, you **MUST** keep your hands (or any object) away from the opening edge of the front door. When a falcon wing door passes by a partially opened front door, the distance between the two doors is very narrow. Objects, such as hands or fingers, placed in this area, are not detected by sensors and can therefore become pinched between the doors. To avoid bodily injury, it is a good practice to keep your hands away from the front door whenever you are opening or closing a falcon wing door.

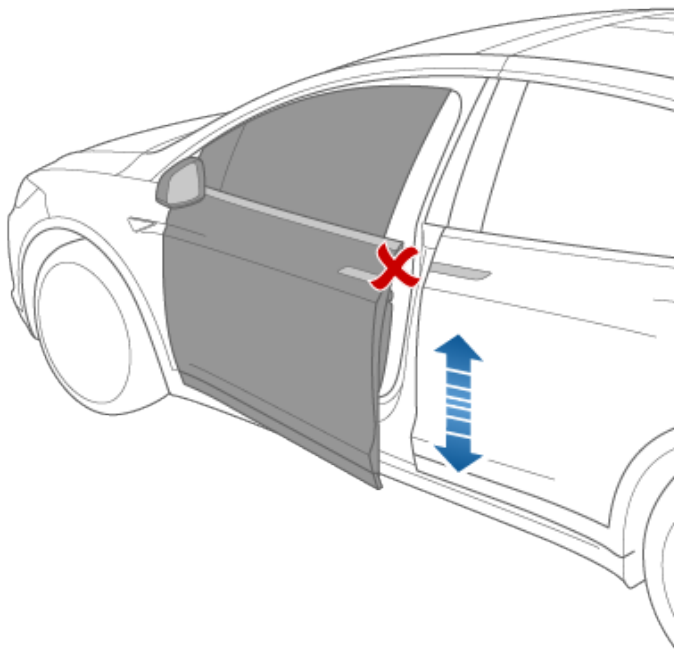

⚠ CAUTION: In rainy weather, leaving a falcon wing open while opening the liftgate can result in rain water falling from the liftgate into the rear seating area.

⚠ WARNING: When opening or closing a falcon wing door, it is important to proactively monitor the movement of the door to ensure that it does not come into contact with a person or object. Failure to do so can cause serious damage or injury.

NOTE: In the unlikely event that Model X has no low voltage power, you will be unable to open the falcon wing doors with the touchscreen or by pressing the switch located on the driver's side door pillar. See [Opening Doors with No Power on page 219](#) for more information.

Obstacle Detection

A falcon wing door stops moving when one of its many sensors detects an obstacle, or when the door senses resistance because it has made contact with an object. The touchscreen displays a warning. In these cases, provided it is appropriate to continue opening or closing the falcon wing door, you can override obstacle detection by pressing and holding the switch located on the door pillar, or touching and holding the associated door icon on the touchscreen.

When Model X detects a low ceiling (for example, in a garage), it opens the falcon wing doors (and trunk) to a lower height, even if no obstacle is detected. You can override this height and open the doors higher by touching the associated door icon on the touchscreen (**Controls**). The touchscreen displays a message asking you if you always want to open the doors to the higher height at this location, and saves your choice. The next time you open the falcon wing doors at this location, Model X opens them to the height you saved.

⚠ WARNING: Before overriding a falcon wing door's default opening height, visually inspect the area to ensure adequate clearance between the door and the detected object.

⚠ WARNING: Applying adhesive products such as wraps, stickers, rubber coating, etc. on the outside of the falcon wing doors can affect the sensors' ability to detect obstacles properly.

Calibration

If the falcon wing doors lose calibration, a message displays on the touchscreen. To calibrate the doors, first ensure that both doors have plenty of space to open and close and are clear of passengers, objects, etc. Then press and hold the **Calibrate** button until calibration is complete. During calibration, the lower door opens all the way out (requiring extra space on the side of Model X), the upper door moves all the way down, and then the lower door closes.

Interior Locking and Unlocking

From inside Model X, you can use the touchscreen to lock or unlock doors and trunks, provided a valid key is inside the vehicle. Touch the lock icon on the touchscreen's status bar.

When you stop Model X and engage Park, you can choose whether you want doors to unlock or remain locked. To do so, touch **Controls > Vehicle > Unlock on Park**. When enabled, doors automatically unlock when you engage Park.

You can also unlock doors by pressing the Park button on the end of the drive stalk a second time (for example, after pressing it one time to engage Park).



Keys and Doors

NOTE: If a door or trunk is still open when you lock Model X, it locks when you close it.

Driver Door Unlock Mode

You can choose to unlock only the driver's door when you approach your vehicle carrying your key fob. To do so, touch **Controls > Vehicle > Driver Door Unlock Mode**. To unlock the remaining doors, use the touchscreen or press the key fob a second time.

Child-Protection Lock

Model X has child-protection locks on the falcon wing doors and liftgate to prevent them from being opened using interior handles. Use the touchscreen to turn child-protection locks on or off. Touch **Controls > Vehicle > Child-Protection Lock**.

NOTE: It is recommended that you turn child-protection locks on whenever children are seated in the rear seats.

Drive Away Locking

Model X automatically locks all doors (including the trunks) whenever your driving speed exceeds 8 km/h.

Walk-Away Door Lock

Doors and trunks automatically lock whenever you walk away carrying the key fob or if the key fob is otherwise not detected by your vehicle (not present, dead battery, etc.).

To turn this feature on or off, touch **Controls > Vehicle > Walk-Away Door Lock**.

NOTE: Touch **Toybox > Boombox > Lock Sound** to customize the lock sound when the vehicle is locked from the outside (Pedestrian Warning System required).

Check the **Exclude Home** checkbox to prevent doors from locking when you walk away carrying the key fob when Model X is parked at the location you have designated as Home. For details on how to designate a location as Home, see [Home, Work, and Favorite Destinations on page 160](#).

If you unlock Model X using the mobile app, it automatically locks after a short period of time if all doors remain closed. If parked in an area without cellular service (such as an indoor parking garage), ensure that you have a functional key fob available to unlock Model X.

If Model X detects an authenticated key fob for five minutes after you exit the vehicle and close all doors, Walk-Away Door Lock disables and doors do not lock when you leave with the key fob. You will need to manually lock Model X until after your next drive.

In addition, if all doors are closed and you use the key fob to unlock Model X, walk away locking is temporarily suspended for one minute. If you open a door within this minute, it does not re-lock until after all the doors are closed and you have walked away with the key fob.

NOTE: It is ultimately your responsibility to ensure your vehicle is locked, even when Walk-Away Door Lock is enabled.

Unlocking When the Key Fob Doesn't Work

If Model X does not unlock when you walk up to it, or when you double-click the unlock button on the top of your key fob, the key fob's battery may be dead. Even if this is the case, you can still use the key fob to unlock and drive Model X.

NOTE: Although you can still use your key fob, you should consider using the mobile app to remotely unlock and start the vehicle. Then, replace your key fob's battery when convenient.

To unlock Model X (and disable the security alarm) using the key fob, first position the key fob at the base of the door pillar between the front door and the falcon wing door, on the driver's side of the vehicle. Then press the driver's door handle. If Model X doesn't unlock, try adjusting the position of the key fob and try again. The key fob must be in the correct position for the vehicle to unlock. If Model X still doesn't unlock, remove the key fob's battery and try again. See [Replacing the Key Fob Battery on page 21](#).

NOTE: The following illustration assumes a left hand drive (LHD) vehicle. On a right hand drive (RHD) vehicle, the locations are mirrored.



To drive Model X after gaining access to the cabin, place the bottom of the key fob against the center console, immediately below the low voltage power outlet, then press and hold the brake pedal to start Model X.

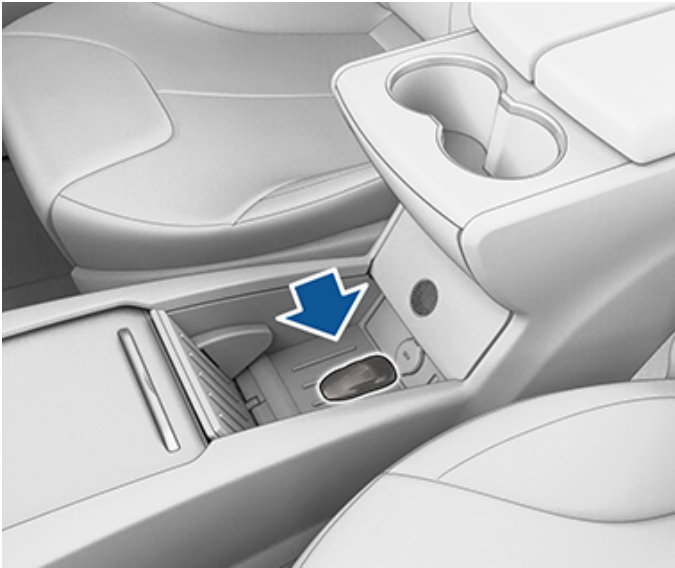

NOTE: Unlocking Model X using this method disables walk away locking. You must manually re-enable walk away locking after replacing the key fob's battery.



Windows

Opening and Closing

NOTE: It is your responsibility to ensure windows are closed after locking the vehicle.

Press down on a switch to lower the associated window. Window switches operate at two levels:

- To lower a window fully, press the switch all the way down and immediately release.
- To lower a window partially, press the switch gently and release when the window is where you want it.

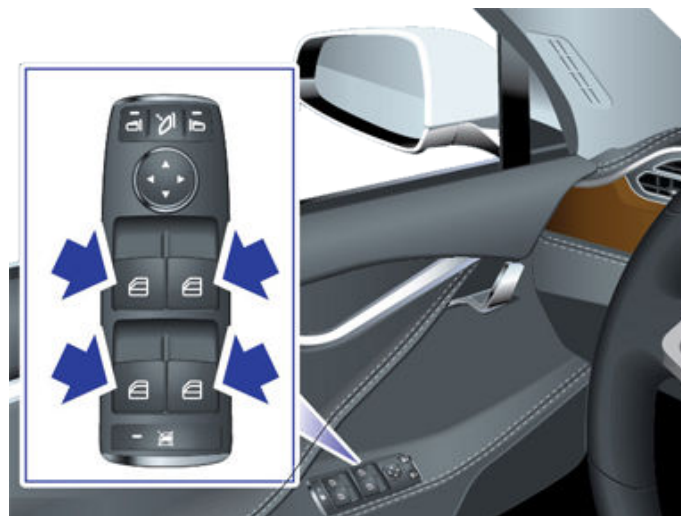

WARNING: To ensure safety, it is recommended that you lock the rear window switches whenever children are seated in the rear seats.

WARNING: Never leave children unattended in Model X.

UV Index Rating

The roof, windshields, and windows in Model X are excellent at protecting you from UV (ultraviolet) rays. The glass components score less than 2 on the UV Index scale. Review your region's UV Index specifications for more information. You are still responsible for taking the necessary precautions for sun protection.

Similarly, pull a switch to raise the associated window:

- To raise a window fully, pull the switch all the way up and immediately release.
- To raise a window partially, pull the switch gently and release when the window is where you want it.

If a window is left open unintentionally, Model X can send a notification to the mobile app (touch **Controls** > **Vehicle** > **Car Left Open Notification**, then choose **Doors & Windows**).

NOTE: See [Cold Weather Best Practices on page 155](#) for information on preparing windows for cold weather.

CAUTION: To avoid damage, windows automatically lower slightly when you open or close a door. If you manually raise a window when the door is open, ensure it is slightly lowered before closing the door.

WARNING: Before closing a window, it is the driver's responsibility to ensure that all occupants, especially children, do not have any body parts extended through the window's opening. Failure to do so can cause serious injury.

Locking Rear Windows

To prevent passengers from using the rear window switches, press the rear window lock switch. The switch light turns on. To unlock rear windows, press the switch again.



The sun visors in Model X are held in place by magnets. To protect occupants from sunlight coming through the windshield, release the sun visor from the pillar and pivot it toward the rear view mirror until the magnet snaps into place. While held in place by the magnet, you can adjust the sun visor and lower the extender to provide maximum shade.

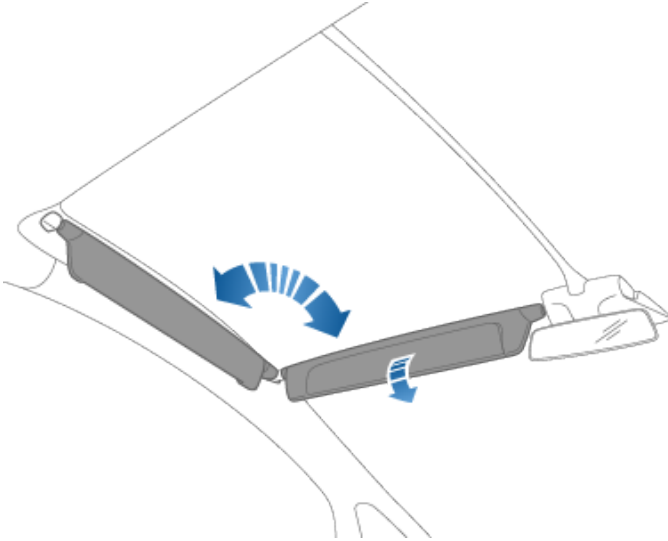

To expose the vanity mirror, lower the visor extender then lower the mirror cover. While the cover is lowered, the mirror is exposed and lights are illuminated.

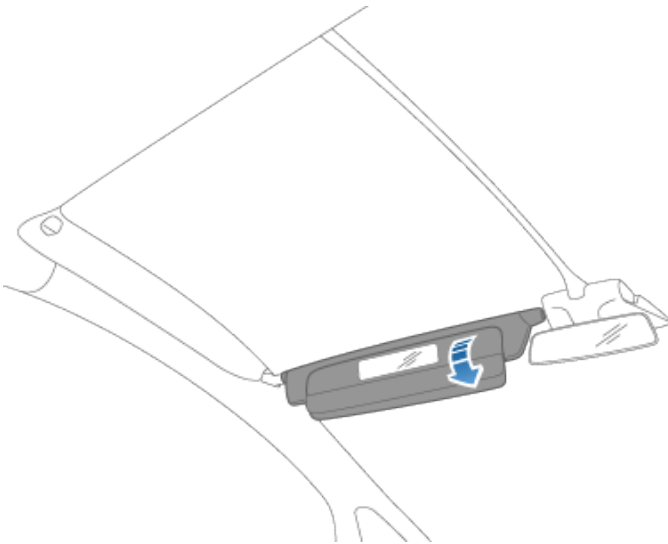

To protect front seat occupants from sunlight coming through the side window, lower the sun visor from the pillar then lower the visor extender.



Rear Trunk

Opening

To open the rear trunk, ensure Model X is in Park, then do one of the following:

- Touch **Controls** > **Trunk** on the touchscreen.
- Double-click the rear trunk button on the key fob.
- Touch the rear trunk button on the mobile app.
- Press the switch located under the liftgate's exterior handle (a valid key must be detected).

NOTE: If **Passive Entry** is off, you must use a key fob to unlock Model X before you can use the switch to open the liftgate. See [Using the Key Fob on page 20](#).

CAUTION: Before opening the liftgate in an enclosed area (such as a garage), ensure the opening height of the liftgate is properly adjusted to avoid low-hanging ceilings or objects (see [Adjusting Liftgate Opening Height on page 30](#)).

Model X must be unlocked or detect a key before you can use the switch to open the liftgate.

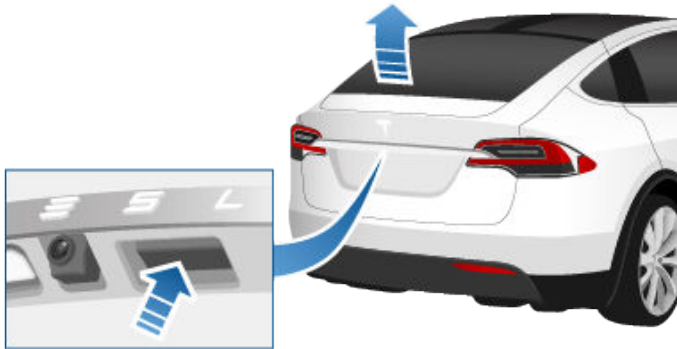

When a door, trunk or liftgate is open, the instrument panel displays the Door Open indicator light. The image of your Model X on the touchscreen also displays the open trunk.

To stop a liftgate while it is moving, single-click the rear trunk button on the key fob. Then, when you double-click the rear trunk button, it moves again, but in the opposite direction (provided it was not almost entirely open or closed when you stopped it). For example, if you single-click to stop the liftgate while opening, when you double-click, it closes.

NOTE: In emergency situations, you can override an open or close command by grasping the liftgate to stop it in place.

To open the liftgate from inside the vehicle in the unlikely situation that Model X has no power, see [Interior Emergency Trunk Release on page 31](#).

If Model X detects a low ceiling (for example, in a garage), it opens the liftgate (and falcon wing doors) to a lower height, even if no obstacle is detected. You can override this height by manually lifting it higher. When doing so, the touchscreen prompts you to choose if you always want the trunk to open to this higher position at this location, and saves your choice. If you choose to do so, the next time you open the liftgate at this location, Model X opens it to the saved height.

WARNING: Before opening or closing the liftgate, check the surrounding area (for people and objects). Although the liftgate can detect obstacles, it cannot detect all objects at all times. Do not rely on the liftgate to sense an obstruction when opening or closing. You must proactively monitor the liftgate to ensure that it does not come into contact with a person or object. Failure to do so may result in damage or injury.

Adjusting Liftgate Opening Height

You can adjust the opening height of the liftgate to make it easier to reach or to avoid low-hanging ceilings or objects (for example, a garage door or light):

1. Open the trunk, then manually lower or raise the liftgate to the desired opening height.
2. Press and hold the button on the underside of the liftgate for three seconds until you hear a confirmation chime.



3. Confirm that you have set it to the desired height by closing the liftgate, then reopening it.

CAUTION: Depending on configuration (such as suspension height or wheel selection), your vehicle's liftgate can open up to approximately 2.5 meters high. Adjust the liftgate height to prevent it from coming into contact with low ceilings or other objects.

Closing

To close the liftgate, do one of the following:

- Touch **Controls** > **Trunk**.
- Double-click the rear trunk button on the key fob.

- Press the switch located on the underside of the liftgate

If the liftgate senses an obstruction when closing, it stops moving and chimes two times. Remove the obstruction and try closing it again.

Accessing the Cargo Area

Secure all cargo before moving Model X, and place heavy cargo in the lower trunk compartment.

To access the cargo area inside the rear trunk, push down on the ridged portion of the handle of the cargo cover and then pull up. You can then adjust the position of the cargo cover or completely remove it.

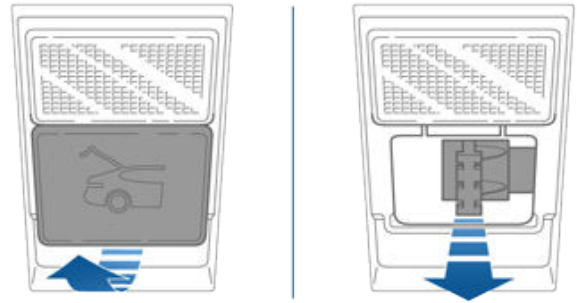

1. Remove the cover by pulling its lower edge very firmly toward you.
2. Pull the cable to release the latch.
3. Push the rear trunk open.

NOTE: The button glows for several hours after a brief exposure to ambient light.

-  **WARNING:** Do not allow children to play inside the trunk or become locked inside. An unrestrained child could suffer serious injury or death in a crash. A child could suffer heat exhaustion or death if trapped in the vehicle, especially without climate control on.

Rear Trunk Load Limits

Distribute the weight of cargo as evenly as possible between the front and rear trunks.

-  **CAUTION:** Never load more than 80 kg in the upper compartment of the rear trunk or more than 285 lbs (130 kg) in the lower compartment. Doing so can cause damage.

-  **WARNING:** When loading cargo, always consider the vehicle's Technically Permissible Maximum Laden Mass (TPMLM) (see [Specifications on page 202](#)). The TPMLM is the maximum allowable total mass of the vehicle including all passengers, fluids, and cargo.

Interior Emergency Trunk Release

An illuminated mechanical release located inside the rear trunk allows you to open the rear trunk from the inside if Model X has no electrical power. This mechanical release also allows a person locked inside to get out.



Front Trunk

Opening

To open the front trunk, ensure Model X is in Park, and then do one of the following before pulling the hood open:

- Touch **Controls** > **Front Trunk** on the touchscreen.
- Double-click the front trunk button on the key fob.
- Touch the front trunk button in the mobile app.



When a door or trunk/liftgate is open, the instrument panel displays the Door Open indicator light. The image of your Model X on the touchscreen also displays the open front trunk.

WARNING: Before opening or closing the hood, it is important to check that the area around the hood is free of obstacles (people and objects). Failure to do so may result in damage or serious injury.

Closing

The Model X hood is not heavy enough to latch under its own weight and applying pressure on the front edge or center of the hood can cause damage.

To properly close the hood:

1. Lower the hood until the striker touches the latches.
2. Place both hands on the front of the hood in the areas shown (in green), then press down firmly to engage the latches.
3. Carefully try to lift the front edge of the hood to ensure that it is fully closed.

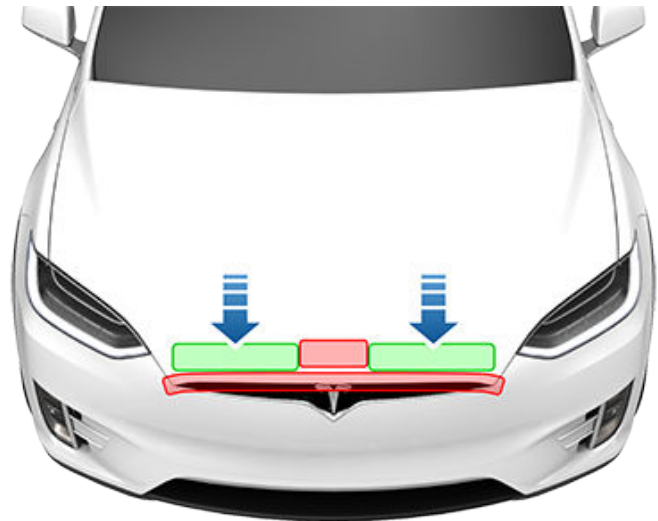

CAUTION: To prevent damage:

- Apply pressure only to the green areas shown. Applying pressure to the red areas can cause damage.
- Do not close the hood with one hand. Doing so applies concentrated force in one area and can result in a dent or crease.
- Do not apply pressure to the front edge of the hood. Doing so can crease the edge.
- Do not slam or drop the hood.
- To avoid scratches, don't have anything in your hands (keys). Jewelry can also cause scratches.

WARNING: Before driving, you must ensure that the hood is securely latched in the fully closed position by carefully trying to lift the front edge of the hood upward and confirming there is no movement. It is the driver's responsibility to ensure that the front trunk is properly closed before driving.

If a falcon wing door or the front trunk is left open when you attempt to shift out of Park, a notification requiring you to confirm your intent to drive appears on the touchscreen. The falcon wing doors may automatically close once you begin to accelerate.

The front trunk locks when:

- You lock Model X using the touchscreen, key or mobile app.
- You leave Model X carrying your key (if [Walk-Away Door Lock](#) on page 26 is turned on).
- Valet mode is active (see [Valet Mode](#) on page 98).

Front Trunk Load Limit

Distribute the weight of cargo as evenly as possible between the front and rear trunks.

- ⚠ CAUTION:** Never load more than 136 kg in the front trunk. Doing so can cause damage.
- ⚠ WARNING:** When loading cargo, always consider the vehicle's Technically Permissible Maximum Laden Mass (TPMLM) (see [Specifications on page 202](#)). The TPMLM is the maximum allowable total mass of the vehicle including all passengers, fluids, and cargo.

Interior Emergency Release

An illuminated interior release button inside the front trunk allows a person locked inside to get out.

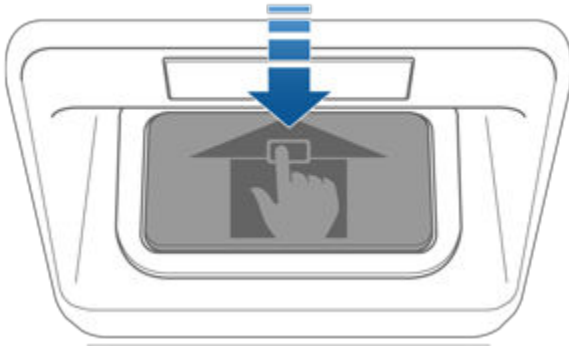

Press the interior release button to unlatch the front trunk, then push up on the hood.

NOTE: The interior release button glows following a brief exposure to ambient light.

- ⚠ WARNING:** People should never climb inside the front trunk. Never shut the front trunk when a person is inside.
- ⚠ WARNING:** Care should be taken to ensure that objects inside the front trunk do not bump against the release button, causing the hood to accidentally open.



Interior Storage

Glovebox

To open the glovebox, press the switch located on the side of the touchscreen. The glovebox locks whenever Model X is locked externally, using the key or walk-away locking. It also locks when Model X is in Valet mode (see [Valet Mode on page 98](#)). It does not lock when you lock Model X using the lock icon on the touchscreen's status bar.

For additional glovebox security, touch **Controls > Safety > Glovebox PIN** to set a 4-digit PIN (see [Glovebox PIN on page 143](#)).

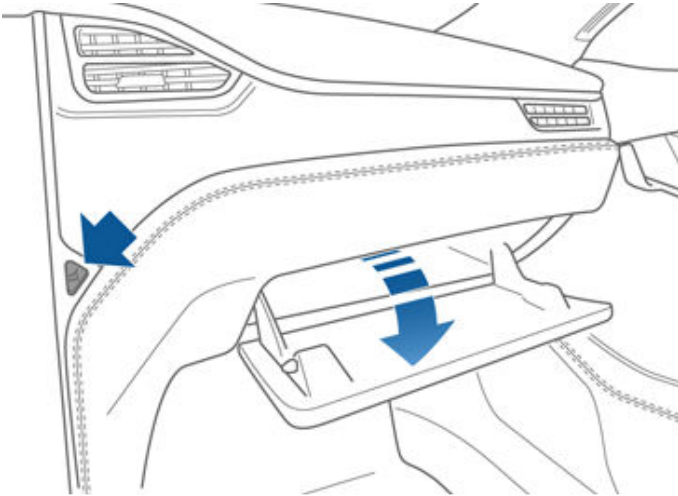

NOTE: If you leave the glovebox open, its light eventually turns off.

⚠ WARNING: When driving, keep the glovebox closed to prevent injury to a passenger if a collision or sudden stop occurs.



Cup Holders

To expose a front cup holder, slide back the armrest.

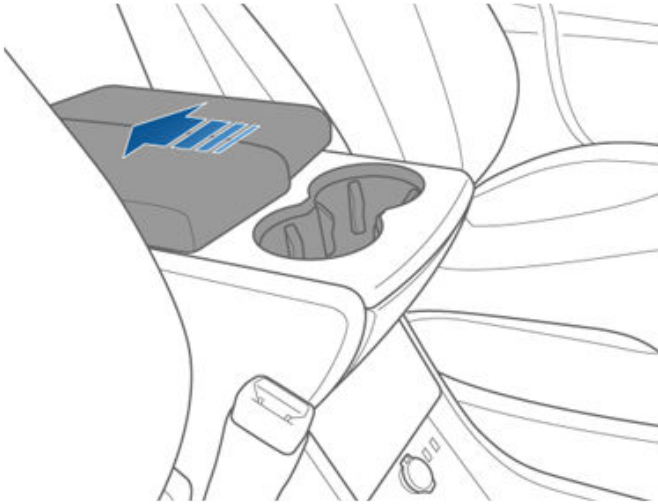

To expose rear cup holders (if equipped), press and release the cup holder face plate located at the back of the center console.

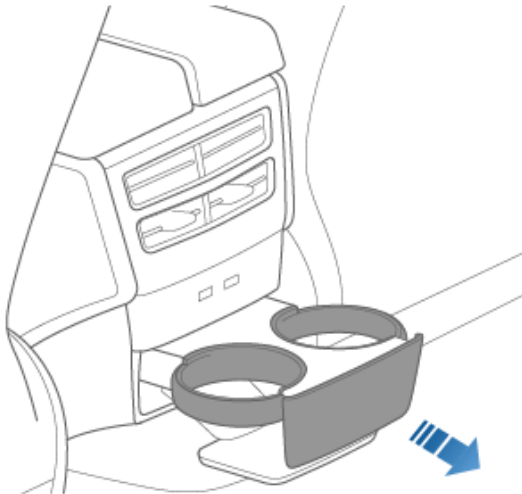



Front and Rear Seats

Adjusting the Driver's Seat

need to ensure this OCS content is removed in non NA owners manuals

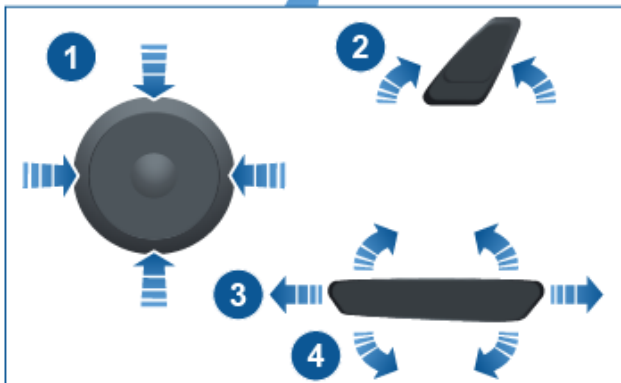
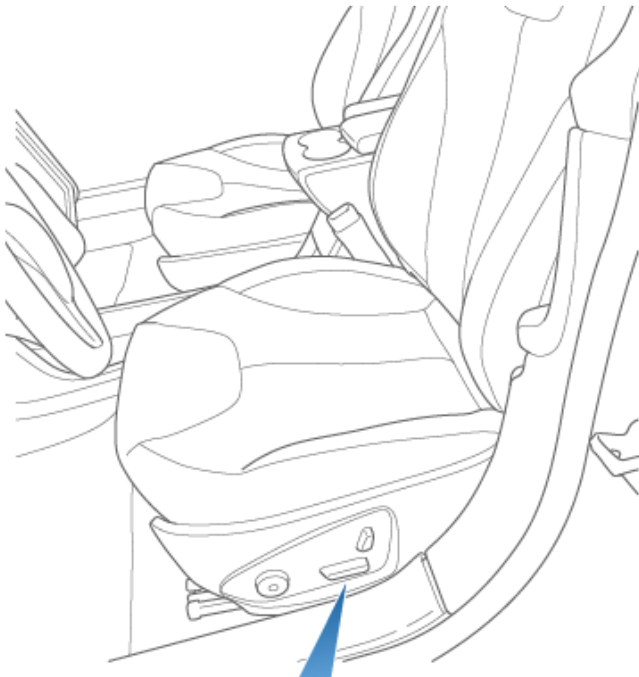

1. Adjust lumbar support.

NOTE: This button is also used to move the head support up or down (see [Head Supports/Restraints](#) on page 40). When you touch this button, the touchscreen displays a popup with an image of the seat. If the lumbar area on the image is not highlighted in blue, touch the lumbar area on the image to specify that you want to adjust lumbar support. The selection you choose is retained until you manually change it.

2. Adjust backrest.
3. Move seat forward/backward.
4. Adjust the seat's height and tilt angle.

⚠ WARNING: Before adjusting a front seat, check that the area around the seat is free of obstacles (people and objects).

⚠ WARNING: Do not adjust seats while driving. Doing so increases the risk of a collision.

⚠ WARNING: Riding in a moving vehicle with the seat back reclined can result in serious injuries in a collision, as you could slide under the lap belt or be propelled into the seat belt. Ensure your seat back is reclined no more than 30 degrees when the vehicle is moving.

Correct Driving Position

The seat, head support, seat belt and airbags work together to maximize your safety. Using these correctly ensures greater protection.



Position the seat so you can wear the seat belt correctly, while being as far away from the front airbag as possible:

1. Sit upright with both feet on the floor and the seat back in an upright position.
2. Make sure you can easily reach the pedals and that your arms are slightly bent when holding the steering wheel. Your chest should be at least 25 cm from the center of the airbag cover.
3. Place the shoulder section of the seat belt mid-way between your neck and your shoulder. Fit the lap section of the belt tightly across your hips, not across your stomach.

Adjusting Second Row Monopost Seats

A Model X equipped with monopost seats can accommodate two or three passengers in the second row, depending on the option chosen at time of purchase. There are two ways to adjust the position of these seats:



- Touch **Controls > Seats** on the touchscreen. Press and hold the icon associated with the seat you want to adjust. White icons indicate that the seat can be moved in that direction; gray icons indicate that the seat cannot be moved any farther in that direction.

NOTE: The front seats may move forward slightly to accommodate the forward movement of the second row seats.

- Use the manual adjustments illustrated below. In addition to moving a seat forward/rearward, the manual seat adjustments allow you to adjust the backrest. Although the control on the outboard seats is L-shaped, and the control on the middle seat is circular, they both provide the same functions.

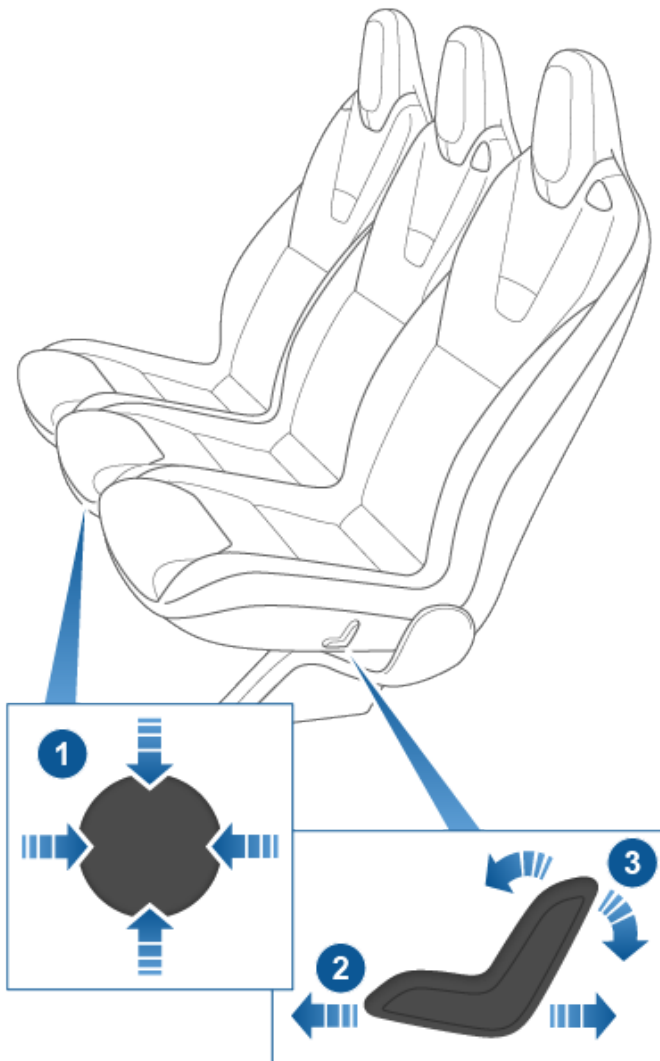

1. Move seat forward/backward (up/down on the control) and adjust the backrest (left/right on the control).
2. Move seat forward/backward.
3. Adjust backrest.

NOTE: The backrest locks into position when you release the lever. If a backrest is not locked into position when a driving gear is engaged, the instrument panel displays an alert for the unlocked backrest. Adjust the backrest again, ensuring it locks into position.

⚠ WARNING: Before driving, ensure the seat is locked in position. You may need to pull the seat forward or backward until it clicks into place.

Adjusting Second Row Seat Backs (Bench Seats)

If your Model X is equipped with two seating rows, the second row bench seats can accommodate up to three passengers. Use the mechanical adjustment lever located at the side of each outboard seating position to adjust the seat backs. A bench seat is split 60/40 so the adjustment lever on the left side moves the seat backs for both the left and center seats, whereas the lever on the right side moves the rightmost seat back only. While pulling and holding the lever, move the seat back to the desired position, and then release the lever. When returning a seat back to its upright position, try moving it forward or back to ensure it is securely latched into position.



⚠ WARNING: Riding in a moving vehicle with the seat back reclined can result in serious injuries in a collision, as you could slide under the lap belt or be propelled into the seat belt. Ensure the backs of occupied seats are reclined no more than 30 degrees when the vehicle is moving.

Folding Second Row Seat Backs (Bench Seats)

The second row seat backs on bench seats can be folded fully forward so they lay flat and maximize cargo space. Pull up the mechanical lever located on the side of each outboard seat (the same lever you use to recline the seats, as described above), then push the seat back fully forward. The bench seats have a 60/40 split—therefore, the adjustment



Front and Rear Seats

lever on the left side folds the seat backs for both the left and center seats, whereas the lever on the right folds the rightmost seat back only.

NOTE: Before folding seats fully forward, remove any items from the seats and the rear footwell. To allow the seat backs to fold completely flat, you may need to move the front seats forward.

CAUTION: Before folding seats all the way down, ensure the seat belt is unbuckled and there are no objects remaining on the seat.

Moving Second Row Bench Seats

NOTE: Only bench seats in seven-seat vehicles can be moved forward and rearward. The bench seats in five-seat vehicles are stationary.

Use the mechanical lever located beneath each outboard seating position to move the second row seats forward or rearward. The bench seats have a 60/40 split—therefore, the lever on the left side moves the seat for the left and center seats, whereas the lever on the right side moves only the rightmost seat. Pull and hold the lever while moving the seat forward or rearward. Release the lever when the seat is at the desired location.



NOTE: You can adjust the position of bench seats using the mechanical levers only. You cannot use the touchscreen to adjust bench seats.

Accessing Third Row Seats (if equipped) - Monopost Seating

A button is located on the backrest of each outboard monopost seat in the second row. This button makes it easy for passengers to enter and exit the third row seating positions. Touch **Controls > Seats > Easy Entry** and choose how you want this button to work:

- **ON** - Allows you to tilt and move the associated outboard seat fully forward, and the center seat partially forward, with a **single-press** of the button.

- **OFF** - When off, which is recommended if a child seat is installed in the second row, you must **hold** the button to move the second row seats forward.

After using the third row ingress button to access third row seats, simply press the button again to return the seats to their normal position.



WARNING: For vehicles with third row seats, do not use the third row ingress button located on the backrest of a second row outboard seat when a child is seated in the second row. Using the button tilts and moves the seats forward and can squeeze the occupant. Do not rely on Model X to recognize or accommodate occupants seated in the vehicle while using this button. Use this button only when the second row seats are unoccupied.

Guidelines for using the third row ingress button:

- If a front row seat is positioned such that the second row seat will collide with it during an easy entry operation, it automatically moves forward just enough to accommodate the forward position of the second row monopost seat.
- Forward movement of second row monopost seats cancels if an occupant adjusts a second row seat while it is moving.
- When an outboard seat tilts forward after pressing the button, its backrest resets to the forward position and may need to be re-adjusted for comfort.



WARNING: Use the third row ingress button to access the third row ONLY when the second row seats are unoccupied. Do not rely on Model X to recognize or accommodate occupants seated in the vehicle while using the button.

WARNING: Always ensure that the seat is locked in position before traveling. Failure to do so increases the risk of injury.

Accessing Third Row Seats (if equipped) - Bench Seating

A button is located on the backrest of each outboard bench seat in the second row. This button makes it easy for passengers to enter and exit the third row seating positions. Press and release the button on the left outboard seat to tilt and move the combined left and center seats forward. Press and release the button on the right outboard seat to tilt and move the right seat forward.



WARNING: For vehicles with third row seats, do not use the third row ingress button located on the backrest of a second row outboard bench seat when a child is seated in the second row. Using the button allows the combined left and center seats to be moved forward and can squeeze the occupant. Use this button only when the second row seats are unoccupied. Before driving, ensure the seat and the seat back are securely latched into position.

In some situations, such as when you are parked on an incline or when the seat's trim affects the movement of the bench seats after you press the button, the bench seats might not move forward completely, and you may need to push the seats forward gently until they reach the end of the track.

WARNING: After you use the third row ingress button to access the third row seats, push the bench seats back to their seating position, ensuring the seats are securely latched into position by trying to move them forward and rearward. Failure to do so increases the risk of injury.

WARNING: The seat must be fully latched into position before driving. Push or pull the seat until you hear the seat "click" into place.

Folding and Raising Third Row Seat Backs (if equipped)

To fold a third row seat, press the button located in the top outside corner of the seat. The button has two detents.



1. Fold head restraint forward.
2. Fold seat back forward.

To raise the seats, hold the button on the top outside corner of the seat then pull the seat back upward until it latches into place. Try pulling the seat back forward to confirm that it is locked in the upright position.

NOTE: Before folding third row seat backs, remove any items from the seats and the footwell. To allow the seat backs to fold completely flat, you may need to move the second row seats forward.

NOTE: Driving with the third row seats backs folded forward might result in increased perceivable noise and/or vibration coming from the rear of the vehicle (trunk, suspension, etc.).

CAUTION: Before folding seats all the way down, ensure the seat belt is unbuckled and there are no objects remaining on the seat.

WARNING: Always ensure the seats and seat backs are locked in their upright position before travel. Failure to do so increases the risk of injury.



Front and Rear Seats

Head Supports/Restraints

Use the round button on the seat to move the head support up/down. The same button is used to adjust the seat's lumbar support (see [Adjusting the Driver's Seat on page 36](#)). Therefore, when you touch this button, the touchscreen displays a popup with an image of the seat. If the head support shown on the image is not highlighted in blue, touch this area on the image to specify that you want to adjust the head support. The selection you choose is saved until you manually change it. You can save the head support setting to your driver profile (see [Driver Profiles on page 98](#)).

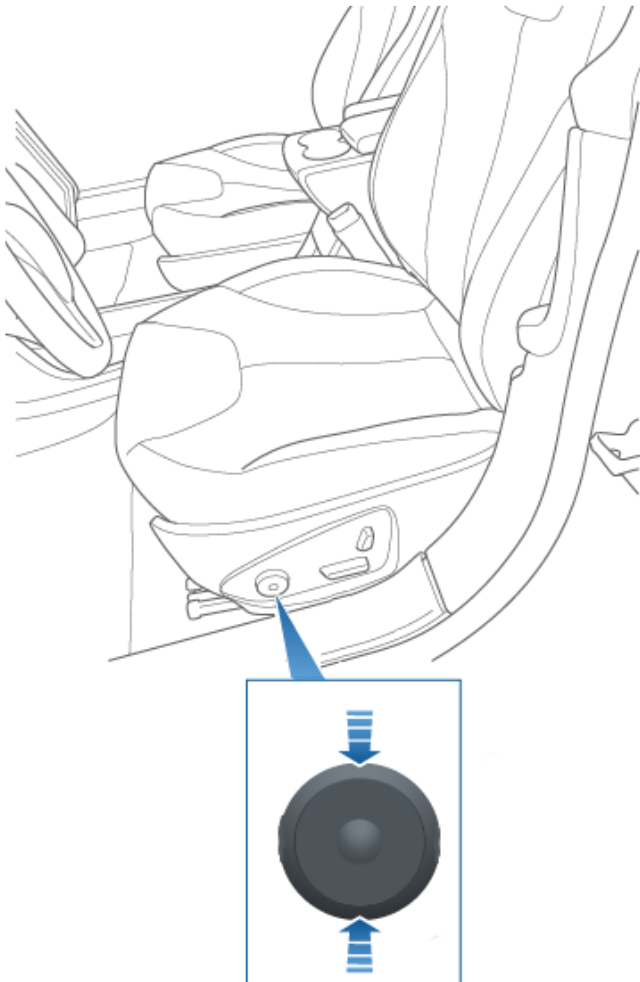

The second and third row seats have integrated non-removable head supports that cannot be adjusted. However, the head supports in the third row seats can be folded down (see [Folding and Raising Third Row Seat Backs \(if equipped\) on page 39](#)).

Seat Heaters

The front seats operate at three levels from 3 (highest) to 1 (lowest). To operate the seat heaters, see [Operating Climate Controls on page 149](#).

If Model X is equipped with the cold weather package, you can also control seat heaters in all rear seating positions, as well as wiper defrosters and washer nozzles by touching the climate controls on the touchscreen.

⚠ WARNING: To avoid burns resulting from prolonged use, individuals who have peripheral neuropathy, or whose capacity to feel pain is limited because of diabetes, age, neurological injury, or some other condition, should exercise caution when using the climate control system and seat heaters.

Seat Covers

⚠ WARNING: Do not use seat covers on a seat equipped with a seat-mounted airbag (see [Location of Airbags on page 61](#)). Doing so could restrict deployment of the seat-mounted side airbags if a collision occurs. Also, if the vehicle is equipped with an occupant detection system that is used to determine the status of the passenger front airbag, seat covers may interfere with this system.



Wearing Seat Belts

Using seat belts and child safety seats is the most effective way to protect occupants if a collision occurs. Therefore, wearing a seat belt is required by law in most jurisdictions.

All seats are equipped with three-point inertia reel seat belts. Inertia reel belts are automatically tensioned to allow occupants to move comfortably during normal driving conditions.

The seat belt reel automatically tightens or locks to prevent movement of occupants if Model X experiences a force associated with hard acceleration, braking, cornering, or an impact in a collision.

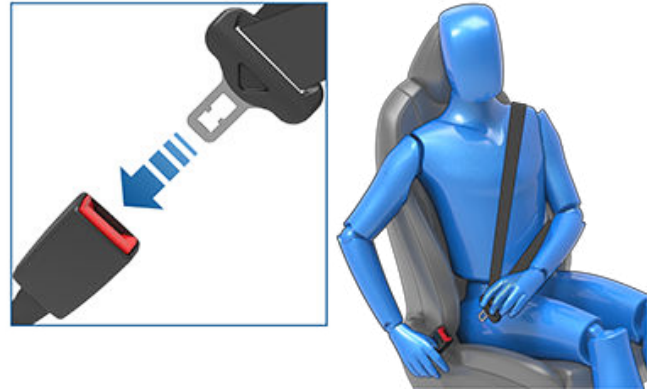

Seat Belt Reminders



The seat belt reminder on the instrument panel alerts you if a seat belt for an occupied driver or passenger seat is unbuckled. If all occupants are buckled up and the reminder stays on, re-buckle seat belts to ensure they are correctly latched. Also remove any heavy objects (such as a briefcase) from an unoccupied seat. If the reminder light continues to stay on, schedule a Service appointment and refrain from using the seat until the issue is resolved.

WARNING: Seat belts must be worn by adult passengers in all seating positions.

NOTE: In regions where regulations require seat belt reminders in rear seating positions, these reminders cannot be disabled. To cancel the reminder in an unoccupied seat when an object is detected, you must either fasten the seat belt or remove the object.

To Fasten a Seat Belt

1. Ensure correct positioning of the seat. See (see [Correct Driving Position on page 36](#)) for details on the correct position of the driver's seat.
2. Pull the seat belt out smoothly, ensuring the seat belt lays flat across the pelvis, chest and mid-point of your collar bone, between the neck and shoulder. Ensure the seat belt is routed correctly and is not twisted. Never sit on the seat belt or any seat belt component.

WARNING: A twisted or incorrectly routed seat belt can cause damage and interfere with the functionality of the seat belt system.

3. Insert the latch plate into the buckle and press together until you hear a click indicating it is locked in place.

4. Pull the seat belt to check that it is securely fastened.
5. Pull the diagonal part of the seat belt toward the reel to remove excess slack.

To Adjust the Shoulder Anchor Height

Model X is equipped with an adjustable shoulder anchor for each front seat to ensure that the seat belt can be positioned correctly. The seat belt should lay flat across the mid-point of your collar bone while in the correct driving position (see [Correct Driving Position on page 36](#)). Adjust the height of the shoulder anchor if the seat belt is not positioned correctly:

1. Press and hold the button on the shoulder anchor to release the locking mechanism.
2. While holding the button, move the shoulder anchor up or down, as necessary, to correctly position the seat belt.

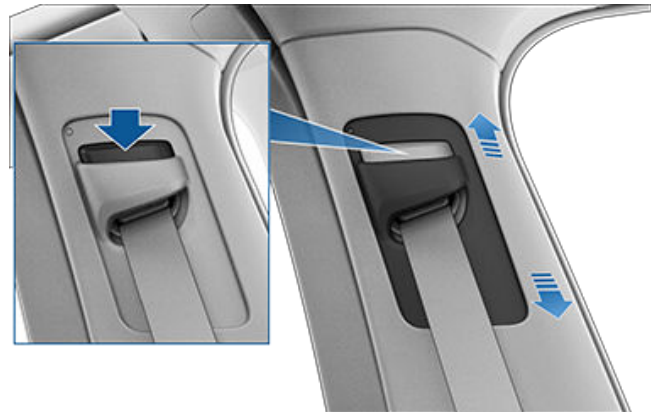

3. Release the button on the shoulder anchor so that it locks into position.
4. Without pressing the button, pull on the seat belt webbing and attempt to move the shoulder anchor downward to check that it is locked into position.

WARNING: Ensure that the seat belt is positioned correctly and that the shoulder anchor is locked into position before driving. Riding in a moving vehicle with the seat belt positioned incorrectly or with the shoulder anchor not locked into position can reduce the effectiveness of the seat belt in a collision.



Seat Belts

To Release a Seat Belt

Hold the seat belt near the buckle to prevent the seat belt from retracting too quickly, then press the button on the buckle. The seat belt retracts automatically. Ensure there is no obstruction that prevents the seat belt from fully retracting. The seat belt should not hang loose. If a seat belt does not fully retract, schedule a Service appointment.

Wearing Seat Belts When Pregnant

Do not put the lap or shoulder sections of the seat belt over the abdominal area. Wear the lap section of the seat belt as low as possible across the hips, not the waist. Position the shoulder portion of the seat belt between the breasts and to the side of the abdomen. Consult your doctor for specific guidance.



WARNING: If the seat belt is uncomfortable, adjust the seating position instead of wearing the seat belt incorrectly.

WARNING: Never place anything between you and the seat belt to cushion the impact in the event of a collision.

Seat Belt Pre-tensioners

The front seat belts are equipped with pre-tensioners that work in conjunction with the airbags in a collision. The pre-tensioners automatically retract both the seat belt lower anchor and the upper shoulder webbing, reducing slack in both the lap and diagonal portions of the seat belts, resulting in reduced forward movement of the occupant.



If the pre-tensioners and airbags did not activate in an impact, this does not mean they malfunctioned. It usually means that the strength or type of force needed to activate them was not present.

The second row outboard seats are equipped with shoulder pre-tensioners to retract the seat belt webbing to reduce forward movement of the occupant.

WARNING: Do not bend, sit on, or interfere with a pre-tensioner assembly. Doing so can cause damage that interferes with the proper functionality of the seat belt system.

WARNING: Once the seat belt pre-tensioners have been activated, they must be replaced. After any collision, have the airbags, seat belt pre-tensioners and any associated components checked and, if necessary, replaced.

Testing Seat Belts

To confirm that seat belts are operating correctly, perform these checks on each seat belt:



1. With the seat belt fastened, give the webbing nearest the buckle a quick and forceful pull. The buckle should remain securely locked.
2. With the seat belt fastened, give the webbing closest to the door a quick and forceful pull. The permanent seat belt attachment should remain securely locked. Never attempt to remove this attachment.
3. With the seat belt unfastened, unreel the webbing to its limit. Check that unreeling is free from snags, and visually check the webbing for wear or damage. Allow the webbing to retract, checking that retraction is smooth and complete.















4. With the webbing half unreeled, hold the tongue plate and pull forward quickly. The mechanism should lock automatically and prevent further unreeling.

If a seat belt fails any of these tests, repair immediately. Do not allow occupants to sit in a seat with a failed seat belt.

For information about cleaning seat belts, see [Seat Belts on page 193](#).

-  **WARNING:** When seat belts are not in use, they should be fully retracted and not hanging loose. If a seat belt does not fully retract, schedule a Service appointment.
-  **WARNING:** The seat belt system has no user serviceable parts and may contain pyrotechnics. Do not disassemble, remove, or replace components.

Seat Belt Warnings

-  **WARNING:** Seat belts should be worn by all occupants at all times, even if driving for a very short distance. Failure to do so increases the risk of injury or death if a collision occurs.
-  **WARNING:** Secure small children in a suitable child safety seat as described in the Owner's Manual. Always follow the child safety seat manufacturer's instructions when installing.
-  **WARNING:** Ensure that all seat belts are worn correctly. An improperly worn seat belt increases the risk of injury or death if a collision occurs.
-  **WARNING:** Never sit on top of any seat belt component. Doing so can cause damage or improper deployment of safety equipment.
-  **WARNING:** Do not wear seat belts over hard, fragile or sharp items in clothing, such as pens, keys, eyeglasses, etc. The pressure from the seat belt on such items can cause injury.
-  **WARNING:** Seat belts should not be worn with any part of the webbing is twisted.
-  **WARNING:** Each seat belt assembly must be used by one occupant only. It is dangerous to put a seat belt around a child being carried on an occupant's lap.
-  **WARNING:** Seat belts that have been worn in a collision must be inspected or replaced by Tesla or a qualified repair facility, even if damage to the assembly is not obvious.
-  **WARNING:** Seat belts that show signs of wear, or have been cut or damaged in any way must be replaced immediately.
-  **WARNING:** Avoid contaminating a seat belt's components with any chemicals, liquids, grit, dirt or cleaning products. If a seat belt fails to retract or latch into the buckle, it must be replaced immediately. Use the mobile app to schedule a Service appointment.
-  **WARNING:** Do not make modifications or additions that can prevent a seat belt mechanism from taking up slack, or that can prevent a seat belt from being adjusted to remove slack. A seat belt with slack greatly reduces occupant protection.
-  **WARNING:** Do not make modifications that can interfere with the operation of a seat belt, or that can cause a seat belt to become inoperable.
-  **WARNING:** Do not use after market comfort and convenience products that attach to the seat belts.



Child Safety Seats

Passenger Front Airbag Must Be OFF

WARNING: If seating a child on the front passenger seat is permitted in your market region, never seat a child on the front passenger seat when the passenger front airbag is active. Always ensure this airbag is OFF (see [Airbags on page 61](#)).

Refer to the following label fitted to the sun visors:



When an infant or child is seated in the front passenger seat (even when the child is seated in a suitable child restraint system or booster seat), the passenger front airbag **MUST** be disabled. If a collision occurs, the inflation of the airbag can cause serious injury or death, especially when using a rear-facing child restraint system.

To disable the passenger front airbag, first ensure the vehicle is in Park. Then touch **Controls > Safety > Passenger Front Airbag** (see [Airbags on page 61](#)).

WARNING: When you disable the passenger front airbag, remember to subsequently enable it when an adult occupant is seated in the front passenger seat.

The status of the passenger front airbag displays in the top corner of the touchscreen. You can also touch this status icon to disable and enable the passenger front airbag:



Before driving with a child seat on the front passenger seat, always double-check the status of the passenger front airbag to confirm that it is OFF.



To protect an adult subsequently occupying the front passenger seat, remember to turn the passenger front airbag back ON.

WARNING: It is the driver's responsibility to confirm that the passenger front airbag is OFF when a child is seated in the front passenger seat.

WARNING: If the passenger front airbag is ON, even if you have turned it OFF (or vice versa), use the mobile app to schedule a service appointment immediately.

Suitability and Fitting of Child Restraint Systems

All Model X seat belts are designed for adults. When seating infants and children, you must:

- Use a child restraint system appropriate for the child's age, weight, or size (see [Recommended Child Restraint Systems on page 44](#)).
- Use a child restraint system that is appropriate for the specific seating position in Model X. For details on what type of child restraint system can be used in each passenger seat, see [Front Passenger Seat on page 47](#), [Second Row Outboard Seats \(Bench Seats\) on page 49](#) or [Second Row Outboard Seats \(Monopost Seats\) on page 51](#), [Second Row Center Seat on page 53](#), and [#unique_161 on page](#) .
- Properly install the child restraint system by following the manufacturer's instructions (see [Installing Belt-based Child Restraint Systems on page 56](#) and [Installing ISOFIX Child Restraint Systems on page 56](#) for general guidelines).

NOTE: When installing a child restraint system, you must also buckle the seat belt to silence the seat belt warning chime.

WARNING: If your Model X is equipped with second row monopost seats, disable **Easy Entry** into the third row whenever installing a child seat in the second row (see [Accessing Third Row Seats \(if equipped\) - Monopost Seating on page 38](#)).

WARNING: If your Model X is equipped with bench seats, disable **Easy Entry** into the first row whenever installing a child seat in the second row (see [Accessing Third Row Seats \(if equipped\) - Bench Seating on page 39](#)).

WARNING: Before driving but after installing a child seat in the second row, ensure that a "seat unlocked" warning does NOT display on the touchscreen or instrument panel. This warning indicates that the seat is unsafe for an occupant because it was not returned to its safe, locked position. If the touchscreen or instrument panel displays the warning message, move the seat or backrest slightly forward or backward until it locks firmly into position and the message no longer displays.

Recommended Child Restraint Systems

In the table below, Tesla provides recommended child restraint systems based a child's weight group (as defined in ECE R44 "Uniform Provisions Concerning Restraining Devices for Child Occupants"). Although all weight groups can occupy any passenger seat in Model X, the type of child restraint system that can be used in each seat can vary. For example, only belt-based child restraint systems (as defined in [Two Installation Methods on page 46](#)) can be used in the rear center passenger seat.



Stature*	Weight Group**	Child Weight	Tesla Recommended
-	Group 0+	Up to 13 kg	Maxi-Cosi CabrioFix with Easybase2, FamilyFix, or EasyFix
45-105 cm	-	-	Maxi-Cosi Pearl 360 with Familyfix 360
-	Group I	9 to 18 kg	Britax Römer DUO PLUS
-	Group II	15 to 25 kg	Britax Römer KIDFIX ² R
100-150 cm	-	-	Britax Römer KIDFIX I-Size
-	Group III	22 to 36 kg	Britax KIDFIX ² R, Peg Perego Viaggio 2-3 Shuttle base

* per R129 CRS maker's rating
 ** per R44 CRS

Britax Römer Kidfix i-Size

When using the Britax Römer Kidfix i-Size child restraint system as recommended by Tesla for children 100-150 cm, you must also use the Britax SecureGuard. When using the Britax SecureGuard, keep the lap belt flat across the child's hips. Do not put the sash belt under the SecureGuard. For details, refer to the instructions provided by Britax.

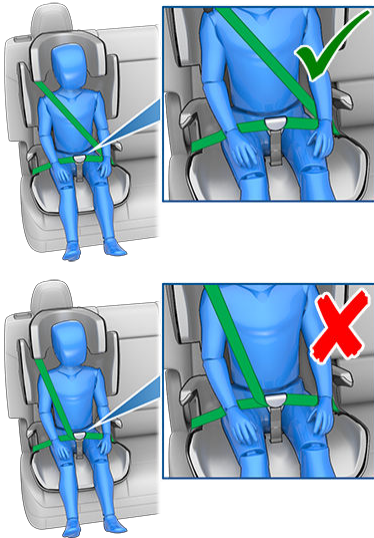



Seating Larger Children

If a child is too large to fit into a child restraint system, but too small to be safely secured using the vehicle's seat belts, use a booster seat appropriate for the child's age and size. When using and installing a booster seat, carefully follow the instructions provided by the manufacturer.

Two Installation Methods

NOTE: Always install child restraint systems by following the instructions provided by the manufacturer of the child restraint system.

Among many other variants, there are two general types of child restraint systems based on how they are secured in the seat:

- Belt-based - secured using the vehicle's seat belts (see [Installing Belt-based Child Restraint Systems on page 56](#)).
- ISOFIX- secured to anchor bars built into the vehicle's seats (see [Installing ISOFIX Child Restraint Systems on page 56](#)).

Some child restraint systems can be installed using either method. Refer to the instructions provided by the manufacturer of the child restraint system to determine which installation method to use and for detailed installation instructions.

In Model X, belt-based child restraints can be installed in any passenger seat and ISOFIX systems can be installed in either of the second row outboard seats and in the third row seats (if equipped). Specific details about the type of child restraint system that can be used in each seat is provided next.

NOTE: ISOFIX is an international standard for integrated anchors used in passenger vehicles to attach child safety seats.

 **WARNING:** Do not use ISOFIX anchors with child restraint system or booster seats that have an integral safety belt where the combined weight of the child plus the child restraint system exceeds 33 kg.



Front Passenger Seat

⚠ WARNING: Never seat a child on the front passenger seat when the passenger front airbag is active. Doing so can cause serious injury or death.

⚠ WARNING: To accommodate a belt-based child restraint system in the front seat, you must raise the seat upward to the mid-height position (raise it approximately 3 cm).

NOTE: The front passenger seat is not equipped with lower anchor bars to support the installation of ISOFIX child restraint systems. The front passenger seat is also not equipped with an upper tether anchor.

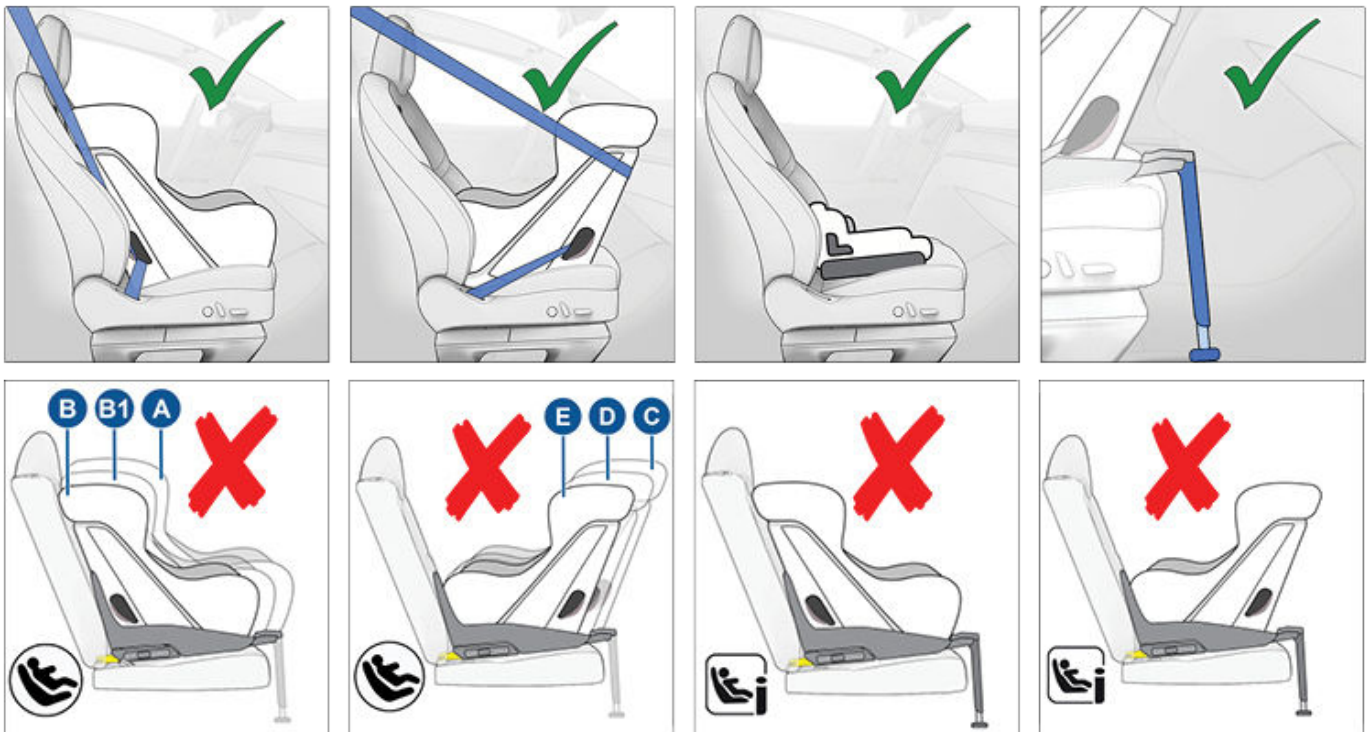

When the passenger front airbag is disabled and the seat bottom is raised half way up, infants and children can occupy the front passenger seat using the following types of belt-based child restraint systems:



Child Safety Seats

- Forward-facing, universal.
- Rear-facing, universal.

Weight Group	Child Weight	Passenger Front Airbag ON	Passenger Front Airbag OFF
Group 0	Up to 10 kg	Not Allowed	Allowed
Group 0+	Up to 13 kg	Not Allowed	Allowed
Group I	9 to 18 kg	Not Allowed	Allowed
Group II	15 to 25 kg	Not Allowed	Allowed
Group III	22 to 36 kg	Not Allowed	Allowed



Second Row Outboard Seats (Bench Seats)

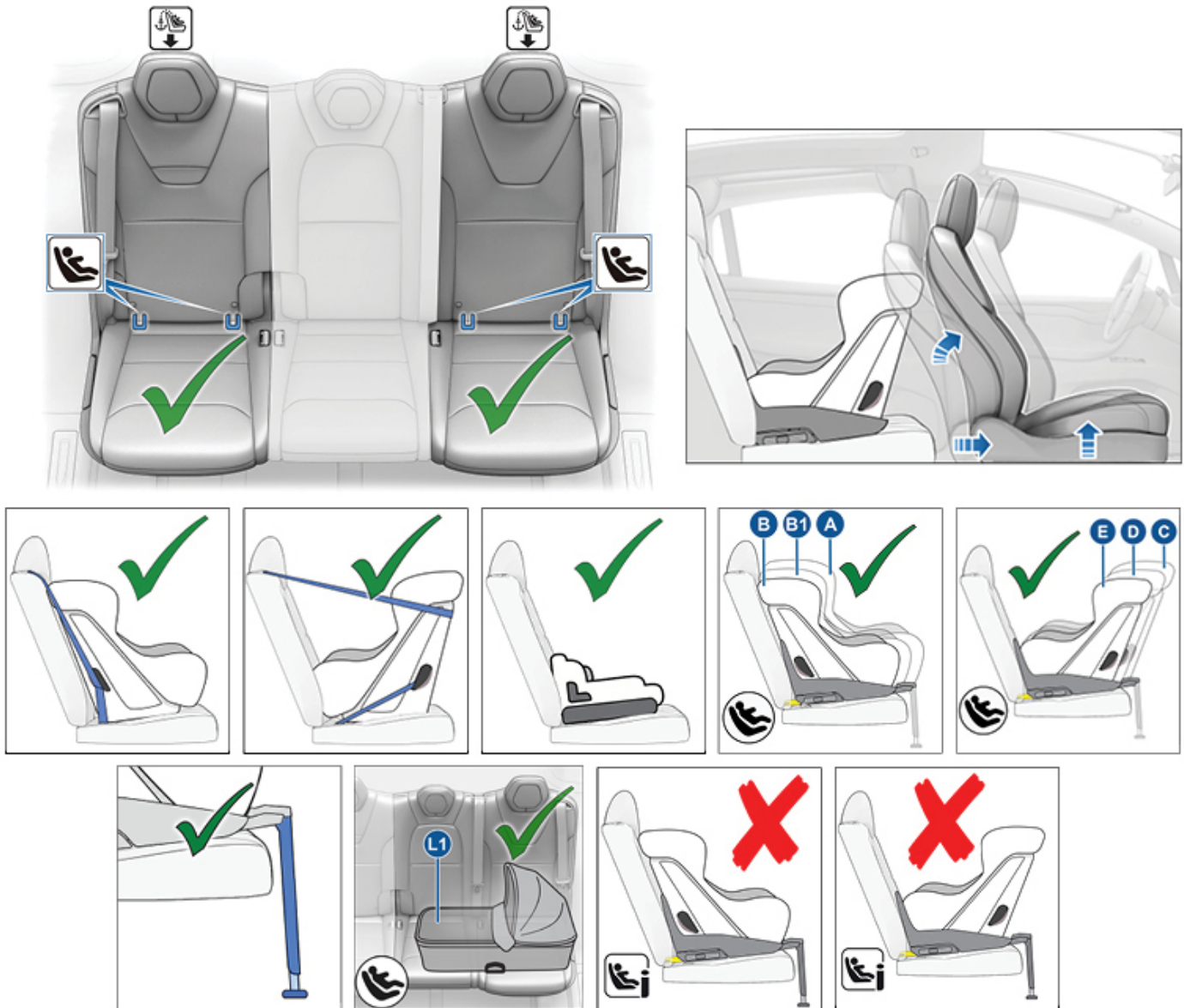

Infants and children can occupy a second row outboard seat using either belt-based, or ISOFIX (IU) child restraint systems. The second row outboard seats support the use of the following ISOFIX size classes:

- Size class A*, B, and B1 forward-facing.
- Size class C*, D and E rear-facing.
- Size class L1 left-facing lateral carrycot.

Larger children can also occupy a rear outboard seat using a Type B2 or B3 booster seat, attached as described in the instructions provided by the child restraint system manufacturer.

NOTE: To accommodate large rear-facing ISOFIX child restraint systems (size class C), you may need to move the seat in the full rearward position, and move the corresponding front seat forward to the mid-track position (up to 13 cm forward of the rearmost position), raise the seat upward (3 cm from its lowest position), and angle the seat back to 15 degrees (or 10 degrees rearward from its forward-most position).

NOTE: The second row outboard seats support the use of upper tether straps (see [Attaching Upper Tether Straps on page 58](#)).



Child Safety Seats

NOTE: All weight groups are supported.

⚠ WARNING: Do not use **Easy Entry** (as described in [Driver Profiles on page 98](#)) to automatically move the driver's seat to the full rearward position if a child safety seat is installed on the rear seat located behind the driver's seat. With reduced clearance, the movement of the seat may impact a child's legs, cause injury, or dislodge the seat.



Second Row Outboard Seats (Monopost Seats)

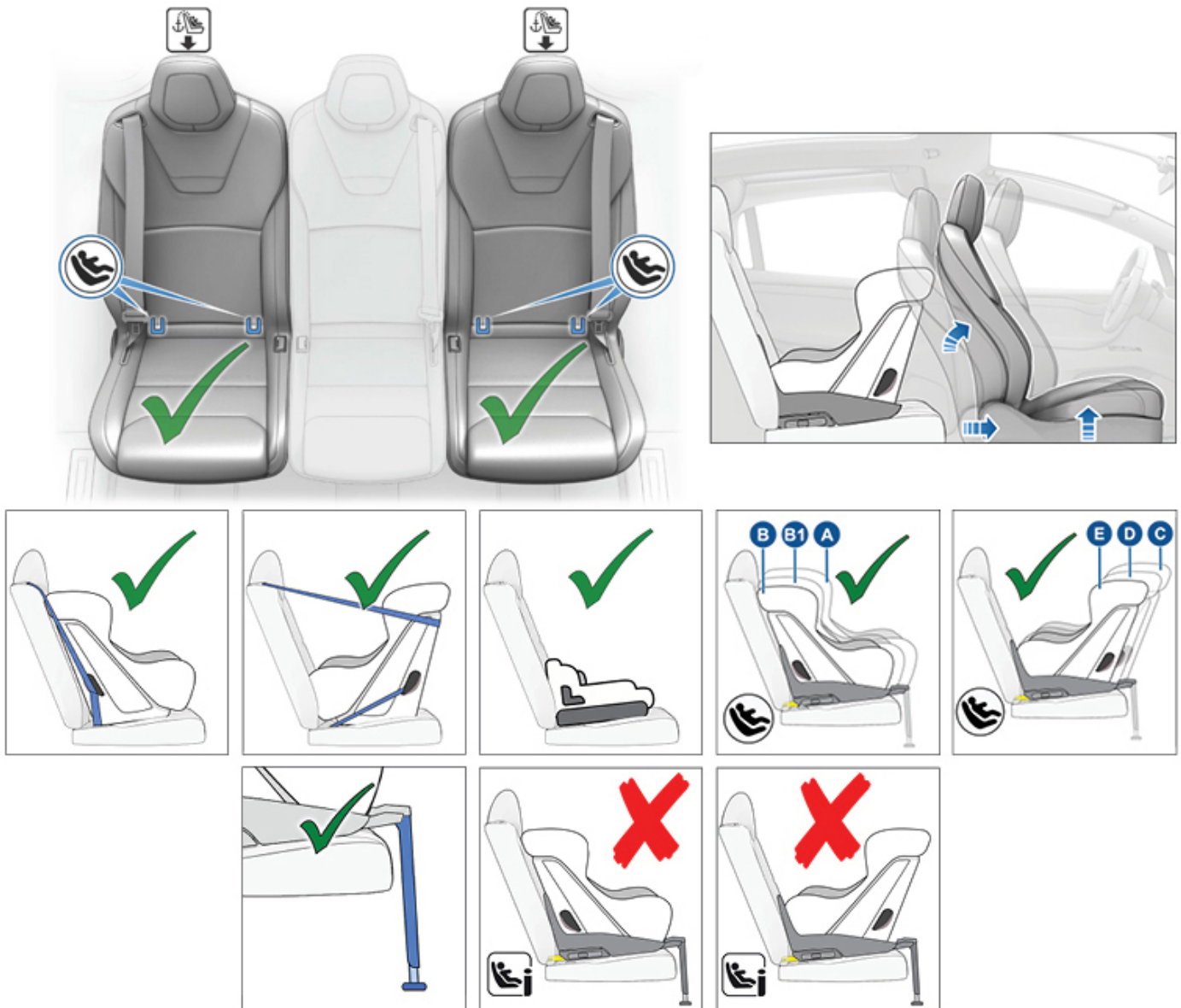

Infants and children can occupy a second row outboard seat using either belt-based or ISOFIX child restraint systems. You can use forward-facing and rear-facing belt-based, ISOFIX child restraint systems in a second row outboard seat. The second row outboard seats support the use of the following ISOFIX size classes:

- Size class A*, B, and B1 forward-facing.
- Size class C*, D and E rear-facing.

Larger children can also occupy a second row outboard seat using a Type B2 or B3 booster seat, attached as described in the instructions provided by the child restraint system manufacturer.



NOTE: To accommodate large rear-facing ISOFIX child restraint systems (size class C), you may need to move the seat in the full rearward position, and move the corresponding front seat forward to the mid-track position (up to 13 cm forward of the rearmost position), raise the seat upward (3 cm from its lowest position), and angle the seat back to 15 degrees (or 10 degrees rearward from its forward-most position).

NOTE: The second row outboard seats support the use of upper tether straps (see [Attaching Upper Tether Straps](#) on page 58).



Child Safety Seats

NOTE: All weight groups are supported.

-  **WARNING:** Do not use **Easy Entry** (as described in [Driver Profiles on page 98](#)) to automatically move the driver's seat to the full rearward position if a child safety seat is installed on the rear seat located behind the driver's seat. With reduced clearance, the movement of the seat may impact a child's legs, cause injury, or dislodge the seat.
-  **WARNING:** For vehicles with third row seats, when a child is seated in a second row monopost seat, the setting for the button that moves a second row outboard seat forward for easy access into the third row should be **OFF** (touch **Controls** > **Seats** > **Easy Entry**). This ensures that you need to manually hold the button to move the seat, preventing a child seated in the second row from being pushed against the corresponding front seat. See [Accessing Third Row Seats \(if equipped\) - Monopost Seating on page 38](#)).



Second Row Center Seat



Infants can occupy the rear center seat using a rear-facing belt-based child restraint system. Children can occupy the rear center seat using either a rear-facing or a forward-facing belt-based child restraint system..

Larger children can occupy the second row center seat using a Type B2 or B3 booster seat, attached as described in the instructions provided by the child restraint system manufacturer.

NOTE: The second row center seat is not equipped with lower anchor bars to support the installation of ISOFIX child restraint systems.

NOTE: All weight groups are supported.

⚠ WARNING: For vehicles with third row seats, do not use the button located on the backrest of a second row outboard **bench seat** when a child is seated in the second row. Using the button tilts and moves the combined left and center seats forward and can squeeze the occupant. Do not rely on Model X to recognize or accommodate occupants seated in the vehicle while using this button. Use this button only when the second row seats are unoccupied. See (see [Accessing Third Row Seats \(if equipped\) - Bench Seating on page 39](#)).

⚠ WARNING: Before driving after installing a child seat in the second row, ensure that a "seat unlocked" warning does NOT display on the touchscreen or instrument panel. This warning indicates that the seat is unsafe for an occupant because it was not returned to its safe, locked position. If the touchscreen or instrument panel displays the warning message, move the seat or backrest slightly forward or backward until it locks firmly into position and the message no longer displays.



Child Safety Seats

Third Row Seats

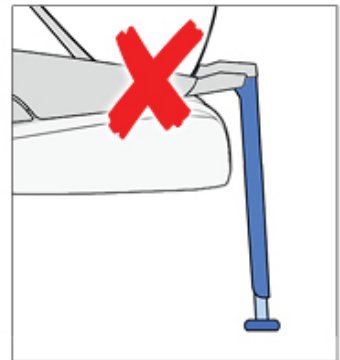

Infants and children can occupy a third row seat using either belt-based or ISOFIX child restraint systems. You can use forward-facing and rear-facing belt-based, and ISOFIX (IU) child restraint systems in a third row seat. The third row seats support the use of the following ISOFIX size classes:

- Size class B, and B1.
- Size class E.

Larger children can also occupy a third row seat using a Type B2 booster seat, attached as described in the instructions provided by the child restraint system manufacturer.



NOTE: To accommodate a large rear-facing child restraint, you may need to move the corresponding second row seats forward, and angle the seat back to 15 degrees (or 10 degrees rearward from its forward-most position) to make room for the child restraint.

NOTE: All weight groups are supported.



Child Safety Seats

Installing Belt-based Child Restraint Systems

Always follow the detailed instructions provided by the manufacturer of the child restraint system. Follow these general guidelines for belt-based child restraint systems:

- Ensure that the child restraint system is appropriate for the weight, height, and age of the child.
- Avoid dressing the child in bulky clothing.
- Do not place any objects between the child and the child restraint system.
- Adjust the child restraint system's harnesses for every child, every trip.

To securely hold child safety seats, all passenger seating positions are equipped with an automatic locking retractor (ALR) that, by pulling the seat belt beyond the length needed for a typical adult occupant, locks the belt into place until the seat belt is unbuckled and the webbing is fully retracted. The ALR mechanism operates as a ratchet, winding in slack and preventing the seat belt from extending any further until it has been completely rewound. When installing a child safety seat, engage the belt's automatic locking retractor by pulling the seat belt webbing until it is **fully** extended. The ALR system engages only when the seat belt is at its maximum extension point.

NOTE: An automatic locking retractor disengages only when the seat belt is unbuckled and fully retracted. The belt can then be worn as a normal belt, sliding freely in and out and locking tight only in an emergency. Once disengaged, the belt must be fully extended to re-engage the locking mechanism whenever you install a child safety seat.

1. Place the child restraint system in the appropriate seat and fully extend the seat belt. Route and buckle the seat belt in accordance with the instructions provided by the manufacturer of the child restraint system.



2. Allow the seat belt to retract, and remove all slack in the seat belt while firmly pushing the child restraint system into the vehicle's seat.

3. Attach the upper tether strap(s), as required by the manufacturer of the child restraint system (see [Attaching Upper Tether Straps on page 58](#)).

Installing ISOFIX Child Restraint Systems

Second row outboard seating positions are equipped with ISOFIX/i-Size anchor bars. These anchor bars are located between the seat's cushion and back rest. The exact location of each anchor bar is identified by a marking (illustrated below) located on the seat back, directly above its associated anchor bars.

Monopost Seats:

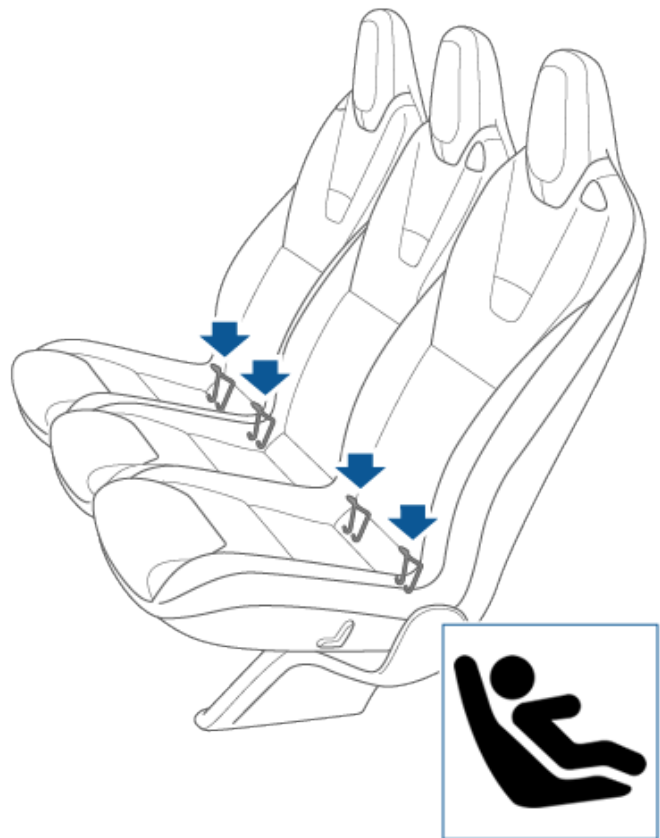

In the second row, install ISOFIX/iSize child safety seats in the outboard seating positions only. Use only a seat belt retained seat in the center position.

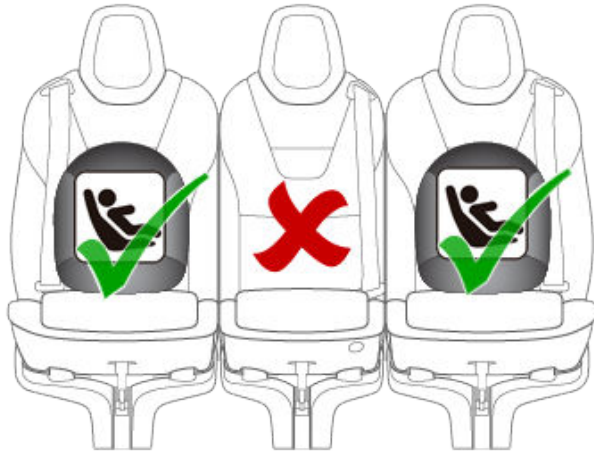

Bench Seats:

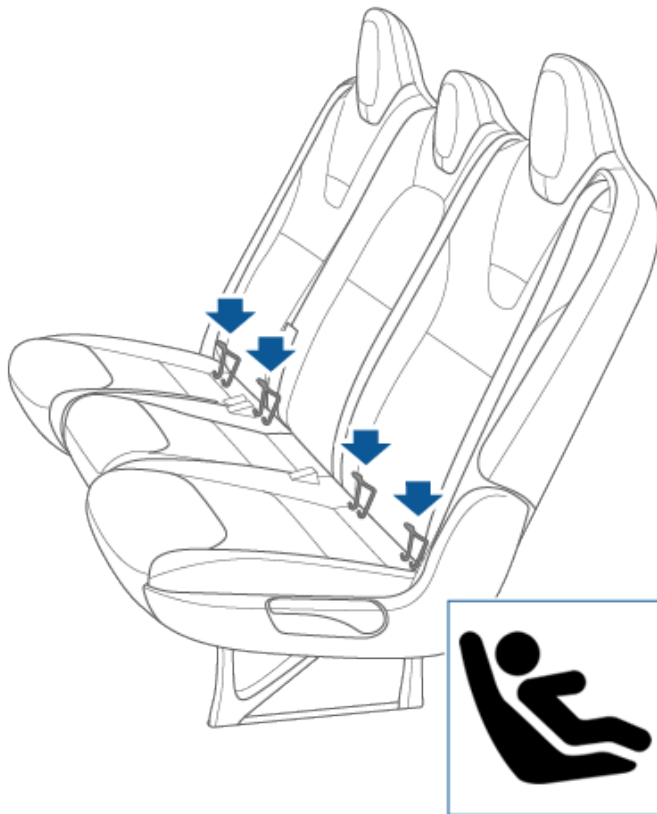

In the second row, install ISOFIX/iSize child safety seats in the outboard seating positions only. Use only a seat belt retained seat in the center position.



To install an ISOFIX/i-Size child restraint system, carefully read and follow the instructions provided by the manufacturer of the child restraint system. These instructions describe how to slide the child restraint system onto the seat's anchor bars until you hear it "click" into place. You may need to push the child restraint system firmly against the seat back to ensure it fits snugly.



Before seating a child, ensure that the child restraint system is securely installed. Grasp the front of the child restraint system with one hand on each side, and attempt to:

- Twist the child restraint system from side to side.
- Pull the child restraint system away from the seat.

If the child restraint system rotates or moves away from the seat, both latches are not fully engaged onto the seat's anchor bars. You must reinstall it and try again. It is critical that both latches on the child restraint system are fully engaged.

⚠ WARNING: Do not use ISOFIX/i-Size anchors with child restraint system or booster seats that have an integral safety belt where the combined weight of the child plus the child restraint system exceeds 33 kg.



Child Safety Seats

Safety Leg

First and second row passenger seats in Model X support the use of a child restraint system with a safety leg. If the child restraint system is equipped with a leg, extend the leg as described in the instructions provided by the manufacturer of the child restraint system.

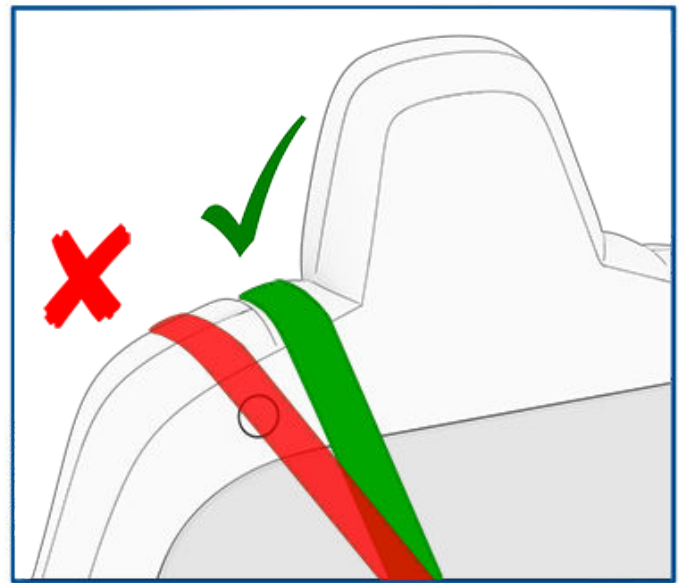
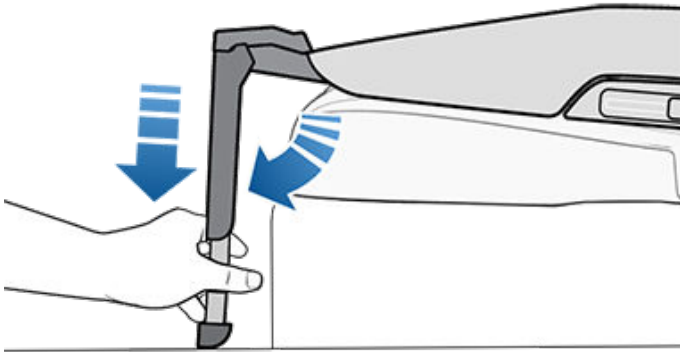

WARNING: USE ONLY SEAT BELT RETAINED CHILD SAFETY SEATS IN THE CENTER SEATING POSITION.

Attaching Upper Tether Straps

Second and third row seats support the use of upper tether straps. When the instructions provided by the manufacturer of the child restraint system include attaching an upper tether strap, attach its hook to the anchor point located behind the associated seat.

NOTE: Tighten upper tether straps according to the instructions provided by the manufacturer of the child restraint system.

The anchor points for tether straps are located on the back of the second and third row seats.

For dual-strap tethers, position a strap on each side of the head restraint.

WARNING: When routing tether straps, keep the strap close to the headrest as illustrated below. On a Model X equipped with third row seats, do not allow a tether strap to cover the third row access button on the rear shoulder of the seat.

Dual Straps - Second Row Monopost Seats:

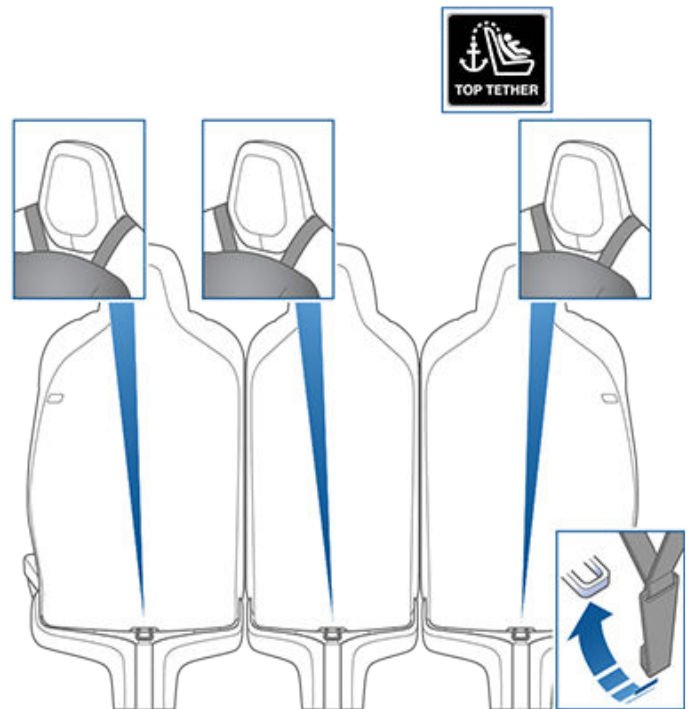

Dual Straps - Second Row Bench Seats:

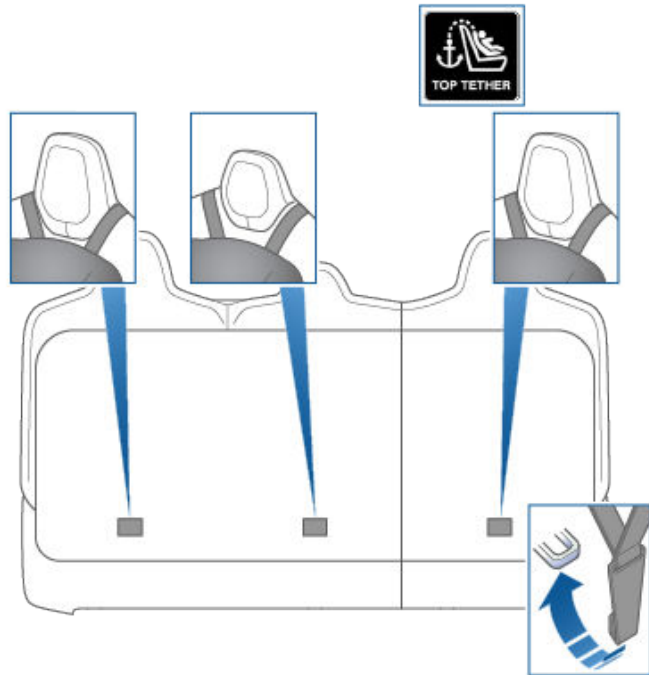

For single-strap tethers, position the strap over the outside-facing side of the head restraint (the same side of the head restraint as the seat belt retraction mechanism).

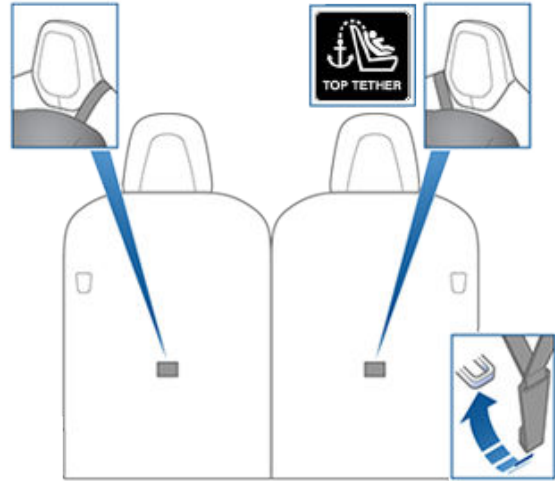

Dual Straps - Third Row Seats

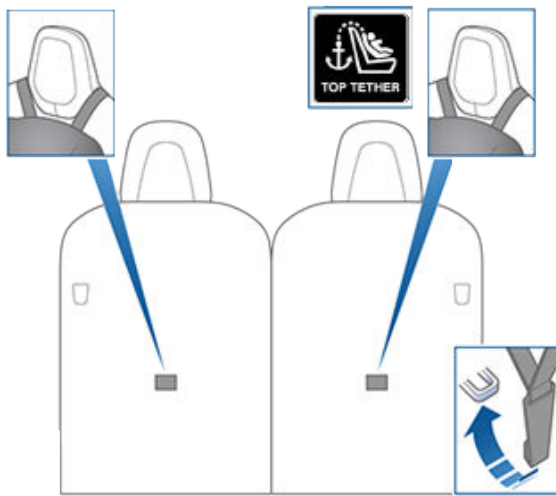

Single Strap - Second Row Monopost Seats:

For single-strap tethers, position the strap in the outboard seating positions over the outside-facing side of the head restraint (the same side of the head restraint as the seat belt retraction mechanism).













Single Strap - Second Row Bench Seats:

For single-strap tethers, position the strap in the outboard seating positions over the outside-facing side of the head restraint (the same side of the head restraint as the seat belt retraction mechanism). In the center seating position (if equipped), center and position the strap over the top of the head restraint.

Single Strap - Third Row Seats



Child Restraint System Warnings

-  **WARNING:** Never use a rearward facing child restraint system on a seat protected by an active passenger front airbag. Doing so can cause serious injury or death. Refer to the warning label located on the sun visor.
-  **WARNING:** Some child restraint systems are designed to be secured in vehicle seats by lap belts or the lap belt portion of a lap-shoulder belt. Children could be endangered in a crash if their child restraint systems are not properly secured in the vehicle.
-  **WARNING:** Do not use a forward-facing child restraint system until your child weighs over 9 kg (20 lbs.) and can sit independently. Up to the age of two, a child's spine and neck are not sufficiently developed to avoid injury in a frontal impact.
-  **WARNING:** Do not allow a baby or infant to be held on an adult's lap. All children should be restrained in an appropriate child restraint system at all times.
-  **WARNING:** To ensure children are safely seated, follow all instructions provided in this document and by the manufacturer of the child restraint system.
-  **WARNING:** The seat belt reminder on the touchscreen is not a substitute for checking if a small occupant or a child safety seat is properly secured. The seat occupancy sensors may not identify small occupants or child seats.
-  **WARNING:** Children should ride in a rear-facing child restraint system using the seat's integrated 5-point harness for as long as possible until they reach the maximum size or weight limit of the rear-facing child restraint system.
-  **WARNING:** When seating larger children, make sure the child's head is supported and the child's seat belt is properly adjusted and fastened. The shoulder portion of the belt must be away from the face and neck, and the lap portion must not be over the stomach.
-  **WARNING:** Never attach two child restraint systems to one anchor point. In a collision, one anchor point may be incapable of securing both seats.
-  **WARNING:** Child restraint anchor bars are designed to withstand only those loads imposed by correctly fitted child restraints. Under no circumstances are they to be used for adult seat belts, harnesses, or for attaching other items or equipment to the vehicle.
-  **WARNING:** Always check harnesses and tether straps for damage and wear.
-  **WARNING:** Never leave a child unattended, even if the child is secured in a child restraint system.
-  **WARNING:** Never use a child restraint system that has been involved in a collision. Discard the seat and have it replaced as described in the child restraint system manufacturer's instructions.

Location of Airbags

Airbags are located in the approximate areas shown below. Airbag warning information is printed on the sun visors.

Model X is equipped with an airbag and lap/shoulder belt (also called seat belt assembly) at both designated front seating positions. The airbag is a supplemental restraint at those seating positions. All occupants, including the driver, should always wear their seat belts whether or not an airbag is also provided at their seating position to minimize the risk of severe injury or death in the event of a crash.

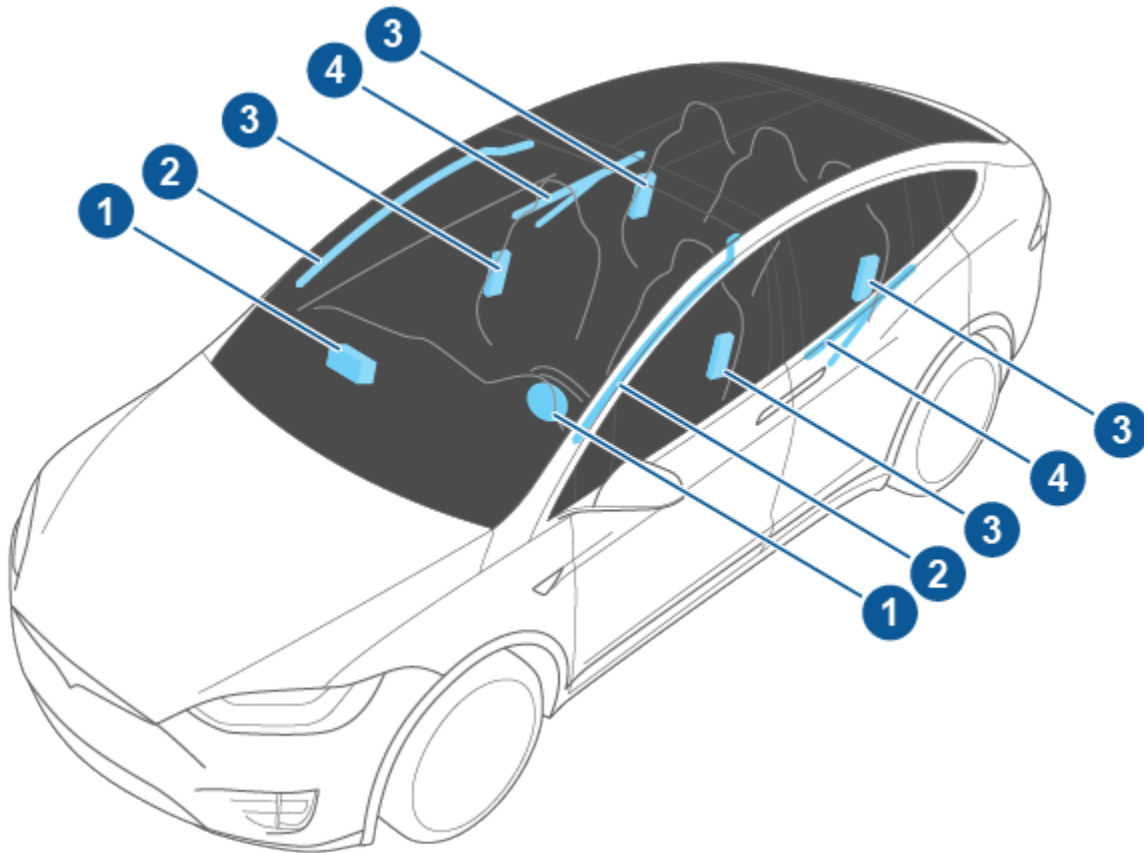

1. Front airbags
2. Curtain airbags
3. Seat-mounted side airbags
4. Door-mounted airbags

How Airbags Work

Airbags inflate when sensors detect an impact that exceeds deployment thresholds. These thresholds are designed to predict the severity of a crash in time for the airbags to help protect the vehicle's occupants. Airbags inflate instantly with considerable force accompanied by a loud noise. The inflated bag, together with the seat belts, limits movement of occupants to reduce the risk of injury.

Front airbags are not ordinarily designed to inflate in rear collisions, rollovers, side collisions and when braking heavily or driving over bumps and potholes. Likewise, front airbags may not inflate in all frontal collisions, such as minor front collisions, underride collisions, or minor impacts with narrow objects (such as posts or poles). Significant superficial damage can occur to the vehicle without the airbags inflating and, conversely, a relatively small amount of structural damage can cause airbags to inflate. Therefore, the external appearance of the vehicle after a collision does not represent whether or not the front airbags should have inflated.



Airbags

WARNING: Before modifying Model X to accommodate a person with disabilities in a way that may affect the airbag system, use the mobile app to schedule service.



To protect an adult occupying the front passenger seat, ensure the passenger front airbag is ON. When the passenger airbag is ON, it may inflate when a collision occurs.

Types of Airbags

Model X has the following types of airbags:

- **Front airbags:** The front airbags are designed to reduce injuries if larger children or adults are riding in the front seats. Follow all warnings and instructions related to seating a child on the front passenger seat (if permitted in your market region).
- **Seat-mounted airbags:** A seat-mounted side airbag in the front seats helps protect the pelvis and the thorax region of the torso. The seat-mounted airbag on the inside portion of the driver's seat helps protect the head and torso. Seat-mounted airbags on both the impacted and non-impacted side of the vehicle inflate in the event of a severe side impact or a severe offset frontal impact.
- **Curtain airbags:** A curtain airbag on each side of Model X in the front roof-rail help protect the head. Curtain airbags on both the impacted and non-impacted side of the vehicle will inflate if a severe side impact occurs, a severe offset frontal impact occurs, or if the vehicle rolls over.
- **Door-mounted airbags:** There is an airbag on each side of Model X mounted in the trim on the falcon wing doors. These are the same as the curtain airbags in that they help protect the head and typically inflate in the event of a severe side impact, a severe offset frontal impact, or if the vehicle rolls over. The door-mounted airbags on both the impacted and non-impacted side of the vehicle will inflate.



The airbag indicator on the instrument cluster remains lit if the airbag system is malfunctioning. The only time this indicator should illuminate is briefly when Model X first powers up, in which case it turns off within a few seconds. If it remains illuminated, use the mobile app to schedule a service appointment immediately and do not drive.

WARNING: If seating a child in the front passenger seat is legally permitted in your market region, it is the driver's responsibility to ensure that the passenger front airbag is OFF. Never seat a child in the front passenger seat with an active airbag, even if using a child restraint system or booster seat. DEATH or SERIOUS INJURY to the child can occur.

Controlling the Passenger Front Airbag

When a child is seated in the front passenger seat (if legally permissible in your market region), even when the child is seated in a child restraint system or booster seat), you must ensure the passenger front airbag is disabled to prevent the child from injury or death that may be caused by the forceful inflation of the airbag if a collision occurs. Toggle the airbag switch OFF before placing a child seat in the front passenger seat.

To control the front airbag on the passenger side of the vehicle, first ensure the vehicle is in Park. Then touch **Controls > Safety > Passenger Front Airbag**. Then choose from:

- Touch **OFF** to manually disable the airbag.
- Touch **ON** to manually enable the airbag.

WARNING: When you turn it off manually, you must touch **ON** to manually enable it again to protect an adult occupant seated in the front passenger seat.

- Touch **AUTO** to turn the front passenger airbag off and on automatically based on an occupant sensor in the seat:

Weight in front passenger seat	Passenger airbag status	Indicator status
Empty	OFF	PASSENGER AIRBAG OFF**
Up to 9 kg	OFF	PASSENGER AIRBAG OFF

Airbag Status Indicator

The status of the passenger front airbag displays on the touchscreen:



The Passenger Airbag Off indicator displays on the touchscreen when the passenger front airbag is OFF. When the passenger front airbag is OFF, it does not inflate when a collision occurs. This indicator also displays when the seat is unoccupied. When driving with a child seat on the front passenger seat (if permitted in your market region), always double-check the status of the passenger front airbag to confirm that it is OFF.

NOTE: In cars manufactured prior to approximately October 2019, the Passenger Airbag Off indicator does not display when the seat is unoccupied.

Weight in front passenger seat	Passenger airbag status	Indicator status
9-45 kg*	OFF or ON	OFF - PASSENGER AIRBAG OFF ON - PASSENGER AIRBAG ON
Over 45 kg	ON	PASSENGER AIRBAG ON

*Values are approximate. A weight detected near the threshold can cause the airbag status to occasionally turn on and off depending on seating position and physique.

**In cars manufactured prior to approximately October 2019, the Passenger Airbag Off indicator does not display when the seat is unoccupied.

NOTE: It takes approximately six seconds after you power on Model X for the occupancy sensor to report accurate status of the front passenger airbag. As a result, when you first power on Model X, even in situations when it should be OFF because the seat is occupied by a weight of 9 kg or less, it will take the touchscreen approximately six seconds to display the status, PASS AIRBAG OFF. If it fails to do so, use the mobile app to schedule a service appointment immediately and do not seat a child in the front passenger seating position.

To make sure the sensing system can correctly detect occupancy status, eliminate the following:

- Objects lodged under the seat.
- Heavy objects sitting on the seat (briefcase, large purse).
- Objects wedged between the seat back and seat cushion.
- Cargo interfering with the seat.
- Aftermarket items attached to, or sitting on, the seat (covers, mats, blankets, etc.).

These conditions can interfere with the occupancy sensor. If you have eliminated the above possibilities, and the airbag status is still incorrect, ask passengers to ride in the rear seats and use the mobile app to schedule a service appointment to have the airbag system checked.

NOTE: The front passenger seat's sensing system affects the operation of the passenger front airbags only. Other passenger airbags are not affected.

WARNING: If the front passenger airbag is not turning on or off as expected based on the weight thresholds previously described, use the mobile app to schedule a service appointment.

WARNING: To ensure accuracy of the occupant detection system, do not make any modifications to the front passenger seat.

NOTE: Model X has a capacitive touchscreen and may not respond to your touch if you are wearing standard gloves. If the touchscreen is not responding, remove gloves or wear gloves with conductive fingertips for use with capacitive touchscreens.

WARNING: If the passenger front airbag does not appear to be functioning (for example, if the airbag is on, even if you have turned it off, or vice versa), do not seat a passenger in the front seat. Use the mobile app to schedule a service appointment immediately.

WARNING: It is the driver's responsibility to confirm that the passenger front airbag is OFF when a child is seated in the front passenger seat. Do not rely on the occupant detection system to turn off the airbag. Before driving with a child seated on the front passenger seat, always double-check that the passenger airbag status displays on the touchscreen to indicate the airbag is off.

WARNING: Never seat a child in a child restraint system or a booster seat on the front passenger seat when the airbag is active. Doing so can cause serious injury or death.

Examples of Correct and Incorrect Seating Positions

Correct seating position:



Incorrect seating position - the passenger's feet must be on the floor:



Airbags

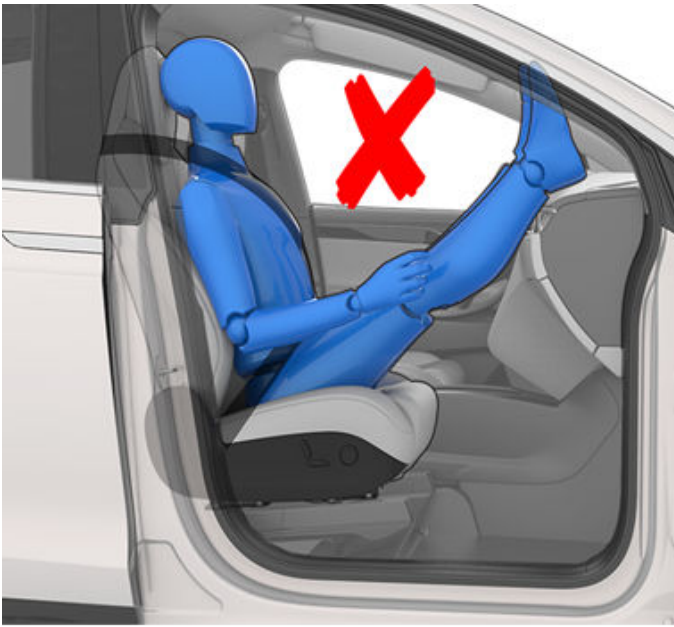

Incorrect seating position - the passenger must not slide forward on the seat cushion:

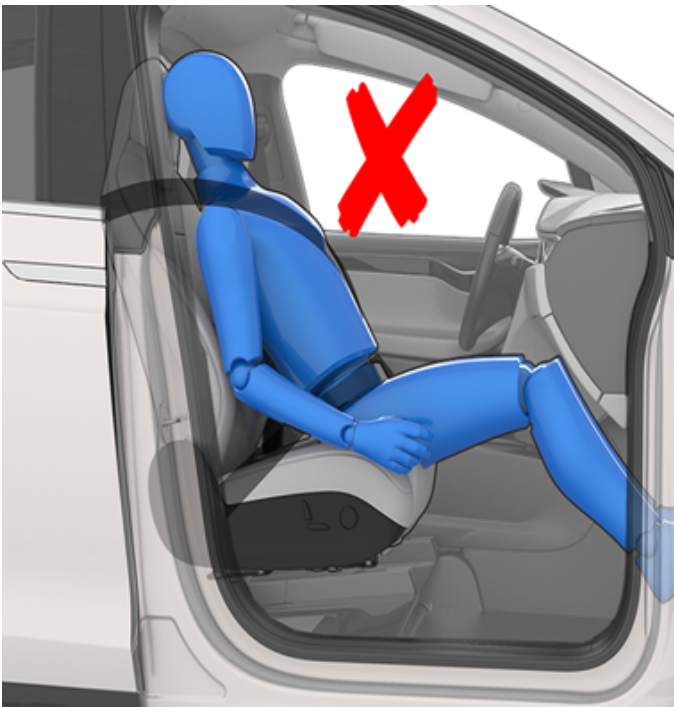

Incorrect seating position - the passenger must not recline the backrest to a laying down position when the vehicle is moving:

Inflation Effects

⚠ WARNING: When airbags inflate, a fine powder is released. This powder can irritate the skin and should be thoroughly flushed from the eyes and from any cuts or abrasions.

After inflation, the airbags deflate to provide a gradual cushioning effect for the occupants and to ensure the driver's forward vision is not obscured.

If airbags have inflated, or if your vehicle has been in a collision, always have the airbags, seat belt pre-tensioners and any associated components checked and, if necessary, replaced by Tesla.











In a collision, in addition to the airbags inflating:

- Doors and liftgate unlock.
- Hazard warning lights turn on.
- Interior lights turn on.
- High voltage is disabled (you must use the mobile app to schedule a service appointment to restore high voltage power).
- Windows go to the vent position.
- Vehicle applies the brakes to come to a stop.

NOTE: Depending on the nature of the impact and the forces involved, doors may not unlock in a collision and/or damage may prevent them from opening. In such cases, the door may need to be opened using the interior manual release, or other means of extrication (for example, exiting through another door, breaking the window, etc.).



Airbag Warnings

-  **WARNING:** All occupants, including the driver, should always wear their seat belts, whether or not an airbag is also provided at their seating position, to minimize the risk of severe injury or death in the event of a collision.
-  **WARNING:** Front seat occupants should not place their arms over the airbag module, as an inflating airbag can cause fractures or other injuries.
-  **WARNING:** Do not use seat covers on Model X. Doing so could restrict deployment of the seat-mounted side airbags if a collision occurs. It can also reduce the accuracy of the occupant detection system, if equipped.
-  **WARNING:** Airbags inflate with considerable speed and force, which can cause injury. To limit injuries, ensure that occupants are wearing seat belts and are correctly seated, with the seat positioned as far back as possible.
-  **WARNING:** Do not use a rear-facing child restraint system on a seat with an operational airbag in front of it. Doing so can cause injury or death if the airbag inflates.
-  **WARNING:** To ensure correct inflation of the side airbags, maintain an unobstructed gap between an occupant's torso and the side of Model X.
-  **WARNING:** Passengers shouldn't lean their heads against doors. Doing so can cause injury if a curtain airbag inflates.
-  **WARNING:** Do not allow passengers to obstruct the operation of an airbag by placing feet, knees or any other part of the body on or near an airbag.
-  **WARNING:** Do not attach or place objects on or near the front airbags, the side of the front seats, the headliner at the side of the vehicle, or any other airbag cover that could interfere with inflation of an airbag. These include but are not limited to: steering wheel covers, decals, seat cushions, pillows, etc. Objects can cause serious injury if the vehicle is in a collision severe enough to cause the airbag to inflate.
-  **WARNING:** Following inflation, some airbag components are hot. Do not touch until they have cooled.



Mobile App

The Tesla mobile app allows you to communicate with Model X remotely using your iPhone® or Android™ phone.

NOTE: The information below may not represent an exhaustive list of the functions available on the Tesla mobile app. To ensure access to new and improved features, download updated versions of the mobile app as they become available.

To Use the Mobile App

To set up the Tesla mobile app to communicate with your Model X:

1. Download the Tesla mobile app to your phone.
2. Log in to the Tesla mobile app by entering your Tesla account credentials.
3. Enable mobile access to your Model X by touching **Controls > Safety > Allow Mobile Access**.

Your phone and vehicle must both be actively connected to cellular service or Wi-Fi for the mobile app to communicate with your vehicle. Tesla recommends that you always have a functional physical key readily available if parking in an area with limited or absent cellular service, such as an indoor parking garage.

NOTE: In the event that you require lockout assistance from Tesla due to a non-warranty issue, such as having limited cellular connectivity and having no secondary key available, your expenses are not covered under the Roadside Assistance policy.

NOTE: Tesla does not support the use of third party applications to contact Model X.

Mobile App for Apple Watch

You can also use the mobile app on your Apple Watch.

The Tesla mobile app for Apple Watch requires:

- An Apple Watch Series 6, Apple Watch SE 2, or Apple Watch Ultra 1 or newer with watchOS 11.0 or newer.
- Vehicle firmware version 2024.44.25 or newer.
- Tesla Mobile app version 4.39.5 or newer.

Before using the Tesla mobile app on your Apple Watch, ensure that your iPhone and Apple Watch are updated to the latest available software version. To add the Tesla mobile app to your Apple Watch, use the Watch app on your iPhone.

You can use the Tesla Apple Watch app to lock and unlock Model X, open the trunk, and open the frunk.

In addition, you can use your Apple Watch as a key the same way you would use your phone as a key. For more information, see [#unique_181 on page](#) .

Overview

When both your phone and the vehicle have internet service, the Tesla mobile app's home screen allows you to:

- Lock or unlock your vehicle.
- Enable or disable the heating or air conditioning and monitor the cabin climate.
- Check your vehicle's charging information. Charging details also appear when a charging cable is plugged in.
- Open or close the charge port.
NOTE: Twisting red lines next to the Battery icon indicate that the Battery is actively heating up (including while charging or preparing to charge).
- See where your vehicle is located.
- View your vehicle's estimated range.
- Open the front trunk.
- View your vehicle's odometer, VIN, and current software version.

Media settings appear on the mobile app to pause, play, rewind, fast forward, and adjust the volume of the media currently playing in the vehicle. You may need to enable Media settings by touching **Audio Settings > Options > Allow Mobile Control**.

For supported video sources, send videos to Tesla Theater by sharing the link through the mobile app. Navigate to the movie, show, or video you want to play on your phone and touch the share button. Share the video with the Tesla app and it appears on the touchscreen if Model X is in Park.

Profile

In the Profile tab located at the top corner, you can:

- Switch to a different vehicle associated with your Tesla account, if you have access to more than one.
- Navigate the Tesla Shop.
- Manage your account information and view your order history.
- View and customize notifications you receive under the Settings tab, such as Calendar sync, when your security alarm has been triggered, charging updates, and new software updates. You can start updates from afar and check its progress.

Controls

The Controls tab allows you to do the following:

- Open the front or rear trunk.
- Lock or unlock Model X from afar.

NOTE: Your vehicle does not automatically re-lock if you unlock from the mobile app.

- Open or close the charge port.
- Flash the lights or honk the horn to find where Model X is parked.
- Enable Keyless Driving.

NOTE: Keyless Driving can be used when you do not have your key or to bypass PIN to Drive in cases where you forgot your PIN or your touchscreen is unresponsive (see [PIN to Drive on page 143](#)).

- Open and close your garage door if your vehicle has a programmed HomeLink connection, if available (see [Smart Garage on page 73](#)).
- Vent the windows.

Climate

You can check the interior temperature and heat or cool the cabin before driving (even if it's in a garage), control the seat heaters, and defrost the windshield:

- Enable or disable defrost, which helps melt snow, ice, and frost on the windshield, windows, and mirrors, by swiping up from the bottom of the screen.
- Vent the windows.
- Precondition the cabin to your desired temperature and turn on or off the steering wheel and seat heaters (if equipped).

Using the mobile app to precondition Model X also warms the Battery as needed. The mobile app will notify you once your vehicle has reached the desired preconditioning temperature.

NOTE: In extremely cold weather or icy conditions, it is possible that your charge port latch may freeze in place. In cases where you cannot remove or insert the charge cable, or the vehicle is not Supercharging due to the latch being frozen in place, use your Tesla mobile app to precondition your vehicle on **HI** for approximately 30–45 minutes (you must use your mobile app to precondition the vehicle; setting your climate to **HI** using the touchscreen is not effective). This can help thaw ice on the charge port latch so the charge cable can be removed or inserted.

Location

Locate Model X with directions, or track its movement across a map.

Summon

You can park or retrieve Model X using .

Schedule

Enable scheduled charging or departure, and precondition the vehicle. See [Scheduled Precondition and Charge on page 178](#) for more information. Scheduled charging or departure can also be saved based on a preferred location.

You can also schedule a light show for a future time. For more information about light show, see [Theater, Arcade, and Toybox on page 165](#).

Security

The Security tab allows you to do the following:

- Enable or disable Sentry Mode (see [How to Use Sentry Mode \(With a USB Flash Drive\) on page 146](#)).
- Enable or disable Valet Mode (see [Valet Mode on page 98](#)).
- Enable or disable Speed Limit Mode and receive notifications when the vehicle's driving speed is within approximately 5 km/h of your selected maximum speed (see [Speed Limit Mode on page 143](#)).

Upgrades

View and purchase the latest upgrades available for your vehicle, such as full self-driving.

Service

See [Schedule Service on page 183](#) for information on how to schedule service through the mobile app.

Roadside

View roadside resources and request roadside assistance (where applicable). For more information on Roadside Assistance, see [Contacting Tesla Roadside Assistance on page 215](#).

Granting Access to a Second Driver

Add and remove access permission for an additional driver from the Tesla mobile app.

NOTE: Tesla mobile app version 4.3.1 or higher is required. Additional drivers can either use a previously registered Tesla Account or use the app to create a new Tesla Account.

To add an additional driver, in the Tesla mobile app from the vehicle home screen, go to **Security > Add Driver** and follow the onscreen instructions.

NOTE: The additional driver has access to all app features except purchasing upgrades.

To remove access, use the mobile app and go to **Security > Manage Drivers** and follow the onscreen instructions.



Wi-Fi is available as a data connection method and is often faster than cellular data networks. Connecting to Wi-Fi is especially useful in areas with limited or no cellular connectivity. To ensure fast, reliable delivery of software and map updates, Tesla recommends leaving Model X connected to a Wi-Fi network whenever possible (for example, when parked at home).

To connect to a Wi-Fi network:

1. Touch **Controls** > **Wi-Fi**. Model X begins to scan and display detected Wi-Fi networks that are within range.

NOTE: If a known Wi-Fi network does not appear in the list, move Model X closer to the access point or consider using a range extender.

NOTE: When connecting to a 5GHz network (if available), check which channels are supported in your region.

5GHz Network Channels Supported

36-48	52-64	100-140	149-165
✓	✓	✓	✓

2. Find and tap the Wi-Fi network you want to use in **Searching for Wi-Fi Networks** or add it manually in **Add Wi-Fi Networks**, enter the password (if necessary), then touch **Confirm**. When successfully connected, the Wi-Fi network shows in **Known Wi-Fi Networks** along with a green check. Whenever the network is within range, Model X connects to it automatically.

NOTE: Model X does not currently support connections to captive Wi-Fi networks (a captive Wi-Fi, commonly used by public hotspots, requires you to access a custom web portal and agree to terms of service prior to allowing you to log in).

NOTE: If more than one previously connected network is within range, Model X connects to the one most recently used.

NOTE: At Tesla Service Centers, Model X automatically connects to the Tesla Service Wi-Fi network.

Diagnostics

Diagnostics offers more information on your Wi-Fi connection, as well as connection improvement tips. To access, navigate to **Wi-Fi** > **Diagnostics** or find it below the progress bar while a software update downloads or installs.

Hotspots

Instead of a Wi-Fi network, you can also use a mobile hotspot (subject to fees and restrictions of your carrier). After connecting to your hotspot, select **Remain Connected in Drive**, if you want to keep the connection active while you are driving.

Troubleshooting Tips

If your vehicle's Wi-Fi connection is slow or it fails to connect, try these tips.

- On the touchscreen, check the number of Wi-Fi icon bars (signal strength). If the bars are low, consider adding a Wi-Fi access point closer to the vehicle to improve the signal.
- Restart the touchscreen (see [Restarting the Touchscreen or Instrument Panel on page 8](#)).
- Remove the Wi-Fi connection and reconnect. Touch **Controls** > **Wi-Fi**, select your network and **Forget Network** then reconnect by touching your network in **Known Networks**.
- Try a different Wi-Fi network.

Bluetooth® Compatibility



You can use various Bluetooth devices in Model X provided it is paired and within operating range. For example, you can pair your Bluetooth-capable phone so you can use it hands-free. In addition to phones, you can pair other Bluetooth-enabled devices with Model X. For example, you can pair an iPod Touch, iPad, Android tablet, etc. from which you can play music.

Before using your phone or other Bluetooth device with Model X, you must pair it. Pairing sets up Model X to communicate with supported Bluetooth-capable devices. You can pair up to ten Bluetooth phones. Unless you've specified a specific phone as a **Priority Device**, or if the phone specified as **Priority Device** is not within range, Model X always connects to the last phone that was used (provided it is within range). To connect to a different phone, see [Switching Between Paired Devices on page 70](#).

NOTE: On many phones, Bluetooth turns off if the phone's battery is low.

NOTE: Although Bluetooth typically supports wireless communication over distances of up to approximately nine meters, performance can vary based on the phone, or other device, you are using.

NOTE: Model X can pair up to twenty Bluetooth devices at a time but only allows two devices to connect simultaneously (such as one phone and one controller or two controllers) to each front and rear touchscreen (if equipped).



CAUTION: Do not leave your paired phone in your vehicle (for example, if you are hiking or at the beach). If you must leave your phone in the vehicle, disable Bluetooth and/or turn the phone off.

Pairing a Phone or Bluetooth Device

Pairing allows you to use your Bluetooth-capable phone hands-free to make and receive phone calls, access your contact list, recent calls, etc. It also allows you to play media files from your phone. Once a phone is paired, Model X can connect to it whenever the phone is within range.

1. To pair a phone or a Bluetooth device, sit inside Model X and ensure the touchscreen is on.
2. Unlock your phone and enable Bluetooth (typically in Settings on your phone).

NOTE: On some phones, this may require you to go to Bluetooth Settings for the remainder of the procedure.

3. On the touchscreen, touch **Controls > Bluetooth** to automatically start Bluetooth scanning for new devices.
4. Wait for your phone to be listed and touch **Connect**.
5. Check that the number displayed on your phone matches the number on the touchscreen. Then, on your phone, confirm that you want to pair.

6. If prompted on your phone, specify whether you want to allow Model X to access your personal information, such as calendar, contacts and media files (see [Importing Contacts and Recent Calls on page 69](#)). When paired, Model X lists your phone under **Controls > Bluetooth > Paired Devices**.

To change the settings of a paired device, go to **Controls > Bluetooth > Paired Devices** and expand the dropdown next to the device's name.

If you are experiencing issues importing or connecting to Bluetooth, see [Troubleshooting Bluetooth on page 70](#) for more information.

For vehicles manufactured prior to approximately April 2018: If Bluetooth takes an exceptionally long time to pair, reset Bluetooth functionality by touching **Controls > Service > Reset Bluetooth**. You may need to wait a few minutes. Once reset, try pairing to Model X again. After you reset Bluetooth, Model X may forget previously paired devices.

Importing Contacts and Recent Calls

Once a phone is paired, go to **Controls > Bluetooth > Paired Devices** and expand the dropdown next to the device's name to specify whether you want to allow access to your phone's contacts, recent calls and text messages. If you allow access, you can use the phone app to make calls and send messages to people in your list of contacts and on your recent calls list (see [Phone, Calendar, and Web Conferencing on page 71](#)). Before contacts can be imported, you may need to either set your phone to allow syncing, or respond to a popup on your phone to confirm that you want to sync contacts. This varies depending on the type of phone you are using. For details, refer to the documentation provided with your phone.

If you are having trouble importing contacts or pairing with Bluetooth, see [Troubleshooting Bluetooth on page 70](#) for more information.

Disconnecting or Unpairing a Bluetooth Device

If you want to disconnect your phone or Bluetooth device, but keep it paired, touch **Disconnect** in your phone's Bluetooth settings dropdown on the touchscreen (**Controls > Bluetooth > Paired Devices > Your phone**). If you no longer want to use your device with Model X, touch **Forget Device** and follow the instructions. Once you forget a device, you must pair it again if you want to use it with Model X (see [Pairing a Phone or Bluetooth Device on page 69](#)).

NOTE: Your phone automatically disconnects when you leave Model X.



Switching Between Paired Devices

Model X automatically connects to a phone that you designated as **Priority Device**. If you have not set a phone as a priority, Model X connects to the last phone to which is was connected, provided it is within operating range and has Bluetooth turned on. If the last phone is not within range, it attempts to connect with the next phone that it has been paired with.

To connect to a different phone, touch **Controls > Bluetooth > Paired Devices**. Select the phone you want to connect to, then touch **Connect**. If the phone you want to connect to is not listed, you must pair the phone. See [Pairing a Phone or Bluetooth Device on page 69](#).

When connected, the Bluetooth settings screen displays the Bluetooth symbol next to the phone's name to show that Model X is connected to the phone.

Troubleshooting Bluetooth

Your vehicle uses Bluetooth and BLE (Bluetooth Low Energy) to seamlessly connect your smartphone to Model X. Due to several potential factors, Bluetooth or BLE may sometimes disconnect or experience issues in the pairing process. Connecting to Bluetooth allows your vehicle to use phone functions such as audio, phone calls, calendars, text messages, etc.

BLE is used for passive functions like phone key.

NOTE: Do not unpair your vehicle to your phone or remove it as phone key without a working key card nearby.

Try the following to troubleshoot Bluetooth, starting with your smartphone.

Smartphone Troubleshooting

Bluetooth may not connect due to settings and updates on your smartphone:

- Enable Bluetooth on your phone. If already enabled, disable and re-enable Bluetooth again.
- Ensure Airplane Mode is turned off.
- Charge your phone; if your phone battery is too low, it may not support Bluetooth functions.
- Pair your device properly. If already paired, try unpairing and re-pairing again.
- Update your phone to the latest software provided by the manufacturer.
- Check that your vehicle's sound system is selected as the audio output source.
- Ensure your phone's settings allow for Bluetooth (ex: data is turned on or you are connected to Wi-Fi).
- Turn your phone off and on again.

- Ensure location permissions set to "Always On" for the mobile app.

Tesla Mobile App Troubleshooting

Check the Tesla mobile app:

- Confirm the Tesla mobile app is up to date on software.
- Verify you're logged into the Tesla mobile app while using your phone key.
- Ensure the Tesla app is running in the background.
- Double check that you have completely set up your profile in the mobile app and properly configured your settings.

Vehicle Troubleshooting

Your vehicle's settings may affect its ability to pair with your smartphone:

- Charge Model X: If the vehicle Battery is too low, you may lose Bluetooth function.
- Update vehicle software and make sure it is always up to date. Check for new software updates by navigating to **Controls > Software**.
- Restart the touchscreen. See [Touchscreen on page 6](#).
- Reboot your vehicle.

If Bluetooth still does not work, unpair from your vehicle AND smartphone. Then try re-pairing both again.

For BLE phone key issues, when in the vehicle, navigate to **Controls > Locks** and remove your phone as "Phone as Key". Then set it back up again. But only do this while you are in the vehicle and have a reliable back up key available (such as a key card).



Using the Phone App



When your phone is connected to Model X using Bluetooth (see [Bluetooth on page 69](#)), and you have allowed access to information on your phone (see [Importing Contacts and Recent Calls on page 69](#)), you can use the phone app to display and make a hands-free call to anyone listed on your phone.

- **Calls:** Displays recent calls in chronological order with the most recent call listed first.
- **Messages:** Displays message in chronological order with the most recent message listed first. You can view, send, and receive text messages. Instead of typing a text message, touch the microphone button on the right side of the steering wheel to enter text using your voice.



WARNING: To minimize distraction and ensure the safety of occupants as well as other road users, do not view or send text messages when the vehicle is in motion. Pay attention to road and traffic conditions at all times when driving.

- **Contacts:** Contacts are listed in alphabetical order and can be sorted by first name or last name. You can also choose a letter on the right side of the list to quickly scroll to the names that begin with the selected character. When you touch a name on your contacts list, the contact's available number(s) displays on the right pane, along with other available information (such as address). Touch the contact's number to make a call.
- **Favorites:** Displays the contacts from your phone that you have identified as Favorites.
- **Calendar:** Displays calendar entries from your phone (see [Calendar on page 71](#)). If an entry includes a phone number or an address, you can make a phone call, or navigate to a destination, by touching the corresponding information in the calendar entry.

Making a Phone Call

You can make a phone call by:

- Speaking a voice command (see [Voice Commands on page 17](#)). Voice commands are a convenient, hands-free way to call or text your contacts.
- Selecting a contact or recent call from the menu on your right scroll button (see [Using Right Steering Wheel Buttons on page 78](#)).
- Touching a phone number shown in a list in the phone app - Contacts, Calls, or Calendar.
- Using the Model X on-screen dialer in the Phone app.

NOTE: If it is safe and legal to do so, you can also initiate a call by dialing the number or selecting the contact directly from your phone.

NOTE: You can also make a phone call by touching a pin on the map and choosing the phone number (if available) on the popup screen.

Receiving a Phone Call

When your phone receives an incoming call, the instrument panel and touchscreen display the caller's number or name (if the caller is in your phone's contact list and Model X has access to your contacts).

Touch one of the options on the touchscreen to **Answer** or **Ignore** the call. Depending on the phone you are using and what speakers you used for your most recent call, your phone may prompt you to choose which speakers you want to use for the incoming call.



WARNING: Stay focused on the road at all times while driving. Using or programming a phone while driving, even with Bluetooth enabled, can result in serious injury or death.



WARNING: Follow all applicable laws regarding the use of phones while driving, including, but not limited to, laws that prohibit texting and require hands-free operation at all times.

In Call Options

When a call is in progress, you can display the call menu on the instrument panel by pressing the top button on the right side of the steering wheel. Then roll the right scroll button and choose an option (see [Using Right Steering Wheel Buttons on page 78](#)). To adjust the call volume, roll the steering wheel's left scroll button during a call.

Calendar



The calendar displays scheduled events from your phone's (iPhone® or Android™) calendar for the current and next day. The calendar is conveniently integrated with the phone app so you can dial into your meeting from a Calendar entry. It is also integrated with the navigation system so you can navigate to the event's location.

1. Ensure your phone is paired to Model X.
2. Ensure you are logged into the Tesla mobile app.
3. In your Tesla mobile app, touch **Profile > Settings > Calendar Sync**.

NOTE: To ensure you have access to all of the calendar's features, it is recommended that you use the most recent version of the mobile app.

4. On your phone, go to **Settings** and allow access/give permission to share your calendar with the Tesla mobile app. The mobile app can then periodically (and automatically) send calendar data from your phone to Model X.



Phone, Calendar, and Web Conferencing

If a calendar event includes an address, a navigation arrow displays to indicate that you can touch the address to navigate to the event's location.

If an event has a uniquely specified address and takes place within two hours of you entering your vehicle and preparing to drive, Model X automatically routes you to the event's address (see [Automatic Navigation on page 160](#)).

Touch an event's information icon to display all notes associated with the event. If the notes include one or more phone numbers, the information icon shows a phone icon and the calendar displays the first phone number found. Touch to initiate a phone call. You can also initiate a phone call by touching any number in an event's notes popup screen (this is especially useful for conference calls). If notes include a web link, you can touch the link to open it in the Web browser.

HomeLink Universal Transceiver



If your vehicle is equipped with the HomeLink® Universal Transceiver, you can operate up to three Radio Frequency (RF) devices, including garage doors, gates, lights, and security systems.

NOTE: Depending on date of manufacture, market region, and options selected at time of purchase, some vehicles are not equipped with a HomeLink Universal Transceiver.

WARNING: Do not use the HomeLink Universal Transceiver with a device that does not have safety stop and reverse features. Using a device without these safety features increases the risk of injury or death.

Supported Modes

HomeLink supports three different transmit modes, which is how your vehicle and the RF device communicate. Selecting a transmit mode is determined by your RF device's compatibility:

- **Standard Mode:** Use Standard Mode if your RF device is equipped with a remote control that must be used to operate the device (for example, a remote-controlled garage door). This mode is the most commonly used transmit mode for HomeLink devices.
- **D-Mode or UR-Mode:** Use D-Mode or UR-Mode if the RF device does not have a remote control, and the receiver has a "Learn" button (may also be called "Program" or "Smart"). D-Mode and UR-Mode function similarly in that Model X communicates directly with the device's receiver as opposed to the remote control.

NOTE: D-Mode is used primarily in North America whereas UR-Mode is popular in Europe, the Middle East, and Asia. To determine the mode your device is compatible with, contact HomeLink by going to www.homelink.com.

Each of your devices can be set to a different mode. For example, your garage door can be set to Standard Mode, your front gate can be set to D-Mode, etc. To change a transmit mode, touch the HomeLink icon at the top of the touchscreen and select the device you want to change. Then, select **Program** and choose the desired mode for your device. Confirm by touching **Set Mode** and follow the onscreen instructions.

For older vehicles, changing the mode for one device changes the mode for all devices, so be careful when changing transmit modes. Devices not compatible with your selected mode may not work. Touch the HomeLink icon at the top of the touchscreen, then touch **Change Transmit Mode**.

NOTE: Check the product information for your HomeLink device to determine which mode is compatible with your device.

Programming HomeLink

To program HomeLink®:

1. Park Model X so that the front bumper is in front of the device you want to program.

CAUTION: Your device might open or close during programming. Therefore, before programming, make sure that the device is clear of any people or objects.

2. Check that the device's remote control has a healthy battery. Tesla recommends replacing the battery in the device's remote control before Programming HomeLink.
3. Touch the HomeLink icon at the top of the touchscreen.
4. Touch **Create HomeLink**.
5. On the HomeLink screen, enter a name for the device, then touch **Enter** or **Add New HomeLink**.
6. Choose the mode you wish to use (Standard, D-Mode, or UR-Mode), then touch **Set Mode**.
7. Touch **Start** and follow the onscreen instructions.

NOTE: If you see a screen called "Train the receiver" while programming the device, remember that this is a time-sensitive step. After pressing the Learn/Program/Smart button on the device's remote control, you have only approximately 30 seconds to return to your vehicle and press **Continue**, and then press the trained HomeLink device name twice. Consider having an assistant to ensure you can complete this step within 30 seconds.

8. Once your device is programmed, touch **Save** to complete the programming.
9. Ensure HomeLink works as expected. In some cases, you may need to repeat the programming process multiple times before succeeding.

Once programmed, you can operate the device by touching its corresponding HomeLink icon on the touchscreen. HomeLink remembers the location of your programmed devices. When you approach a known location, the HomeLink control on the touchscreen automatically appears. When you drive away, it disappears.

NOTE: For additional assistance or compatibility questions, contact HomeLink (www.homelink.com or call 1-800-355-3515).

Auto Opening and Closing

To operate a HomeLink device without using the touchscreen, you can automate the device to open as you approach, and close as you drive away:

1. Touch the HomeLink icon at the top of the touchscreen, touch **HomeLink Settings**, then choose the device you want to automate.
2. Adjust the device's HomeLink settings as needed:



- Select the **Auto-open when arriving** checkbox if you want the device to open as you approach.
- Touch the arrows to specify the distance you want Model X to be from the device before it opens.
- Select the **Auto-close when leaving** checkbox if you want the device to close as you drive away.
- Select the **Auto-fold mirrors** checkbox if you want mirrors to fold when you arrive at the HomeLink location. This is useful for narrow garages.
- Select the **Chime for Auto-open and Auto-close** checkbox if you want Model X to sound a chime when a signal has been sent to open or close the device.

HomeLink remembers the vehicle's GPS location at the time of pairing and uses this to determine the vehicle's whereabouts in relation to the HomeLink device. HomeLink does not detect and differentiate between opening and closing (ex: if Auto-open is triggered and the door is already open, the door will close) but typically determines whether to auto-open or -close based on the following:

Auto-Open: Detects when Model X approaches the garage door (or other HomeLink device) within a specified distance. Auto-open initiates so long as the approaching vehicle is in Drive and HomeLink is enabled. HomeLink does not trigger when the vehicle is already in the area.

Auto-Close: HomeLink triggers when the Model X shifts from Park into Reverse, and moves at least seven meters in Reverse.

NOTE: Changing gears multiple times while in the specified distance may interfere with Auto-close.

In situations where you don't want the device to automatically open or close, touch **Skip Auto-Open** or **Skip Auto-Close** at any time during the count-down message.

NOTE: Do not rely on HomeLink to ensure the device fully closes.

Resetting the Location of the HomeLink Device

If you experience situations in which you sometimes drive up to your HomeLink device and it doesn't open, or the touchscreen does not display a notification as you approach a programmed device, you may need to reset the device's location. To do so, park as close as possible to the HomeLink device (garage door, gate, etc.) and display the HomeLink settings page by touching the HomeLink icon at the top of the touchscreen. Touch the name of the device you want to reset, then touch **Reset Location**.

Deleting a Device

To delete a HomeLink device, touch the HomeLink icon at the top of the touchscreen, then touch **HomeLink Settings**. Touch the name of the device you want to delete, then touch **Delete**.

NOTE: You can also perform a factory reset to erase your HomeLink settings, along with all other personal data (saved addresses, music favorites, imported contacts, etc.). See [Erasing Personal Data with a Factory Reset on page 9](#).

NOTE: For security reasons, delete your HomeLink devices if you sell your Model X.

Troubleshooting HomeLink

Standard Mode

In Standard Mode, Model X records the RF signal from your HomeLink device's remote control. The touchscreen instructs you to stand in front of the vehicle, point the device's remote control at the front bumper, and press and hold the button until the headlights flash. When the headlights flash, Model X has learned the remote control and you can touch **Continue** on the touchscreen. If the headlights do not flash:

- Check the batteries in the remote control. It is a good idea to replace the batteries before you start programming.
 - Ensure you are standing in front of Model X with the device's remote control positioned within five cm of the Tesla emblem.
 - Press and hold the button on your device's remote control until the headlights flash. In some cases you must hold the button on the remote control for up to three minutes.
- NOTE:** Some HomeLink remote controls require multiple short presses (approximately one second each press) instead of one long duration press. If you are unsuccessful after multiple attempts of using long presses, try repeated presses of one second each.

D-Mode and UR-Mode

In D-Mode and UR-Mode, the device's receiver learns Model X. The touchscreen instructs you to press the "Learn" button (may also be called "Program" or "Smart") on the device's receiver. If this does not work, refer to the following guidelines:

- Park Model X with its bumper as close as possible to the garage door, gate, etc. that you are trying to program.
- Make sure you are pressing the receiver's Learn/Program/Smart button. For instructions on how to put the receiver into learning mode, refer to the product details provided with your RF device that you are trying to program.
- If you see a screen called "Train the receiver" while programming the device, remember that this is a time-sensitive step. After pressing the Learn/Program/Smart button on the device's remote control or receiver, you only have approximately 30 seconds to return to your vehicle, press **Continue**, then press the trained HomeLink device name twice. Consider having someone assist you with this step.

- Most devices stay in learning mode for only three to five minutes. Immediately after pressing the device's Learn/Program/Smart button, follow the instructions displayed on the vehicle's touchscreen.

For additional assistance or compatibility questions, contact HomeLink (www.homelink.com or call 1-800-355-3515).



Starting and Powering Off

Starting

When you open a door to enter Model X, the instrument panel and touchscreen power on and you can operate all controls. To drive Model X:

1. **Press the brake pedal** - Model X powers on and is ready to drive.
2. **Select a drive mode** - move the drive stalk down for Drive or up for Reverse (see [Shifting on page 82](#)).

NOTE: If the **PIN to Drive** feature is enabled (see [PIN to Drive on page 143](#)), you must also enter a valid PIN on the touchscreen before you can drive Model X.

Everything you need to know when driving Model X displays on the instrument panel.

Key Fob Not Inside

If Model X does not detect a key fob when you press the brake, the instrument panel displays a message telling you that a key fob is not inside.

If you receive this message, press the brake and place the key fob in the center console cup holder where Model X can best detect it.

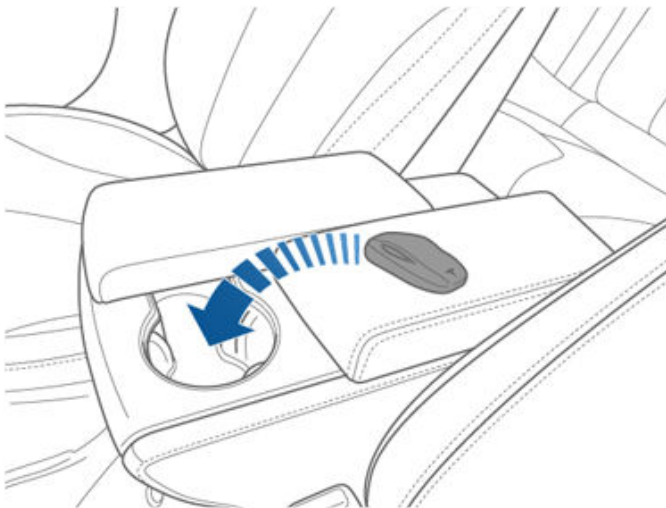

If Model X still does not detect the key fob, try holding it against the center console, immediately below the low voltage power socket (see [Low Voltage Power Socket on page 10](#)). If the key fob is still not detected, remove the key fob's battery and try again. See [Replacing the Key Fob Battery on page 21](#). Or try using another key fob. If another key fob does not work, contact Tesla.

A number of factors can affect whether Model X can detect the key fob. These include a low battery in the key fob, interference from other devices using radio signals, and objects between the key fob and receiver.

Always keep the key fob with you. After driving, the key fob is needed to restart Model X after it powers off. And when you leave Model X, you must bring the key fob with you to lock Model X, either manually or automatically.

Powering Off

When you finish driving, shift into Park by pressing the button on the end of the drive stalk. When you leave Model X with the key fob, it powers off automatically, turning off the instrument panel and touchscreen.

Model X also powers off automatically after being in Park for 30 minutes, even if you are sitting in the driver's seat.

Although usually not needed, you can power off Model X while sitting in the driver's seat, provided the vehicle is not moving. Touch **Controls > Safety > Power Off**. Model X automatically powers back on again if you press the brake pedal or touch the touchscreen.

NOTE: Model X automatically shifts into Park whenever it determines that you are exiting the vehicle (for example, the driver's seat belt is unbuckled and the vehicle is almost at a standstill). If you shift into Neutral, Model X shifts into Park when you open the door to exit. To keep Model X in Neutral, see [Instructions for Transporters on page 212](#).

Power Cycling the Vehicle

You can power cycle Model X if it demonstrates unusual behavior or displays a nondescript alert.

NOTE: If the touchscreen is unresponsive or demonstrates unusual behavior, reboot it before you power cycle the vehicle (see [Restarting the Touchscreen or Instrument Panel on page 8](#)).

1. Shift into Park.
2. On the touchscreen, touch **Controls > Safety > Power Off**.
3. Wait for at least two minutes without interacting with the vehicle. Do not open the doors, touch the brake pedal, touch the touchscreen, etc.
4. After two minutes, press the brake pedal or open the door to wake the vehicle.



Adjusting Steering Wheel Position

Adjust the steering wheel to the desired driving position by moving the control on the left side of the steering column. Using this control, you can move the steering wheel forward and backward and up and down.

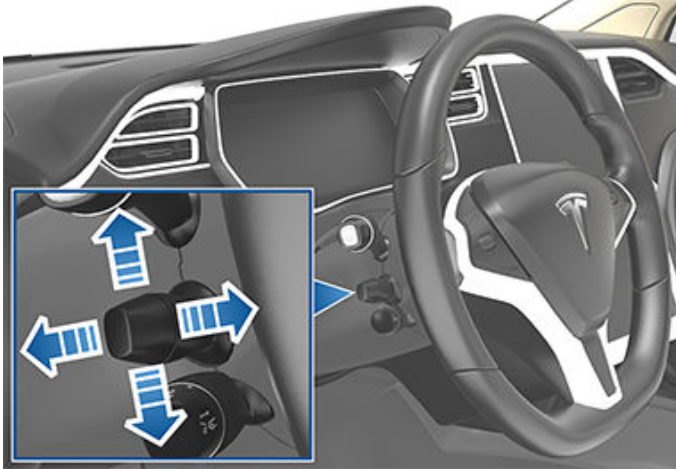

WARNING: Do not make adjustments while driving.

Adjusting Steering Weight

You can adjust the feel and sensitivity of the steering system to suit your personal preference:

1. On the touchscreen, touch **Controls > Pedals & Steering > Steering Weight**.
2. Choose a steering option:
 - **Light** - Reduces the effort required to turn the steering wheel. In town, Model X feels easier to drive and park.
 - **Standard** - Tesla believes that this setting offers the best handling and response in most conditions.
 - **Heavy** - Increases the effort required to turn the steering wheel. When driving at higher speeds, Model X feels more responsive.

Using Left Steering Wheel Buttons

Use the buttons on the left side of the steering wheel to change radio stations, control media player volume, and to choose what displays on the left side of the instrument panel (whenever the Navigation app is not displaying instructions).

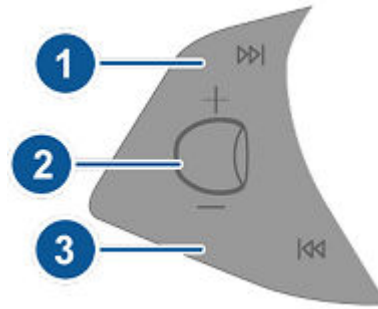

1. Next

If you are listening to local or satellite radio and you have defined more than one radio preset, press to play the next preset in the radio band that is currently playing. If you have not defined more than one preset, press to go to the next available frequency.

If you are listening to Internet radio, or to an audio file on a connected Bluetooth or USB device, press to skip to the next song or station.

If you have more than one favorite defined, press and hold to cycle through favorites.

2. Scroll Button

- To adjust the media volume, roll up or down.

NOTE: The scroll button adjusts the volume for media, navigation instructions and phone calls based on what is currently in use. As you adjust volume, the instrument panel displays the volume level and whether you are adjusting volume for media, navigation or phone.

- To mute the media volume, or to pause/play an audio file, tap the scroll button.
- To choose what displays on the left side of the instrument panel, hold the scroll button briefly until the available options are displayed. Roll the scroll button to choose **Empty, Car Status, Clock, Media, Energy, Trips, Suspension**, etc. When the option you want is highlighted, tap the scroll button.

NOTE: The option you choose to display using the left scroll button is retained until you manually change it.

NOTE: Car status displays information such as status of doors and trunks, and on newer model vehicles, the tire pressure measurements.

3. Previous

Same as described above for Next, except it skips to the previous song or station. If you have more than one favorite defined, press and hold to cycle through favorites.



Steering Wheel

NOTE: Regardless of how you customize the left side of the instrument panel, it automatically changes to display navigation instructions (if applicable), or to let you know if a door or trunk is open when Model X is in Drive or Reverse.

Using Right Steering Wheel Buttons

Use the buttons on the right side of the steering wheel to access call options while on a phone call, to choose what displays on the right side of the instrument panel, to adjust Model X features, and to use voice commands.

NOTE: Whenever you receive or make a phone call, the right side of the instrument panel automatically displays call options to help you easily handle phone calls on your Bluetooth-connected phone.

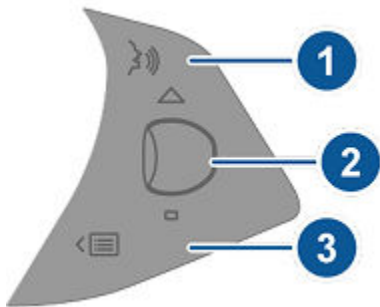

1. Press to use a voice command to call a contact, navigate, or listen to Internet music. When you hear the tone, speak your command. For details, see [Voice Commands on page 17](#).

2. Scroll Button

- During a phone call, touch the scroll button to display call options that allow you to perform an action on the call.
- Roll the scroll button to adjust the most recently used feature from the feature list (see Menu button).
- To choose what displays on the right side of the instrument panel, hold the scroll button briefly until the available options are displayed. Roll the scroll button to choose **Empty**, **Car Status**, **Clock**, **Media**, **Energy**, **Trips**, **Suspension**, etc. When the option you want is highlighted, tap the scroll button.

NOTE: Car status displays information such as status of doors and trunks, and on newer model vehicles, the tire pressure measurements.

NOTE: The option you choose to display using the right scroll button is retained until you manually change it.

- To restart the touchscreen, hold down both scroll buttons for approximately five seconds. See [Restarting the Touchscreen or Instrument Panel on page 8](#).

- **Suspension.** Display a real-time visualization of how the suspension system is dynamically adjusting each wheel's damping to account for changing road conditions. Roll the scroll button to choose Suspension and then press the scroll button. See [Air Suspension on page 90](#).

3. Menu button

Press to display a menu that allows you to control the following Model X:

- **Temperature.** Roll the scroll button to change the driver side temperature, or press the wheel to turn the climate control system on and off.
- **Fan Speed.** Roll the scroll button to adjust the speed of the fan used to cool or heat the cabin.
- **Display Brightness.** Roll the scroll button to change the brightness level of the displays, or press the wheel to restore default settings.
- **Recent Calls.** If your phone is paired to Model X, roll the scroll button to view your recent calls. Press the scroll button to call the contact that's displayed. To pair your phone, see [Pairing a Phone or Bluetooth Device on page 69](#).
- **Contacts.** If your phone is paired to Model X, roll the scroll button to navigate to contacts in your phone. Your contacts are listed alphabetically by their last name. To ensure Model X can access your contacts, see [Importing Contacts and Recent Calls on page 69](#).

Press the menu button again to close the feature list.

Heated Steering Wheel

If Model X is equipped with the cold weather package, you can warm up the steering wheel by touching climate controls on the touchscreen (see [Operating Climate Controls on page 149](#)). When turned on, radiant heat keeps the steering wheel at a comfortable temperature.

Horn

To sound the horn, press and hold the center pad on the steering wheel.





Mirrors

Adjusting Exterior Mirrors

Press the button associated with the mirror you want to adjust (left or right). The button's light turns on and you can then press the dial to move the mirror to the desired position. Repeat for the other side mirror. If prompted, touch **Save** on the touchscreen to save the mirror adjustment in your driver profile.



When you manually fold the mirrors, they remain folded until your driving speed reaches 50 km/h (or until you manually unfold them).

NOTE: You cannot fold a mirror when driving over 50 km/h.

To set the mirrors to fold automatically whenever you exit and lock Model X touch **Controls > Vehicle > Mirror Auto-Fold**. The mirrors unfold automatically when you unlock Model X.

You can also set the mirrors to fold automatically whenever you arrive at a specific location, which saves you from having to manually fold them each time you arrive at a frequented place. To set this up, Model X must be driving at a low speed (less than 3 mph/5 km/h) or stopped at the location you want your vehicle to remember. Then touch **Controls > Always Fold Mirrors at this Location**. Next time you approach the saved location, your mirrors fold and unfold within 25 feet (7.5 meters) of the location. To stop the mirrors from folding at a saved location, drive to the saved location and touch the **X** next to **Auto-Fold Set at This Location**.

NOTE: When you leave the saved location, mirrors can unfold when your driving speed is over 5 km/h, or until you touch **Controls > Unfold Mirrors**.

NOTE: Mirrors can automatically fold if you return to a saved location and are driving below 50 km/h.

NOTE: You can override the automatic folding/unfolding of mirrors at any time (for example, Model X has no power) by pushing the mirror assembly away from you to unfold, or pulling it toward you to fold.

You can integrate auto-folding mirrors with HomeLink (see [Smart Garage on page 73](#)). To enable, go to **HomeLink > Auto-Fold Mirrors when Nearby**.

Auto-Tilt automatically tilts mirrors downward when reversing. To turn Auto-Tilt on or off, touch **Controls > Vehicle > Mirror Auto-Tilt**. To adjust the auto-tilt position, make mirror adjustments with Model X shifted into Reverse. When you shift out of Reverse, mirrors tilt back to their normal (upward) position. But now that you have adjusted them for reversing, they automatically tilt to the selected downward position whenever you shift into Reverse.

The driver's side mirror automatically dims at night, in proportion to the level of glare from the headlights of a vehicle behind you (except when in Reverse). Also, both exterior side mirrors have heaters that turn on and off with the rear window defroster.

NOTE: See [Cold Weather Best Practices on page 155](#) for information to ensure your mirrors function properly in cold weather.

Folding Mirrors

To manually fold and unfold exterior mirrors (for example, parking in a narrow garage, tight space, etc.), press the center button. You can also manually fold and unfold mirrors by touching **Controls > Fold/Unfold**.

Interior Mirrors

Rear View Mirror

Adjust the rear view mirror manually. When in Drive or Neutral, the rear view mirror automatically dims in low lighting conditions based on the time of day (for example, when driving at night).

Vanity Mirrors

See [Sun Visors on page 29](#) for details on how to expose and illuminate the vanity mirrors.



Shifting

How to Shift

When Model X is in Park, you must press the brake pedal to shift.

Move the drive stalk up or down to shift into different drive modes. A chime sounds whenever you shift gears.

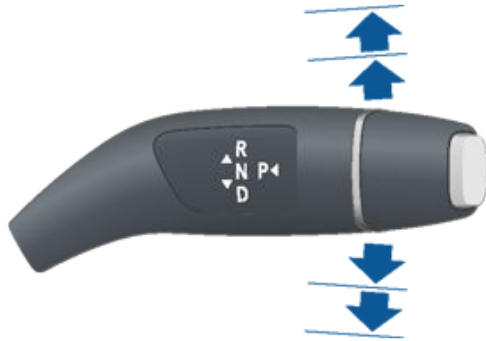

If you try to shift when it is prohibited by the current driving speed, a chime sounds and the drive mode does not change.

If you want to disable chime sounds when you shift gears, touch **Controls > Safety > Gear Chimes**.

Reverse

Push the drive stalk all the way up and release. You can only shift into Reverse when Model X is stopped or moving less than 8 km/h.

Neutral

Neutral allows Model X to roll freely when you are not pressing the brake pedal:

- When in Park, shift into Neutral by briefly pushing the drive stalk either up or down to the first position.
- When in Drive, shift into Neutral by briefly pushing the drive stalk up to the first position. If Autosteer or Traffic-Aware Cruise Control (if equipped) is active, you must push the drive stalk up to the first position and hold it there for more than 1 second. In doing so, Autosteer or Traffic-Aware Cruise Control is disabled.
- When in Reverse, shift into Neutral by briefly pushing the drive stalk down to the first position.

NOTE: You must press the brake pedal to shift out of Neutral if driving slower than approximately 8 km/h.

If Model X is in Park and you use the touchscreen to release the parking brake (**Controls > Safety > Parking Brake**), Model X shifts into Neutral (see [Parking Brake on page 88](#)).

Drive

Push the drive stalk all the way down and release. You can shift into Drive when Model X is stopped or moving less than 8 km/h in Reverse.

Park

Press the end of the drive stalk while Model X is stopped.



Model X automatically shifts into Park to prevent roll-away while driving in low speeds. This happens whenever you connect a charge cable, unbuckle your seat belt, or open the door while in Drive or Neutral. Ensure the charge cable is removed, buckle your seat belt, and close the door before shifting out of Park.

To make it convenient to pick up passengers, you can also unlock all doors at any time by shifting into Park then pressing the Park button a second time.

NOTE: You must press the brake pedal to shift out of Park.

NOTE: The above conditions do not reflect a comprehensive list of reasons why Model X may or may not automatically shift into Park and, in certain scenarios, it is possible for your vehicle to shift into Park when only one of the above conditions is true.



CAUTION: In emergency situations, if the brakes are not functioning properly, press and hold the Park button on the drive stalk to bring Model X to a stop. Do not use this method to stop the vehicle unless absolutely necessary.



WARNING: It is the driver's responsibility to always ensure the vehicle is in Park before exiting. Never rely on Model X to automatically shift into Park for you; it might not work in all circumstances (for example, if Creep or a slope causes the vehicle to travel greater than approximately 2 km/h).

Controlling Lights



Touch **Controls** > **Lights** to control the lights.

In addition to the lights that you can control from the touchscreen, Model X has convenience lights that turn on and off automatically based on what you are doing. For example, interior lights, marker lights, tail lights, and puddle lights turn on when you unlock Model X, when you open a door, and when you shift into Park. They turn off automatically after a minute or two or when you shift or lock Model X.

Exterior Lights

Exterior lights (headlights, tail lights, side marker lights, parking lights, and license plate lights) are set to **Auto** each time you start Model X. If you change to a different setting, lights always revert to **Auto** on your next drive.

Touch one of these options to change and retain the exterior light setting until adjusted again or the next time you drive:

OFF Exterior lights turn off. When driving, daytime running lights may remain on based on regulations in various market regions.



Parking lights, side marker lights, tail lights and license plate lights turn on.



Low beam headlights, side marker lights, parking lights, tail lights, and license plate lights turn on.

CAUTION: Ensure the headlights and rear lights are on during low visibility conditions (for example, when it is dark, foggy, snowy, or the road is wet, etc.). The rear tail lights are off while daytime running lights are on. Failure to do so can cause damage or serious injury.

NOTE: To comply with local traffic regulations when crossing from a left-hand traffic region to a right-hand traffic region, and vice versa, headlights should be adjusted. If you plan to drive to a region that requires headlights to be adjusted, schedule a service appointment using the mobile app.

Fog Lights

If equipped, touch to turn the fog lights on or off. Fog lights operate only when low beam headlights are on. When headlights are turned off, fog lights also turn off.



The rear fog indicator displays on the instrument panel whenever rear fog lights (if equipped) are on.



The front fog indicator displays on the instrument panel whenever the optional front fog lights are on.

NOTE: Depending on the market region and vehicle options, your vehicle may not be equipped with front and/or rear fog lights.

NOTE: In some regions, there is no control for the front fog lights. They operate in conjunction with the headlights and turn on only in situations where low beam headlights are on.

Dome Lights

Turn the interior dome (map) lights on or off. If set to **Auto**, all interior dome lights turn on when you unlock Model X, open a door upon exiting, or shift into Park.

You can also manually turn an individual dome light on or off by touching its lens. If you turn a dome light on, it turns off when Model X powers off. If Model X was already powered off when you manually turned the light on, it turns off after 60 minutes.

Headlights after Exit

When you stop driving and park Model X in low lighting conditions, exterior lights temporarily remain illuminated. They automatically turn off after one minute or when you lock Model X whichever comes first.

NOTE: If you lock Model X using the Tesla mobile app or key fob, the headlights immediately turn off. However, if the vehicle locks because Walk-Away Door Lock is enabled (see [Walk-Away Door Lock on page 26](#)), the headlights automatically turn off after one minute.

To turn this feature on and off, touch **Controls** > **Lights** > **Headlights After Exit**. When **Headlights After Exit** is off, the headlights turn off immediately when you engage Park and open a door.

High Beam Headlights

Push the turn signal stalk away from you to turn the high beam headlights on continuously. To cancel, pull the stalk towards you.

To briefly flash the high beam headlights, pull the stalk towards you.



Lights



The high beam headlights can automatically switch to low beam when there is light detected in front of Model X (for example, from an oncoming vehicle). To turn this feature on or off, touch **Controls > Auto High Beam** or **Controls > Lights > Auto High Beam**.

NOTE: Your chosen setting is retained until you manually change it.

NOTE: Auto High Beam is available only on vehicles equipped with Autopilot components.

NOTE: **Auto High Beam** is automatically enabled when Autosteer is engaged.

In situations where high beams are turned off because **Auto High Beam** is turned on and light is detected in front of Model X, you can temporarily turn on high beams by pulling the stalk all the way toward you.

The following indicator lights are visible on the instrument panel to show the status of the headlights:

 Low beam headlights are on.

 High beam headlights are on. Illuminates when high beams are on but the **Auto High Beam** setting is turned off or if the **Auto High Beam** setting is turned on but is temporarily unavailable.

 High beams are currently turned on, and **Auto High Beam** is ready to turn off the high beams if light is detected in front of Model X.

 High beams are temporarily turned off because **Auto High Beam** is operating and light is detected in front of Model X. When light is no longer detected, high beam headlights automatically turn back on.

 **WARNING:** **Auto High Beam** is a convenience only and is subject to limitations. It is the driver's responsibility to make sure that headlights are always appropriately adjusted for weather conditions and driving circumstances.

Turn Signals

Move the turn signal stalk up (before turning right) or down (before turning left). The turn signals flash three times or continuously, depending on how far up or down you move the stalk. Lightly push the stalk up or down for a three-flash sequence. For a continuous signal, push the stalk fully up or down.



The turn signals stop operating when canceled by the steering wheel, or when you return the stalk to the central position.

 When a turn signal is operating, the corresponding turn signal indicator lights up on the instrument panel and a clicking sound can be heard.

 **WARNING:** When actively using Traffic-Aware Cruise Control (if equipped), engaging a turn signal can cause Model X to accelerate in specific situations (see [Overtake Acceleration on page 121](#)).

 **WARNING:** When actively using Autosteer (if equipped), engaging a turn signal can cause Model X to change lanes (see [#unique_252 on page](#)).

Hazard Warning Flashers

To turn on the hazard warning flashers, press the button located on the side of the touchscreen closest to the steering wheel. All turn signals flash. Press again to turn off.

NOTE: Hazard warning flashers operate even without a key nearby.

Condensation in Head or Tail Lights

Due to weather changes, humidity levels, or recent exposure to water (such as a car wash), condensation may occasionally accumulate in your vehicle's head or tail lights. This is normal — as the weather gets warmer and humidity decreases, condensation often disappears on its own. If you notice water buildup within the exterior lenses, or if the condensation affects the visibility of the exterior lights, contact Tesla Service.



Wipers

To wipe the windshield, rotate the end of the turn signal stalk away from you. You can rotate to five positions:

- 1st: Off.
- 2nd: Auto with low rain sensitivity.*
- 3rd: Auto with high rain sensitivity.*
- 4th: Continuous, slow.
- 5th: Continuous, fast.



For a single wipe, press and release the end of the stalk.

If the wipers are set to Auto and Model X detects no liquid on the windshield, the wipers do not wipe.

*To enable the **Auto** settings, touch **Controls > Vehicle > Autowipers (Beta)**. When wipers are set to Auto, Model X detects whether or not it is raining. The frequency at which they wipe depends on how much rain is detected on the windshield. When wipers are set to high rain sensitivity, the wipers turn on when Model X detects a light mist.

NOTE: The Auto setting is currently in BETA. If uncertain about using the Auto setting while in the BETA phase, Tesla recommends operating the wipers manually, as necessary.

NOTE: You can also adjust the windshield wiper speed and frequency using voice commands (see [Voice Commands on page 17](#)).

CAUTION: Ensure the wipers are in the Off position before washing Model X to avoid the risk of damaging the wipers.

To extend the life of wiper blades, remove ice from the windshield before turning wipers on. Ice has sharp edges that can damage the rubber on the wiper blades.

Periodically check and clean the edge of the wiper blade. If damaged, replace the wiper blade immediately. For details on checking and replacing wiper blades, see [Windshield Wiper Blades, Jets and Fluid on page 195](#).

CAUTION: In harsh climates, ensure that the wiper blades are not frozen or adhered to the windshield.

Defrosting Wipers

To make wiper blades easy to access so you can remove any ice and snow, shift Model X into Park, turn the wipers off, then use the touchscreen to move them to the service position. Touch **Controls > Service > Wiper Service Mode**. When parking in cold outdoor climates, it is helpful to leave Model X with the wipers in the service position. In this position, they are closer to the defrost vent, allowing you to thaw them by directing air from the climate control system towards the windshield.

If Model X is equipped with the optional cold weather package, you can defrost wipers by touching the climate control on the touchscreen (see [Operating Climate Controls on page 149](#)). Wiper defrosters automatically turn off after 15 minutes.

NOTE: Wipers automatically return to their normal position when you shift Model X out of Park.

Washers

Press the button on the end of the turn signal stalk to spray washer fluid onto the windshield. You can press this button at two levels. Press partially for a single wipe, without any washer fluid. Press fully for both wipe and wash. When washing the windshield, the wipers turn on. After releasing the button, the wipers perform two additional wipes then, depending on vehicle and environmental conditions, a third wipe a few seconds later.



s

Periodically top up washer fluid (see [Windshield Wiper Blades, Jets and Fluid on page 195](#)).



Braking and Stopping

Braking Systems

WARNING: Properly functioning braking systems are critical to ensure safety. If you experience a problem with the brake pedal, brake calipers, or any component of a Model X braking system, contact Tesla immediately.

Model X has an anti-lock braking system (ABS) that prevents the wheels from locking when you apply maximum brake pressure. This improves steering control during heavy braking in most road conditions.

During emergency braking conditions, the ABS constantly monitors the speed of each wheel and varies the brake pressure according to the grip available.

The alteration of brake pressure can be felt as a pulsing sensation through the brake pedal. This demonstrates that the ABS is operating and is not a cause for concern. Keep firm and steady pressure on the brake pedal while experiencing the pulsing.



The ABS indicator briefly flashes amber on the instrument panel when you first start Model X. If this indicator lights up at any other time, an ABS fault has occurred and the ABS is not operating. Contact Tesla. The braking system remains fully operational and is not affected by an ABS failure. However, braking distances may increase. Drive cautiously and avoid heavy braking.



If the instrument panel displays this red brake indicator at any time other than briefly when you first start Model X, a brake system fault is detected, or the level of the brake fluid is low. Contact Tesla immediately. Apply steady pressure and keep the brakes firm to bring the vehicle to a stop when safe to do so.



The instrument panel displays this amber brake indicator if a brake booster fault is detected or regenerative braking is unavailable (see [Regenerative Braking on page 87](#)). Apply steady pressure and keep the brakes firm to stop the vehicle when safety permits. Hydraulic Boost Compensation may be active (see [Hydraulic Boost Compensation on page 87](#)).

Emergency Braking

In an emergency, fully press the brake pedal and maintain firm pressure, even on low traction surfaces. The ABS varies the braking pressure to each wheel according to the amount of traction available. This prevents wheels from locking and ensures that you stop as safely as possible.

If an alternative method is needed to bring the vehicle to a stop, press and hold the Park button on the drive stalk to apply the brakes and remove drive torque while the button is held.

WARNING: Do not pump the brake pedal. Doing so interrupts operation of the ABS and can increase braking distance.

WARNING: Always maintain a safe distance from the vehicle in front of you and be aware of hazardous driving conditions. While the ABS can improve stopping distance, it cannot overcome the laws of physics. It also does not prevent the danger of hydroplaning (where a layer of water prevents direct contact between the tires and the road).

CAUTION: Automatic Emergency Braking (see [Collision Avoidance Assist on page 138](#)) may intervene to automatically brake in situations where a collision is considered imminent. Automatic Emergency Braking is not designed to prevent a collision. At best, it can minimize the impact of a frontal collision by attempting to reduce your driving speed. Depending on Automatic Emergency Braking to avoid a collision can result in serious injury or death.

CAUTION: In emergency situations, if the brakes are not functioning properly, press and hold the Park button on the drive stalk to bring Model X to a stop. Do not use this method to stop the vehicle unless absolutely necessary.

Dynamic Brake Lights (if equipped)

If you are driving over 50 km/h and brake forcefully (or if Automatic Emergency Braking engages), the brake lights flash quickly to warn other drivers that Model X is rapidly slowing down. If Model X stops completely, the hazard warning lights flash. Flashing continues until you press the accelerator or manually press the hazard lights button to turn them off (see).

NOTE: When towing a trailer (if applicable), the brake lights on the trailer also operate as described above, even when the trailer is not equipped with a separate braking system.

WARNING: When towing a trailer (if applicable), always increase your following distance. Sudden braking may result in skidding, jack-knifing, and loss of control.

Brake Disc Wiping

To ensure brakes remain responsive in cold and wet weather, Model X is equipped with brake disc wiping. When cold and wet weather is detected, this feature repeatedly applies an imperceptible amount of brake force to remove water from the surface of the brake discs.



Hydraulic Fade Compensation

Model X is equipped with hydraulic fade compensation. This assists in monitoring brake system pressure and ABS activity for instances of reduced brake performance. If reduced brake performance is detected (for example, as a result of brake fade, or cold or wet conditions), you may hear a sound, feel the brake pedal pull away from your foot, and notice a strong increase in braking. Brake as you normally would and continue to press the brake pedal without releasing or pumping the brakes.

CAUTION: In emergency situations, if the brakes are not functioning properly, press and hold the Park button on the drive stalk to bring Model X to a stop. Do not use this method to stop the vehicle unless absolutely necessary.

WARNING: Always maintain a safe driving distance from the vehicle in front of you and exercise caution when driving conditions are hazardous. Brake disc wiping and hydraulic fade compensation is not a substitute for adequately applying the brakes.

Hydraulic Boost Compensation

Model X is equipped with a brake booster that activates the brakes when the brake pedal is pressed. Hydraulic boost compensation provides mechanical assistance if the brake booster fails. If a brake booster failure is detected, the brake pedal feels stiffer to press and you may hear a sound when you press the brake pedal. Drive cautiously and maintain a safe distance from other road users—brake pedal responsiveness and braking performance may be degraded. Braking distances may increase.

Regenerative Braking

Whenever Model X is moving and your foot is off the accelerator, regenerative braking slows down the vehicle and feeds any surplus power back to the Battery. By anticipating your stops and reducing or removing pressure from the accelerator pedal to slow down, you can take advantage of regenerative braking to increase driving range.

The power meter on the Energy app displays real-time feedback on the amount of power being used. You can also display the power meter on either side of the instrument panel by choosing **Energy** using the scroll button on the steering wheel (see [Steering Wheel on page 77](#)). When energy is being gained by regenerative braking, the power meter displays a green area that represents the amount of power that is being fed back to the Battery.

The amount of power fed back to the Battery using regenerative braking can depend on the current state of the Battery. For example, regenerative braking may be limited if the Battery is cold or is already fully charged. When regenerative braking is limited, the power meter displays a dashed line to indicate the amount of deceleration power that is not being fed back to the Battery.



NOTE: If regenerative braking is aggressively slowing Model X (such as when your foot is completely off the accelerator pedal at highway speeds), the brake lights turn on to alert others that you are slowing down.

NOTE: Because Model X uses regenerative braking, the brake pads are typically used less frequently than those in traditional braking systems. To avoid the accumulation of rust and corrosion, Tesla recommends frequently pressing the brake pedal to apply the mechanical brakes and dry the brake pads and rotors.

WARNING: In snowy or icy conditions, Model X may experience loss of traction during regenerative braking, particularly when in the **Standard** setting and/or not using winter tires. Tesla recommends using the **Low** setting in snowy or icy conditions to help maintain vehicle stability.

To Set the Regenerative Braking Level

NOTE: The regenerative braking setting is not available on all vehicles.

You can use the touchscreen to change the level of regenerative braking:

1. Touch **Controls > Pedals & Steering > Regenerative Braking**.
2. Choose from two levels:
 - o **Standard:** Provides the maximum amount of regenerative braking. When you release the accelerator, Model X slows down.
 - o **Low:** Limits regenerative braking. When you release the accelerator, Model X takes longer to slow down and coasts farther than if set to "Standard".



Braking and Stopping

Stopping Mode

Regenerative braking decelerates Model X whenever you release the accelerator pedal when driving. You can choose what you want Model X to do once the driving speed has been reduced to a very low speed (almost at a stop) and both the accelerator pedal and brake pedal are released. While in Park, touch **Controls > Driving > Stopping Mode** and choose from these options:

- **CREEP:** When close to, or at, a complete stop, the motor continues to apply torque, moving Model X slowly forward (in Drive) or backwards (in Reverse), similar to a conventional vehicle with an automatic transmission. In some situations, such as on a steep hill or driveway, you may need to press the accelerator pedal to continue moving or to prevent Model X from moving in the opposite direction.

 **WARNING:** Never rely on CREEP to apply enough torque to prevent your vehicle from rolling down a hill. Always press the brake pedal to remain stopped or the accelerator pedal to proceed up the hill. Failure to do so can result in property damage and/or a collision.

- **HOLD:** Maximizes range and reduces brake wear by continuing to provide regenerative braking at speeds lower than with the Creep and Roll settings. When Model X stops, the brakes are automatically applied without you having to put your foot on the brake pedal. Whether stopped on a flat surface or a hill, Vehicle Hold keeps the brake applied, provided your foot remains off the accelerator and brake pedals. See [Vehicle Hold on page 94](#).

 **WARNING:** Never rely on HOLD to adequately decelerate or fully stop your vehicle. Many factors can contribute to a longer stopping distance, including downward slopes, the low regenerative braking setting, and reduced or limited regenerative braking (see [Regenerative Braking on page 87](#)). Always be prepared to use the brake pedal to adequately decelerate or stop.

- **ROLL:** When close to, or at, a complete stop, Model X becomes free rolling like a vehicle in Neutral. Therefore, if stopped on a slope, Model X will roll downward. The brake does not engage, and the motor does not apply torque (until the accelerator pedal is pressed).

NOTE: If you choose CREEP or ROLL, you can still use Vehicle Hold to apply the brakes. However, you will need to briefly press the brake pedal when the vehicle is stopped. See [Vehicle Hold on page 94](#).

NOTE: Your preferred Stopping Mode setting does not sync to your driver profile.

 **WARNING:** Press the brake pedal if Model X moves when unsafe to do so. It is your responsibility to stay alert and be in control of the vehicle at all times. Failure to do so can result in serious damage, injury, or death.

 **WARNING:** Do not rely on regenerative braking and your chosen Stopping Mode to keep you and your vehicle safe. Various factors such as driving with a heavy vehicle load, on a steep hill, or on wet or icy roads affect deceleration rate and the distance at which Model X will come to a stop. Drive attentively and always stay prepared to use the brake pedal to stop as appropriate based on traffic and road conditions.

 **WARNING:** Forward Collision Warning and Automatic Emergency Braking do not operate when driving at very low speeds (see [Collision Avoidance Assist on page 138](#)). Do not rely on these features to warn you, or to prevent or reduce the impact of a collision.

Parking Brake

To engage the parking brake, touch **Controls > Safety**, press the brake pedal and then touch **Park Brake**.



A red parking brake indicator lights up on the instrument panel when the parking brake is engaged.

The parking brake is released when the vehicle is shifted into another gear.

You can also engage the parking brake by pressing and holding the button on the end of the drive stalk while in Park.



If the parking brake experiences an electrical issue, the amber parking brake indicator lights up and a fault message displays on the instrument panel.

NOTE: The parking brake operates on the rear wheels only, and is independent of the pedal-operated brake system.

 **CAUTION:** In the unlikely event that Model X loses electrical power, you cannot access the touchscreen and are therefore unable to release the parking brake without first jump starting (see [Jump Starting on page 218](#)).

 **WARNING:** In snowy or icy conditions the rear wheels may not have sufficient traction to prevent Model X from sliding down a slope, particularly if not using winter tires. Avoid parking on hills in snowy or icy conditions. You are always responsible for parking safely.



⚠ WARNING: Your Model X may display an alert if the road is too steep to safely park on, or if the parking brakes are not properly engaged. These alerts are for guidance purposes only and are not a substitute for the driver's judgment of safe parking conditions, including specific road or weather conditions. Do not depend on these alerts to determine whether or not it is safe to park at any location. You are always responsible for parking safely.

Brake Wear

Model X brake pads are equipped with wear indicators. A wear indicator is a thin metal strip attached to the brake pad that squeals as it rubs against the rotor when the pad wears down. This squealing sound indicates that the brake pads have reached the end of their service life and require replacement. To replace the brake pads, contact Tesla Service.

Brakes must be periodically inspected visually by removing the tire and wheel. For detailed specifications and service limits for rotors and brake pads, see [Subsystems on page 206](#). Additionally, Tesla recommends cleaning and lubricating the brake calipers every year or 20,000 km if in an area where roads are salted during winter months.

⚠ WARNING: Neglecting to replace worn brake pads damages the braking system and can result in a braking hazard.



Air Suspension

NOTE: When Model X starts, you may hear the sound of the compressor as the air suspension system's reservoir fills with air.

Your Model X is equipped with Adaptive Air Suspension that offers superior ride quality and allows you to choose a softer or firmer ride based on your preference. When carrying loads, the system also maintains a level height between the front and rear. You can manually adjust the ride height to suit your circumstances (for example, you can raise Model X when you need extra ground clearance, such as when driving on a steep driveway or ramp, in deep snow, over large speed bumps, parking curbs, etc.).



If a fault is detected that reduces the performance of the adaptive air suspension system, a yellow indicator lights up on the instrument panel. If the problem persists, contact Tesla.



If a fault is detected that disables the adaptive air suspension system, a red indicator lights up on the instrument panel. Contact Tesla.

Adjusting Ride Height

CAUTION: Before adjusting the suspension height, ensure Model X is clear of all obstacles, above and below.

You can manually adjust the ride height by pressing the brake pedal and touching **Controls > Suspension** on the touchscreen. The ride height settings that are available depend on your driving speed and other conditions (for example, the suspension does not lower if a door is open). The touchscreen also displays the approximate ground clearance for each setting. Drag the slider to choose from these options:

- **Very High** - When set to **Very High**, the suspension automatically lowers to the default ride height*, which is **Standard or Low**, after driving approximately 30 meters or when driving speed reaches 24 km/h. To maintain the **Very High** setting for an unlimited distance until your driving speed reaches the speed threshold, touch **Persist until 24 km/h** in the setting for **Very High**.
- **High** - When set to **High**, the suspension automatically lowers to the default ride height*, which is **Standard or Low**, after driving approximately 30 meters or when driving speed reaches 56 km/h. To maintain the **High** setting for an unlimited distance until your driving speed reaches the speed threshold, touch **Persist until 56 km/h**.
- **Standard** - The **Standard** setting ensures optimum comfort and handling under all loading conditions.
- **Low** - Lowering the height can improve aerodynamics, make it easier to load or unload cargo and passengers, and improve handling.

- **Very Low** - This setting takes effect when you manually choose it. The suspension will revert to the default setting on your next drive, or when appropriate based on vehicle speed.

*If the **Default Ride Height to Low** setting is turned off, the ride height is adjusted between **Standard** and **Low** to balance ride comfort with handling and range. To optimize handling and range, turn on the **Default Ride Height to Low** setting.



CAUTION: Avoid driving aggressively (hard accelerations, sharp turns, etc.) when the suspension is set to **High** or **Very High**. Doing so can cause vibration and increase the possibility of damage.



CAUTION: Acceleration may be reduced when the suspension is set to **High** or **Very High**.

Adaptive Suspension Damping

The settings associated with **Adaptive Suspension Damping** provide real-time adjustments to the suspension system to optimize both ride and handling. Choose from:

- **Comfort** - Provides a gentler ride for a relaxed driving experience.
- **Auto** - Adjusts to a wide range of roads and driving styles, providing a fluid yet well controlled ride.
- **Sport** - Provides a firmer, more controlled ride that increases driver engagement and connection to the road.
- **Advanced** - Can be used to fine tune the suspension by dragging individual sliders that adjust **Ride Comfort** and **Handling**.

Touch **Show Suspension Data** to display detailed information about the dampers for each wheel, including ride height, compression and rebound values, and body accelerations.

NOTE: When Adaptive Suspension Damping is set to **Comfort** or **Auto**, the suspension may raise to improve ride comfort on rough roads..

Use Comfort Damping in Autopilot (if equipped) - By default, damping automatically sets to the **Comfort** setting when using Autopilot, and reverts back to your chosen setting when Autopilot is no longer in use. Turn this setting off to disable this feature.

Real-time Visualization

The image of your Model X on the Suspension screen provides a real-time visualization of the status of the air suspension system. In addition to visually showing changes to the ride height, it displays Compression and Rebound lines that reflect how the suspension system is controlling the dampers for each wheel based on your chosen settings and changing road conditions. Both are controlled simultaneously. Touch **Show Suspension Data** to display detailed information about the dampers for each wheel, including ride height, compression and rebound values, and body accelerations.



NOTE: The instrument panel can also display a real-time visualization of how the suspension system is dynamically adjusting each wheel's damping to account for changing road conditions. To view, hold the respective steering wheel scroll button briefly until the available options are displayed. Roll the scroll button to highlight **Suspension**, then tap the scroll button.

Auto-Raising Locations

Whenever you raise the suspension to **High** or **Very High**, the location is automatically saved. By saving the location, you do not need to manually raise the suspension every time you arrive at a frequently-used location where you have previously raised the suspension. When you return to the saved location, Model X raises the suspension and the instrument panel displays a message indicating that the suspension is being raised.

When saving locations, Model X also saves the **Persist until XX km/h** setting (if specified).

NOTE: When returning to a saved location and driving faster than the **High** and **Very High** suspension settings allow, the suspension does not raise until Model X slows down.

NOTE: After leaving a saved location, the suspension automatically lowers. However, it may not lower until Model X meets the speed and distance threshold at which the suspension lowers.

NOTE: If Model X reaches a saved location and the existing suspension setting is already higher than the level that has been saved for that location, the ride height is not adjusted.

To remove an auto-raising location

If you do not want the suspension to automatically raise at a location, touch to deselect **Always raise at this location** in the popup that appears when you arrive at a saved location.

Self-Leveling

Model X equipped with air suspension automatically self-levels, even when power is off. To prevent damage when jacking or lifting the vehicle, you must activate **Jack Mode** to disable self-leveling (press the brake pedal and touch **Controls** > **Service** > **Jack Mode**). For more details, see [Jack Mode on page 197](#).



Park Assist

Model X is designed to detect the presence of objects. When driving slowly (for example, when parking), the vehicle alerts you if an object is detected in close proximity of your Model X. The vehicle alerts you when objects are detected in front of Model X when you are in Drive, and behind Model X when you are in Reverse.

WARNING: You may not be alerted if Model X rolls freely in the opposite direction (for example, Park Assist does not display an alert if Model X rolls backwards down a hill while in Drive).

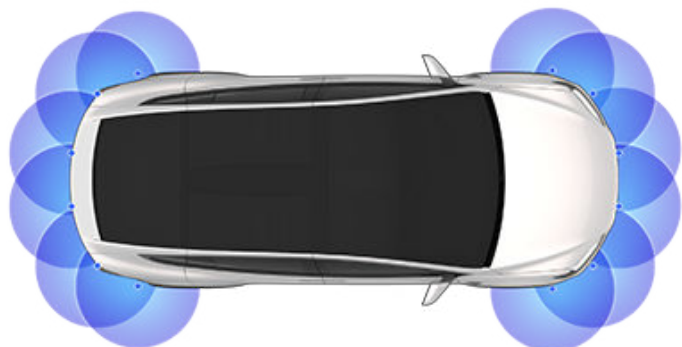

NOTE: Park Assist may be disabled when a bicycle is detected or Model X is in trailer mode.

WARNING: Never depend on Park Assist to inform you if an area you are approaching is free of objects and/or people. Several external factors can reduce the performance of Park Assist, causing either no readings or false readings (see [Limitations and False Warnings on page 93](#)). Therefore, depending on Park Assist to determine if Model X is approaching an obstruction can result in damage to the vehicle and/or objects, and can potentially cause serious injury. Always inspect the area with your own eyes. When reversing, perform shoulder checks and use all mirrors. Park assist does not detect children, pedestrians, bicyclists, animals, or objects that are moving, protruding, located too far above or below the cameras, or too close or too far from the cameras. Park Assist is for guidance purposes only and is not intended to replace your own direct visual checks. It is not a substitute for careful driving.

Visual and Audio Feedback

When you shift to Reverse, the Park Assist view displays on the left side of the instrument panel, showing objects that are in close proximity to the front and rear of Model X. This view closes when you shift into Drive unless an object is detected close to the front of Model X, in which case the Park Assist view closes automatically when you start driving faster than the speed at which Park Assist operates. When reversing, visual feedback also displays on the touchscreen (see [Rear Facing Camera\(s\) on page 101](#)). You can manually close the park assist view on the touchscreen by touching the **X**.

When driving at low speeds with the Camera app displayed on the touchscreen, you can switch to the Park Assist view by touching the button located in the upper left corner of the Camera app screen. This is useful if you need assistance with parallel parking.

If chimes are turned on (see [Controlling Audible Feedback on page 92](#)), an audible beep sounds as you approach an object. You can temporarily mute the chime by touching the speaker icon on the bottom corner of the Park Assist view.

NOTE: If Park Assist is unable to provide feedback, the instrument panel displays an alert message.

CAUTION: Keep cameras clean from dirt, debris, snow, and ice. Avoid using a high pressure power washer on the cameras, and do not clean a camera with a sharp or abrasive object that can scratch or damage its surface.

CAUTION: Do not install accessories or stickers on or near the cameras.

Controlling Audible Feedback

You can use Park Assist with or without audible feedback. To turn chimes on or off, touch **Controls > Safety > Park Assist Chimes**.

To mute the chimes temporarily, touch the speaker icon in the bottom corner of the Park Assist view. The chimes are muted until you shift or drive over the speed at which Park Assist operates.

Limitations and False Warnings

Park Assist may not function correctly in these situations:

- One or more of the sensors (if equipped) or cameras is damaged, dirty, or obstructed (such as by mud, ice, or snow, or by a vehicle bra, excessive paint, or adhesive products such as wraps, stickers, rubber coating, etc.).
- The object is located below approximately 20 cm (such as a curb or low barrier).



CAUTION: Shorter objects that are detected (such as curbs or low barriers) can move into a blind spot. Model X cannot alert you about an object while it is in a blind spot.

- Weather conditions (heavy rain, snow, or fog).
- The object is thin (such as a sign post).
- Park Assist's operating range has been exceeded.
- The object is sound-absorbing or soft (such as powder snow).
- The object is sloped (such as a sloped embankment).
- Model X has been parked in, or being driven in, extremely hot or cold temperatures.
- The object is located too close to the bumper.
- A bumper is misaligned or damaged.
- An object that is mounted to Model X is interfering with and/or obstructing Park Assist (such as a bike rack or bumper sticker).
- Model X rolls freely in the opposite direction you selected (for example, Park Assist does not display an alert if Model X rolls backwards down a hill while in Drive).

Other Parking Aids

In addition to Park Assist, when shifted into Reverse, the backup camera displays a view of the area behind Model X (see [Rear Facing Camera\(s\) on page 101](#)).



Vehicle Hold

When Model X is stopped, Vehicle Hold can continue to apply the brakes even after you remove your foot from the brake pedal.

Vehicle Hold will activate:

- **Hold:** Vehicle Hold is automatically enabled any time the vehicle comes to a complete stop.
- **Creep or Roll:** Vehicle Hold is enabled automatically anytime the vehicle is at a standstill and the brake is pressed to the floor.



This indicator displays on the instrument panel whenever Vehicle Hold is actively braking Model X.

To disengage Vehicle Hold, press the accelerator pedal or press and release the brake pedal.

NOTE: Shifting into Neutral also disengages Vehicle Hold.

NOTE: After actively braking Model X for approximately ten minutes, Model X shifts into Park and Vehicle Hold cancels. Model X also shifts into Park if it detects that the driver has left the vehicle.



What It Is

The traction control system constantly monitors the speed of the front and rear wheels. If Model X experiences a loss of traction, the system minimizes wheel spin by controlling brake pressure and motor power. By default, the traction control system is on. Under normal conditions, it should remain on to ensure maximum safety.



This yellow indicator flashes on the instrument panel whenever the traction control system is actively controlling brake pressure and motor power to minimize wheel spin. If the indicator stays on, a fault is detected with the traction control system. Contact Tesla Service.

WARNING: Traction control cannot prevent collisions caused by driving dangerously or turning too sharply at high speeds.

Allowing Wheel Slip

To allow the wheels to spin at a limited speed, you can enable **Slip Start**. **Slip Start** can be enabled only when Model X is moving 48 km/h or slower. **Slip Start** automatically disables when the speed exceeds 80 km/h.

Under normal conditions, **Slip Start** should not be enabled. Enable it only in circumstances where you deliberately want the wheels to spin, such as:

- Starting on a loose surface, such as gravel or snow.
- Driving in deep snow, sand or mud.
- Rocking out of a hole or deep rut.

To allow the wheels to spin, touch **Controls > Pedals & Steering > Slip Start**.



The instrument panel displays an alert message when **Slip Start** is enabled.

Although **Slip Start** is automatically disabled the next time you start Model X, it is strongly recommended that you disable it immediately after the circumstances that required you to enable it have passed.

NOTE: **Slip Start** cannot be enabled when you are actively using cruise control.



Acceleration Modes

The acceleration settings available on your Model X vary depending on options chosen at time of purchase:

- **Chill:** limits acceleration for a smooth and gentle ride (available on all vehicles equipped with Autopilot hardware).
- **Standard:** provides the normal level of acceleration (available on non-Performance All-Wheel Drive vehicles).
- **Sport:** provides the normal level of acceleration (available on Performance All-Wheel Drive vehicles).
- **Insane:** increases peak torque by approximately 30 percent (available on Performance All-Wheel Drive vehicles not equipped with the Ludicrous upgrade).
- **Ludicrous:** increases peak torque by approximately 60 percent (available on Performance All-Wheel Drive vehicles equipped with the Ludicrous upgrade).
- **Insane+:** increases peak torque by approximately 30 percent (available on Performance All-Wheel Drive vehicles not equipped with the Ludicrous upgrade) while also heating up the Battery to its ideal operating temperature to ensure access to 100% of available power. Before choosing this setting, read about [Using Insane+ or Ludicrous+ on page 96](#).
- **Ludicrous+:** increases peak torque by approximately 60 percent (available on Performance All-Wheel Drive vehicles equipped with the Ludicrous upgrade) while also immediately heating up the Battery to its ideal operating temperature to ensure access to 100% of available power. Before choosing this setting, read about [Using Insane+ or Ludicrous+ on page 96](#).

NOTE: Although Chill does not directly improve driving range, using the increased torque and power available in Insane or Ludicrous mode can reduce range and efficiency.

NOTE: When Chill is selected, Chill displays on the instrument panel above the driving speed.

In addition, a Performance All-Wheel Drive Model X also features Launch Mode to provide optimum acceleration on surfaces with good traction. For the specific driving instructions required to use Launch Mode, see [Launch Mode on page 96](#).

To choose an acceleration mode, touch **Controls > Pedals & Steering > Acceleration**.

Using Insane+ or Ludicrous+

If you choose Insane or Ludicrous, additional power is available immediately. However, to achieve the absolute maximum power (designed for short term use), you can choose **Insane+** or **Ludicrous+** to heat the Battery to its ideal operating temperature. This ensure access to 100% of available power.

While the battery is being heated, the touchscreen displays a status message providing you with an approximate wait time, and letting you know when the additional power is available. In addition to heating the Battery, **Insane+** and **Ludicrous+** modes strive to keep the Battery within an optimal

temperature range. Therefore, under aggressive driving scenarios, you may also see the "Cooling" status for several minutes until temperatures fall. Model X stays in the chosen mode for three hours, even if you leave the vehicle. After three hours, the feature times out.

NOTE: Insane+ and Ludicrous+ are designed to achieve maximum performance for short term acceleration. These settings are not intended for daily driving. The tradeoff for the additional power boost is extra energy consumption and earlier power fade on long drives. The Insane or Ludicrous acceleration settings provide a significant increase in performance even without choosing the Insane+ or Ludicrous+ setting to achieve maximum Battery power. In fact, in normal driving situations, the additional power that can be achieved using Insane+ and Ludicrous+ may be unnoticeable.

NOTE: To support Insane+ or Ludicrous+, the charge level must be 20% or higher. You cannot initiate these settings if the charge level is less than 20%. In addition, these settings immediately cancel if at any time during use, the charge level drops below 20%.

When using Insane+ or Ludicrous+, Model X consumes more energy to keep the Battery within an optimal temperature range.

To cancel Insane+ or Ludicrous+ at any time, change the acceleration level to another setting. To prevent excess and potentially unnecessary energy consumption (for example, you leave the vehicle and forget to cancel Insane+ or Ludicrous+), these settings cancel automatically in three hours, regardless of whether you are still driving or have left the vehicle.

NOTE: Insane+ or Ludicrous+ strives to keep the Battery within an optimal temperature range. In addition to heating the Battery, these settings also cool the battery when necessary (for example, while driving at high speeds, during rapid acceleration, driving for long periods, etc.).

Launch Mode

Launch Mode, available on Performance All-Wheel Drive vehicles only, provides optimum acceleration on surfaces with good traction.

NOTE: Hard acceleration including, but not limited to, using launch mode, increases stress on the vehicle's powertrain, and can cause premature wear and aging of various components. Model X constantly monitors powertrain fatigue and damage, and notifies you if vehicle components need to be serviced.



WARNING: Use Launch Mode only in appropriate locations where there is no cross traffic or pedestrians present. Launch Mode is designed for use on closed circuit driving courses. It is the driver's responsibility to ensure that driving style and acceleration do not endanger or inconvenience other road users.



To Activate Launch Mode

1. Ensure the brakes are slightly warm by driving for a few minutes and using the brakes a few times.
2. Set the air suspension to Low or Very Low (see [Air Suspension on page 90](#)).
3. Set the acceleration level to **Insane+** or **Ludicrous+** (if equipped).
NOTE: If equipped with the **Ludicrous+** setting, you can achieve optimum performance by pressing and holding this setting for three seconds.
4. With Model X shifted into Drive and at a complete stop with the steering wheel straight, firmly hold the brake pedal with your left foot, then fully press the accelerator pedal. Within one second, the instrument panel displays a message indicating that Launch Mode is enabled.
5. Within twelve seconds of Launch Mode being enabled, release the brake pedal to launch the vehicle.

When you release the brake, Model X launches forward.

NOTE: Launch Mode is not available if Slip Start has been enabled (which allows the wheels to spin). See [Traction Control on page 95](#).

NOTE: Launch Mode is available only if the ambient temperature is 3° C or warmer.



Driver Profiles

When you first adjust the driver's seat, steering wheel position, or exterior side mirrors, the touchscreen prompts you to create a driver profile to save these adjustments. Your profile also saves various preferences you make while customizing Model X.



To add a new driver profile, touch the driver profile icon at the top of the touchscreen. Then touch **Driver Profile Settings > Add New Driver**, type the driver's name and touch **Create Profile**. Follow the onscreen instructions.

Check the **Use Easy Entry** checkbox if you want to save (or use existing) **Easy Entry** settings in which the driver's seat and the steering wheel are automatically adjusted to make it easy to enter and exit Model X.

If you change the position of the driver's seat, steering wheel, or exterior side mirrors after you have saved or chosen a driver profile, the touchscreen prompts you to **Save** the new position or **Restore** the previously saved position (other settings are automatically saved). To change a setting without saving or restoring, just ignore the prompt.

To delete a driver profile, touch the driver profile icon at the top of the touchscreen, touch **Driver Profile Settings** and select the driver profile you want to remove. Once selected, **Delete** the driver profile.

NOTE: Valet mode is a built-in driver profile that limits speed and restricts access to some Model X features (see [Valet Mode on page 98](#)).

NOTE: To stop automatic adjustments that are in process based on a driver's profile, touch **Stop** on the Driver Profile dropdown menu. Automatic adjustments also stop if you manually adjust a seat, mirror, or the steering wheel.

Selecting Between Driver Profiles



To adjust Model X based on a driver's profile, touch the driver profile icon at the top of the touchscreen. Then choose the driver, and Model X is adjusted based on the settings that have been saved to the chosen driver profile.

Saved Settings

A subset of the settings that you choose to customize your Model X are automatically saved to your driver's profile. Once saved, a green check mark appears next to the driver profile icon on the touchscreen. Examples of automatically saved driver profile settings are:

- Navigation, temperature, lights and display settings.
- Autopilot and driving preferences.

Linking a Driver Profile to a Key Fob

You can link a driver profile to a specific key fob to allow Model X to automatically select the correct driver profile when the linked key fob is detected as you approach the vehicle and open the driver's door. To link a driver profile to a key fob, enter Model X with the key fob and touch the driver profile icon at the top of the touchscreen. Select the driver profile you would like to link to the key fob, then touch **Link to Key Fob**.

NOTE: Model X detects only one key fob at a time. The driver profile is linked to the key fob that is detected by the vehicle at that time. Therefore, if you want to link driver profiles to multiple key fobs, ensure that only the key fob that you would like to link the driver profile to is within detection range while performing the linking procedure. Move all other key fobs outside of the detection range (at least one meter away from Model X).

NOTE: Model X can support up to eight linked key fobs. However, a driver profile can only be linked to one key fob.

To remove the link between a driver profile and key fob, touch the driver profile icon at the top of the touchscreen. Select the driver profile, then touch the **X** next to **Linked to Key Fob**.

Easy Entry

You can define an Easy Entry setting that moves the steering wheel and driver's seat to make it easy to enter and exit Model X. Any driver can use the Easy Entry setting by associating it with their driver profile. When the Easy Entry setting is associated with a driver profile, the steering wheel and driver's seat automatically adjust when in Park and the driver's seat belt is unbuckled, allowing an easy exit from (and next entrance into) Model X. When returning to the vehicle and stepping on the brake pedal, settings automatically adjust back to the settings used by the most recent driver profile (or based on the key if it's linked to a driver profile).

To use **Easy Entry** with a driver profile, ensure the **Use Easy Entry** box is checked.



WARNING: Never use Easy Entry to move the driver's seat to the full rearward position when a child safety seat is installed on a rear seat located behind the driver's seat. With reduced clearance, the movement of the seat may impact a child's legs, cause injury, or dislodge the seat.

Valet Mode

When Model X is in Valet mode, the following restrictions apply:

- Speed is limited to 113 km/h.
- Maximum acceleration and power are limited.
- Front trunk and glovebox are locked.



- Home and Work locations are not available in the navigation system.
- Voice commands are disabled.
- Text messages are not displayed.
- Autopilot convenience features are disabled.
- The Allow Mobile Access setting cannot be changed.
- HomeLink (if available in your market region) is not accessible.
- Driver Profiles are not accessible.
- Some apps, such as Toybox and Theater, are not accessible.
- Wi-Fi and Bluetooth are disabled. When Model X is in Valet mode, you cannot pair new Bluetooth devices or view or delete existing paired devices. However, if a Bluetooth-paired device or a known Wi-Fi network is within range, Model X connects to it.

When you cancel Valet mode, all settings associated with the most recently used driver profile and climate control settings are restored, and all features are available.

NOTE: You do not need to enter a PIN to cancel Valet mode from the mobile app.

Starting Valet Mode

With Model X in Park, touch **Controls > Controls > Safety > Valet Mode**, or touch the driver profile icon at the top of the touchscreen, then touch **Valet Mode**.

The first time you enter Valet mode, the touchscreen prompts you to create a 4-digit PIN you will use to cancel Valet mode.

When Valet mode is active, the instrument panel displays the word **Valet** while the driver profile changes to **Valet Mode** on the touchscreen.

You can also use the mobile app to start and cancel Valet mode (if Model X is in Park). When using the mobile app, you do not need to enter a PIN because you are already required to log into the app using your Tesla Account credentials.

NOTE: If **PIN to Drive** is enabled (see [PIN to Drive on page 143](#)), you must enter the driving PIN before you can define or enter a Valet PIN. Once in Valet mode, Model X can be driven without the valet needing to enter the driving PIN.

NOTE: The **PIN to Drive** setting is not available when Valet mode is active.

If you forget your valet PIN, reset it from inside Model X by entering your Tesla Account credentials (which also cancels Valet mode). You can also reset your PIN using the mobile app.



WARNING: Do not use Valet mode when towing a trailer. The torque limitations of Valet mode can make it difficult for Model X to pull a trailer up a hill.

Canceling Valet Mode

With Model X in Park, touch the **Valet Mode** driver profile icon at the top of the touchscreen, and enter your 4-digit PIN.



Displaying Trip Information

Trip information displays on the touchscreen when you touch **Controls > Trips**. For the current trip, you can display distance, duration and average energy usage. You can also show distance and total and average energy used since your last charge and for additional trips.

To name or rename a trip, touch the trip's name, enter a new name for the trip, then press **Save**. To reset a particular trip meter, touch its associated **Reset** button.

You can display information for up to three trips on the instrument panel. Use the checkboxes to specify the trip(s) you want to display. Then use the scroll wheel on the right side of the steering wheel to display the chosen trip(s) (see [Using Right Steering Wheel Buttons on page 78](#)).

Odometer

To display the odometer and view vehicle mileage, do either of the following:

- Touch **Controls > Software**.
- Touch **Controls > Trips**.
- Open the mobile app and scroll down to the bottom of the main screen.



Camera Location

Model X is equipped with a rear view camera located above the rear license plate.

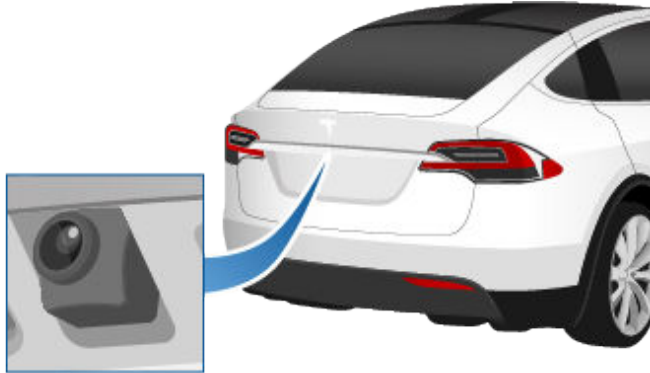

Whenever you shift into Reverse, the touchscreen displays the view from the camera. Lines show your driving path based on the position of the steering wheel. These lines adjust as you move the steering wheel.

A vertical red bar appears over the rear view camera feed if Model X detects an object (such as another vehicle or a pedestrian) about to cross behind the vehicle. For more information, see [Rear Cross Traffic Alert on page 139](#).

Model X also displays images from the side cameras (if equipped). Simply swipe up or down to hide or show the side camera views.

NOTE: You may need to expand the camera window to see the images from the side cameras (if equipped).

NOTE: Visual feedback from Park Assist also appears on the instrument panel (see [Park Assist on page 92](#)).



To display the view from the rear view cameras at any time, open the app launcher and touch the Camera app.

If a black screen appears on the touchscreen instead of the rear view camera feed when in Reverse, use the rear view mirrors and ensure your surroundings are safe before continuing to Reverse. If inoperability of the rear view camera persists, use the mobile app to schedule a service appointment.

WARNING: Never depend on the cameras to inform you if the area behind you is free of objects and/or people. The cameras may not detect objects or barriers that can potentially cause damage or injury. In addition, several external factors can reduce the performance of the cameras, including a dirty or obstructed lens. Therefore, depending on the cameras to determine if Model X is approaching an obstruction can result in damage to the vehicle and/or objects and can potentially cause serious injury. Always inspect the area with your own eyes. When reversing, perform shoulder checks and use all mirrors. Use the cameras for guidance purposes only. It is not intended to replace your own direct visual checks and is not a substitute for careful driving.

To ensure a clear picture, the camera lens must be clean and free of obstructions. See [Cleaning on page 191](#).



Pedestrian Warning System

(If equipped) The Pedestrian Warning System causes Model X to emit sound when driving below approximately 33 km/h (21 mph) or while driving in reverse. Electric vehicles operate quietly and this sound helps to alert pedestrians of your oncoming vehicle. The sound, which activates whenever Model X is shifted out of Park, gets louder as speed increases.

NOTE: The Pedestrian Warning System may not be available in vehicles manufactured prior to approximately July 1, 2021.

 **WARNING:** If sound cannot be heard, pedestrians may not be aware of your oncoming vehicle, which may increase the likelihood of a collision resulting in serious injury or death. Never rely on the Pedestrian Warning System to make sure that pedestrians are aware of your vehicle. If the Pedestrian Warning System is not operating, schedule a service appointment.



NOTE: Depending on date of manufacture and vehicle configuration, Model X may not be equipped with the active spoiler.

Model X has a rear spoiler designed to improve aerodynamics. If Model X is equipped with the active spoiler, the position of the spoiler can vary depending on the status and speed of Model X:

- When Model X is in Reverse or when driving speed is below 16 km/h, the spoiler provides maximum visibility behind Model X.
- When driving speed exceeds 72 km/h, the spoiler lowers to the position that provides the most effective aerodynamics.
- When Model X is powered off and locked, the spoiler retracts.

To allow the spoiler to automatically move as described above, touch **Controls > Service > Spoiler Mode > Automatic**. To disable automatic movement of the spoiler and keep it in its extended position, choose the **Extended** setting.

NOTE: If the spoiler can not automatically lower or raise, the instrument panel displays an alert. Contact Tesla Service.



Towing and Accessories

The towing package allows you to tow a trailer with your Model X. It also allows you to carry skis, snowboards, bicycles, etc. by attaching an accessory carrier to the hitch.

Carrying Accessories

The Model X towing package has a 50 mm ball coupling that can support an accessory carrier.

The ball coupling is designed to support vertical loads of up to 54 kg when the load is cantilevered rearward within 63 cm of the ball coupling, such as when carrying bikes on an accessory rack.

When carrying bicycles or other items on the Model X hitch, always check to ensure that the maximum weight is not exceeded. When calculating weight, remember to include the weight of the accessory carrier. For example, assuming the carrier weighs 14 kg, the weight threshold is sufficient for carrying two bicycles weighing approximately 20 kg each, or four bicycles weighing approximately 10 kg each.

 **CAUTION:** The Model X hitch is designed to support up to 54 kg. Exceeding this maximum weight can cause significant damage.

 **CAUTION:** Do not attempt to install a carrier on a Model X that is not equipped with the towing package. Doing so can cause significant damage.

To install and use an accessory carrier, the tow hitch must be connected (see [Connecting the Tow Hitch on page 109](#)). Then follow the instructions provided with your accessory carrier. Observe all regulations and legal requirements in your state/region that apply to carrying accessories.

The Model X towing package includes the wiring necessary for using an accessory carrier equipped with lights (see [Electrical Connections on page 110](#)). The package also includes Trailer Mode software (see [Trailer Mode on page 106](#)).



When you connect an accessory carrier's wiring harness, Model X detects a connection for trailer lights and this indicator illuminates on the instrument panel. Trailer Mode is disabled.

When carrying accessories, periodically confirm that the accessory carrier and its cargo remain secure at all times, and if applicable, that the lights on the accessory carrier are working.

NOTE: Go to www.tesla.com to purchase accessories for your Model X. Although third-party products are available, Tesla recommends and supports only Tesla-approved products (see [Parts and Accessories on page 198](#)). The accessory products available for your Model X vary based on market region. Before attempting to install a non-Tesla carrier, review the product information to ensure compatibility.

NOTE: When not in use, the hitch should be removed and stored in a dry location to prevent rust and corrosion. Keep the dust cover over the hitch housing to prevent dirt and debris from entering (see [Disconnecting the Tow Hitch on page 110](#)).



CAUTION: A carrier may obscure your view from the rear view mirror or the rear camera(s). In addition, some Autopilot features may not function as expected.



WARNING: Tesla assumes no responsibility for damage or injuries resulting from installing and using an accessory carrier, for any omissions in the instructions accompanying an accessory carrier, or for your failure to follow the instructions. Damage caused by using an accessory carrier is not covered by the warranty.



Towing Capacity

The total trailer weight (including all cargo and additional equipment), and the trailer tongue weight, must never exceed the following:

Wheel/Rim Size	Maximum Towing Capacity*	Maximum Tongue Weight**
20" or 22"	2300 kg	100 kg

*Tesla recommends a separate braking system on trailers with a loaded weight of over 450 kg. The braking system must be appropriate for the weight of the trailer. Follow the instructions provided by the trailer brake manufacturer to ensure that trailer brakes are properly installed, adjusted, and maintained.

**The tongue weight is the downward force that the weight of the trailer exerts on the hitch. It is the technically permissible maximum mass at the coupling point (100 kg, or 90 kg for Plaid models). It must not be less than 4% of the trailer load. Carrying a significant amount of equipment, passengers, or cargo in the tow vehicle can reduce the tongue weight it can handle, which also reduces the maximum towing capacity. Maximum towing capacity is calculated assuming the TPMLM (Technically Permissible Laden Mass) is not exceeded. The TPMLM is printed on the Statutory Plate (see [Statutory Plate on page 203](#)).

Tire Pressures when Towing

When towing a trailer, tire pressures must be adjusted to accommodate the additional load. Keep tires inflated to the pressures shown below (these pressures override the pressures that are provided on the Tire and Loading information label):

Front Tires	Rear Tires	Cold Tire Inflation Pressure
245/45R19	245/45R19	45 psi (310 kPa)
255/45R20 265/45R20	275/45R20	46 psi (320 kPa)
265/35ZR22	285/35ZR22	50 psi (345 kPa)

WARNING: Check tire pressures using an accurate pressure gauge when tires are cold. Driving 1.5 km warms the tires sufficiently to affect tire pressures. Parking the vehicle in direct sunlight or in hot weather can also affect tire pressures. If you must check warm tires, expect increased pressures. Do not let air out of warm tires in an attempt to match recommended cold tire pressures. A hot tire at or below the recommended cold tire inflation pressure is dangerously under-inflated.

WARNING: Never attempt to tow a trailer when a Model X tire is faulty or has been inflated using a tire repair kit. A temporarily repaired tire is not designed to sustain the towing load. Towing using a faulty or temporarily repaired tire can result in tire failure and loss of vehicle stability.

Before Towing a Trailer

Before towing a trailer, you must do the following:

- Inflate tires to the cold tire inflation pressure specified in Tire Pressures when Towing.
- Set the Suspension height to **Low** (touch **Controls** > **Suspension** > **Low**).
- Observe all regulations and legal requirements in your state/region that apply to trailer towing. Failure to comply with regulations can compromise your safety.
- Adjust side mirrors to provide a clear rearward view without a significant blind spot.
- Engage **Trailer Mode** (see [Trailer Mode on page 106](#)).

Confirm the following:

- Model X rests horizontally with the trailer attached. If the vehicle is tipped up at the front, and down at the rear, check that you are not exceeding the maximum towing capacity and tongue loads provided in Carrying Capacity.
- All trailer hitch parts and attachments and electrical connectors (including reverse and fog lights, if equipped) are in good condition and are properly connected. If any problems are apparent, do not tow the trailer.
- Trailer lights (brake lights, turn signal lights, and marker lights) are working properly.
- The trailer tongue is securely connected to the hitch ball.
- All cargo is secured.
- Wheel chocks are available.
- The trailer load is evenly distributed such that the trailer tongue weight is approximately 4% of the total trailer weight, without exceeding the maximum tongue weights provided in Carrying Capacity.

WARNING: The trailer tongue weight must be approximately 4% of the total trailer weight without exceeding the maximum tongue weights provided in Carrying Capacity. Loads that are balanced over the wheels or heavier in the rear can cause trailer sway, resulting in loss of vehicle control.

WARNING: Always ensure that cargo is secured in the trailer and will not shift. Dynamic load shifts can cause loss of vehicle control, resulting in serious injury or death.

Trailer Mode

Trailer Mode must always be active when towing a trailer. When you connect a trailer's electrical connection, Model X automatically engages Trailer Mode. When you disconnect the trailer's electrical connection, Trailer Mode disengages. To engage or exit Trailer Mode manually, touch **Controls** > **Pedals & Steering** > **Trailer Mode** on the touchscreen. One of the following indicators display on the instrument panel:



Trailer Mode is active.



Model X detects a connection for trailer lights but Trailer Mode is disabled. It is likely that a carrying accessory has been connected.



Model X detects a faulty electrical connection for the trailer lights. Some, or all, trailer lights may not be functioning. Pull over as soon as safety permits and inspect the trailer lights for faulty cabling or connections. If the issues are resolved and the red icon still persists, turn Trailer Mode off and on again.



NOTE: In situations where Model X detects a heavy load, it assumes that a trailer is connected and automatically engages Trailer Mode. A message displays on the instrument panel informing you that Trailer Mode has been engaged. When Trailer Mode is entered automatically due to detection of a heavy load, you can change the Trailer Mode setting only by stopping Model X, engaging Park or Neutral, then manually applying the parking brake using the touchscreen (**Controls > Safety > Parking Brake**).

Some Autopilot features, as well as rear parking sensor functionality, may not be available when Trailer Mode is enabled. In addition, some features may operate differently. For example:

- Autosteer is unavailable.
- Traffic-Aware Cruise Control increases the following distance from the car in front of you.
- The air suspension system will not make speed-based adjustments from **Standard** to **Low**.
- The air suspension system does not automatically raise ride height based on saved locations.
- Side collision warnings are active but automatic steering interventions are disabled.
- The braking force provided by Automatic Emergency Braking (see [Collision Avoidance Assist on page 138](#)) is significantly limited.

WARNING: Do not rely on Model X to detect the trailer and automatically engage Trailer Mode. Always check that Trailer Mode is engaged before towing a trailer.

WARNING: Under no circumstances should you exit Trailer Mode when towing a trailer. Doing so can cause serious injury and/or death.

WARNING: Do not use the suspension setting to appropriately match the height of the hitch with the height of the trailer.

Trailer Brakes

When towing a loaded trailer that weighs more than 450 kg, Tesla recommends that the trailer be equipped with its own brake system adequate for the weight of the trailer. Ensure compliance with local regulations. A brake controller must be purchased separately, and the required 4-pin pigtail connector can be ordered from Tesla Service.

Follow these steps to connect a brake controller:

1. Connect the wiring on the brake controller to the appropriate locations on the 4-pin pigtail connector.

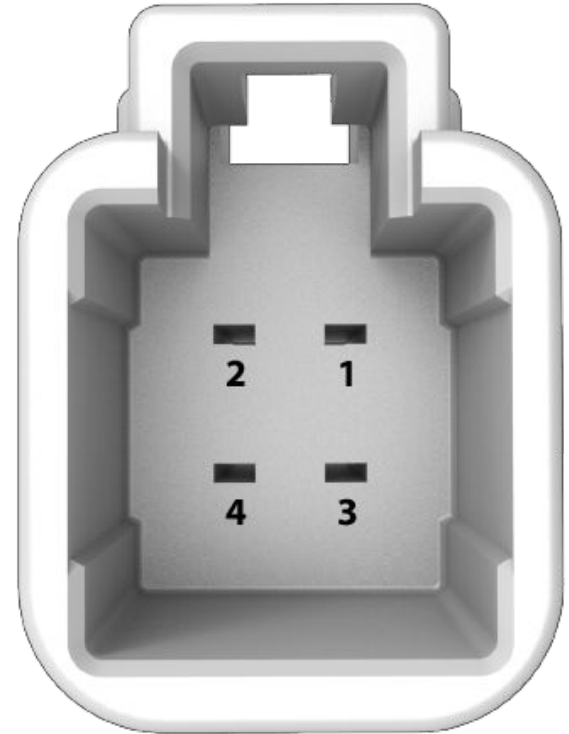

1 - Brake control output to trailer

2 - Ground

3 - Brake On Signal

4 - Low Voltage Power (20A)

2. Remove the cover located under the dashboard in the driver's side foot well.

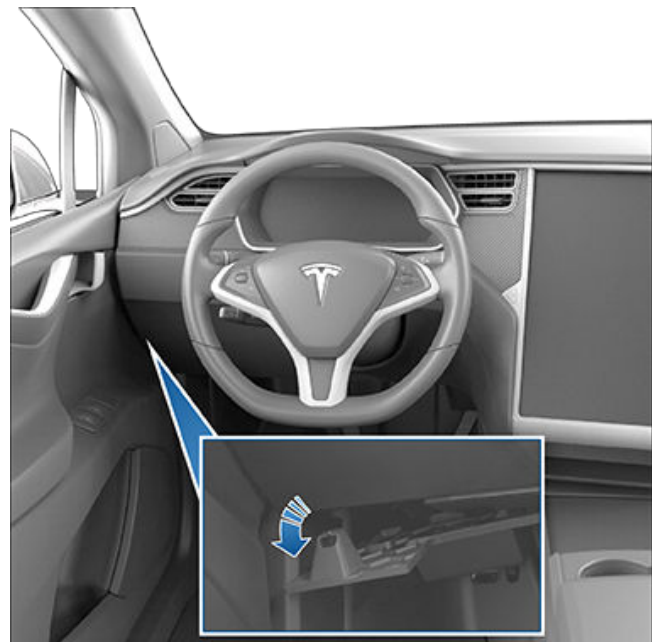



Towing and Accessories

3. Peel back the carpet to expose Model X's 4-pin connector on the wiring harness.



4. Connect the pigtail connector to the vehicle wiring connector.

⚠ WARNING: Towing increases your stopping distance, even when the trailer is equipped with its own braking system. When towing, increase your following distance and avoid situations that could potentially cause heavy braking. Failure to do so can result in a collision.

⚠ WARNING: Observe all regulations and legal requirements in your regional and national jurisdictions that apply specifically to trailer towing and brake requirements. Many regions require a breakaway switch, located on the tongue of the trailer, to activate the trailer brakes in the event that the trailer separates from the vehicle. Failure to comply with regulations can compromise your safety.

⚠ WARNING: Follow the instructions provided by the trailer brake manufacturer to ensure that trailer brakes are properly installed, adjusted, and maintained. Tesla is not responsible for damages caused by incorrect installation of trailer braking systems.

⚠ WARNING: Never attempt to connect trailer brakes directly to the vehicle braking system. Doing so can cause damage to the vehicle and the trailer, and can cause the braking system to malfunction, resulting in serious injury or death.

Towing Guidelines

Model X is designed primarily as a passenger-carrying vehicle. Towing a trailer puts additional load on the motor(s), drive train, brakes, tires, and suspension and significantly decreases range. If you decide to tow a trailer, proceed with caution and follow these general guidelines:

- Reduce your driving speed and avoid sudden maneuvers. Keep in mind that when towing a trailer, steering, stability, turning radius, stopping distance and braking performance are different when compared to driving without a trailer.
- Increase your following distance by maintaining at least twice the distance from a vehicle ahead. This helps to avoid situations that require heavy braking. Sudden braking may result in skidding or jack-knifing, and loss of control.
- Avoid sharp turns. Sharp turns can cause the trailer to contact the vehicle and cause damage. Keep in mind that the trailer wheels are closer to the inside of the turn than the vehicle's wheels. Therefore, make wider turns to prevent the trailer from hitting curbs, road signs, trees or other objects.
- Periodically check the trailer lights and turn signals to confirm that bulbs are still working. When towing a trailer, the turn signal arrows on the vehicle instrument cluster flash as normal, even if the bulbs on the trailer are burned out.
- Periodically confirm the cargo is secure.
- Periodically confirm the trailer brakes are working.
- Avoid parking on a grade (see [Parking with a Trailer on page 108](#)).
- Regularly confirm that all towing components are securely tightened.

Parking with a Trailer

Whenever possible, avoid parking on a grade. However, if parking on a grade is absolutely necessary, place wheel chocks under the trailer wheels:

- One person presses and holds the brake pedal.
- A second person places the wheel chocks under the wheels on the downgrade side of the vehicle's tires.
- When the chocks are in place, release the brake pedal and ensure the chocks hold the weight of the vehicle and trailer.

NOTE: When testing chocks, ensure that Vehicle Hold (see [Vehicle Hold on page 94](#)) is not engaged. If Vehicle Hold is braking Model X, the Vehicle Hold indicator light displays on the instrument panel. To disengage Vehicle Hold, press and release the brake pedal.

- Place the vehicle in Park.

⚠ WARNING: If parking on a grade is necessary, always ensure that all trailer wheels have been securely chocked. Failure to do so can result in serious damage, injury, or death.



Trailer Sway Mitigation

When trailer sway is detected, the Model X electronic stability control system attempts to apply the appropriate amount of braking to minimize trailer sway. The instrument panel briefly displays the traction control system indicator. Pressing the brake pedal when the system is actively braking to mitigate trailer sway does not cancel this automatic braking.

Connecting the Tow Hitch

The Model X towing package includes a weight-carrying hitch with a 50 mm ball coupling. When not in use, the hitch should be removed and stored in a dry location to prevent rust and corrosion. Keep the dust cover over the hitch housing to prevent dirt and debris from entering.

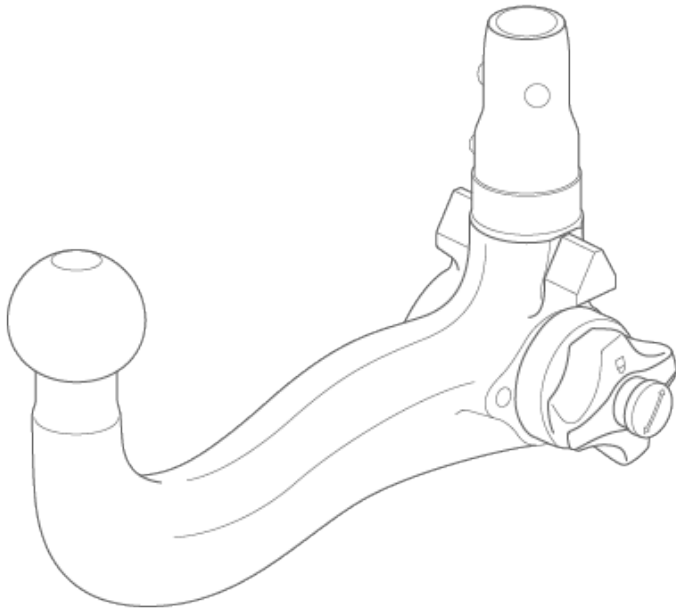

The trailer hitch assembly is attached to the body of the vehicle with 8 nuts.



NOTE: The maximum permissible rear overhang for the coupling point is 1186 mm.

NOTE: Always attach safety chains when towing. Cross the chains under the trailer tongue and attach to the trailer eyelets to ensure the security of the trailer load.

⚠ WARNING: You must use the Model X trailer hitch when towing a trailer. Never attempt to attach a different type of trailer hitch.

To install the trailer hitch:

1. Remove the dust cover from the hitch housing.



2. Insert the key into the locking cylinder on the hitch, and turn the cylinder so the top of the key is aligned with the "unlocked" position.
3. Pull the locking cylinder out of the adapter approximately 0.5 cm, and turn clockwise until the red marking on the cylinder aligns with the white dot.



Towing and Accessories



⚠ WARNING: Be careful when turning the locking cylinder. If it does not lock into the "Open Position", it automatically retracts into its original "Closed Position" and can pinch your fingers.

4. Firmly grasp the hitch from the bottom and align the triangular-shaped guides at the sides of the hitch with the corresponding cutouts in the hitch housing.

NOTE: Do not grasp the locking cylinder because it needs to rotate freely.

5. Push the hitch into the hitch housing until the locking cylinder rotates approximately 120° counter-clockwise and automatically locks into the "Closed Position". The green area on the locking cylinder (above the white arrow) aligns with the white dot on the housing.
6. Visually check to confirm that the hitch is fully inserted into the housing. Try pulling down on the hitch. The hitch should not drop when you pull down.

NOTE: If the hitch does not lock into the housing, it falls out when you pull down on it.

7. Turn the key so the arrows align with the "locked" marking on the locking cylinder.
8. Remove the key and store it in a safe place (preferably inside the vehicle).

NOTE: The key can be removed only if the hitch is locked. This indicates a proper connection. Do not use the hitch if the key is not removed.

NOTE: Tesla recommends making a note of the key code. You need this code if you lose the keys and need to order a replacement.

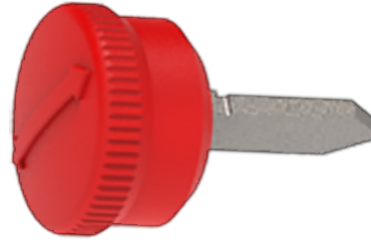

9. Close the dust cover to prevent dirt and debris from entering the lock. For newer version with push clips, reattach the dust cover, snap it in place and open the push clips before pushing them in.

NOTE: To maintain the hitch, regularly grease its surfaces with non-resinous grease.

Disconnecting the Tow Hitch

After towing, remove the hitch:

1. Insert the key and turn to align the top of the key with the "unlocked" position.
2. While firmly holding the bottom of the hitch (to prevent it from dropping to the ground), pull the locking cylinder out approximately 0.5 cm, and turn it clockwise until the red marking on the locking cylinder aligns with the white dot. At this point, the locking cylinder is locked in the "open" and the hitch drops out of the housing.

⚠ WARNING: Be careful when turning the locking cylinder. If it does not lock into the "Open Position", it automatically retracts into its original "closed" position and can pinch your fingers.

3. Reinstall the dust cover on the hitch housing to prevent dirt from accumulating inside the housing.
4. Close the dust cover on the hitch's locking cylinder and store the hitch in a secure location.

Electrical Connections

Regulations require all trailers to be equipped with tail lights, brake lights, side marker lights, and turn signals. To provide power for trailer lighting, a built-in 13-pin wiring connector is provided near the hitch support's wiring plugs from most types of trailers.



Plugging trailer wiring into the Model X electrical connector automatically engages Trailer Mode (see [Trailer Mode on page 106](#)).

⚠ WARNING: Use only the electrical connection designed by Tesla. Do not attempt to directly splice or attempt to connect a trailer's electrical wiring using any other method. Doing so can damage the vehicle electrical system and cause malfunctions.

⚠ CAUTION: Always ensure that the trailer electrical cable does not contact or drag on the ground and there is enough slack in the cable to allow for turns.

Impact on Range

Towing a trailer and carrying accessories increases vehicle weight and drag. As a result, driving range can decrease significantly. Although Trip Planner attempts to adjust estimates based on Trailer Mode, actual energy consumption may vary. Plan trip length and charging destinations accordingly.

1. Left Turn Signal (Yellow)
2. Rear Fog (Blue)
3. Ground for Pins 1-8 (White)
4. Right Turn Signal (Green)
5. Right Tail Lamp (Brown)
6. Stop Lamps (Red)
7. Left Tail Lamp (Black)
8. Reverse Lamps (Pink)
9. Low Voltage Power - Permanent (Orange)
10. Low Voltage Power - Switched/Ignition (Grey)
11. Ground for Pin 10 (Black/White)
12. Trailer Brake Control Output (Light Grey)
13. Ground for Pin 9 (Red/White)

NOTE: All pins have Low Voltage power.

NOTE: It is the driver's responsibility to ensure that all electrical connections are working and all trailer lights are operating before and during towing. You must perform manual checks.

NOTE: Loss of trailer lights when towing may be the result of a fault in the trailer wiring or excessive power consumption by the lights connected to the trailer output(s). When this occurs, a red Trailer Mode icon appears on the touchscreen. Fix any issues with the wiring and/or reduce the number of lights connected to the trailer output(s), then toggle Trailer Mode off and on again.

NOTE: If a trailer fog light is detected, Model X disables its rear fog light (if equipped).



About Autopilot

Autopilot is a suite of advanced driver assistance features that are intended to make driving safer and less stressful. None of these features make Model X fully autonomous or replace you as the driver. Autopilot features come standard with all new Tesla vehicles.

NOTE: Depending on market region, vehicle configuration, options purchased, and software version, your vehicle may not be equipped with the following features, or a feature may not operate exactly as described.

Autopilot includes Traffic-Aware Cruise Control.

- **Traffic-Aware Cruise Control:** Maintains your speed and an adjustable following distance from the vehicle in front of you, if there is one (see [Traffic-Aware Cruise Control on page 118](#)).

 **WARNING:** Autopilot is a hands-on feature. Keep your hands on the steering wheel at all times and be mindful of road conditions, surrounding traffic, and other road users (such as pedestrians and cyclists). Always be prepared to take immediate action. Failure to follow these instructions could cause damage, serious injury, or death.

Enhanced Autopilot includes additional features. Enhanced Autopilot Features are designed to further reduce driver workload and make common actions, such as changing lanes or parking, easier.

- **Auto Lane Change:** Moves Model X into an adjacent lane when you engage the turn signal and Autosteer is active (see [#unique_252 on page 123](#)).
- **Autopark:** Parks Model X, either parallel or perpendicularly (see [Autopark on page 123](#)).
- **Summon:** Moves Model X forward or backward, even while you're outside the vehicle. This is useful for parking in tight parking spots (see [Summon on page 125](#)).
- **Smart Summon:** Moves Model X out of a parking space and through more complex environments, maneuvering around obstacles and other vehicles, to meet you or go to a predetermined target (see [Smart Summon on page 128](#)).

 **WARNING:** Enhanced Autopilot is a hands-on feature. Keep your hands on the steering wheel at all times and be mindful of road conditions, surrounding traffic, and other road users (such as pedestrians and cyclists). Always be prepared to take immediate action. Failure to follow these instructions could cause damage, serious injury or death.

How It Works

Autopilot uses the cameras on Model X, which monitor the surrounding area and detect other vehicles, pedestrians, road markings, and obstacles such as barriers and curbs. There are cameras mounted on the front, rear, left, and right sides of Model X (see [Cameras on page 19](#)).

Model X may also be equipped with a cabin camera, mounted in the rear-view mirror, that monitors driver attentiveness. It is your responsibility to keep your hands on the wheel, pay attention to the road, and be ready to take immediate action at any time.

When Autopilot is engaged, Model X shows a series of escalating warnings reminding you to keep your hands on the wheel and pay attention to the road. If there is no response, Autopilot disengages and is unavailable for the remainder of the drive.

 **WARNING:** Autopilot is designed for your driving comfort and convenience and is not a collision warning or avoidance system. It is your responsibility to stay alert, drive safely, and be in control of the vehicle at all times. Never depend on Autopilot to adequately slow down Model X. Always watch the road in front of you and be prepared to take corrective action at all times. Failure to do so can result in serious injury or death.

It is your responsibility to familiarize yourself with the limitations of Autopilot and be ready to take control at all times.

Autopilot Conditions

Ensure all cameras are clean and free of obstructions before each drive and before using Autopilot features (see [Cleaning a Camera on page 191](#)). Dirty cameras and sensors (if equipped), as well as environmental conditions such as rain and faded lane markings, can affect Autopilot performance. If a camera is obstructed or blinded, Model X displays a message on the instrument cluster and Autopilot features may not be available.

Before you can use Autopilot features, and after some Service visits, you must drive a short distance to calibrate cameras. For more information, see [Drive to Calibrate Cameras on page 19](#).

In addition, these features may not work as intended when:

- The road has sharp curves or significant changes in elevation.
- Road signs and signals are unclear, ambiguous, or poorly maintained.
- Visibility is poor (due to heavy rain, snow, hail, etc. or poorly lit roadways at night)
- You are driving in a tunnel or next to a highway divider that interferes with the view of the camera(s)
- Bright light (such as from oncoming headlights or direct sunlight) interferes with the view of the camera(s).

The list above does not represent an exhaustive list of situations that may interfere with proper operation of Autopilot features.

NOTE: Depending on market region, vehicle configuration, options purchased, and software version, your vehicle may not be equipped with the following features, or a feature may not operate exactly as described.

Autopilot Feature	Available When
Traffic-Aware Cruise Control	<ul style="list-style-type: none"> • You are driving between 30 km/h and 140 km/h <p>NOTE: You can activate Traffic-Aware Cruise Control at lower speeds if there is a vehicle detected at least 1.5 meters ahead of Model X.</p>



Autopilot Features

This topic describes how to enable and use the following driver assistance features.

NOTE: Depending on market region, vehicle configuration, options purchased, and software version, your vehicle may not be equipped with the following features, or a feature may not operate exactly as described.

- **Traffic-Aware Cruise Control:** Like traditional cruise control, Traffic-Aware Cruise Control maintains a set driving speed. However, Traffic-Aware Cruise Control also slows down or accelerates Model X as needed to maintain the following distance from the vehicle in front of you. While Traffic-Aware Cruise Control is engaged, you are still responsible for steering Model X (see [Traffic-Aware Cruise Control on page 114](#)).
- **Auto Lane Change:** When you engage a turn signal while Autosteer is active, Auto Lane Change moves Model X into the adjacent lane in the direction indicated by the turn signal (see [Auto Lane Change on page 114](#)).

These features use information from the cameras on Model X to detect lane markings, road edges, and other vehicles and road users around Model X.

CAUTION: Ensure all cameras are clean and free of obstructions before each drive and before using Autopilot features (see [Cleaning a Camera on page 191](#)). Dirty cameras and sensors (if equipped), as well as environmental conditions such as rain and faded lane markings, can affect Autopilot performance. If a camera is obstructed or blinded, Model X displays a message on the instrument cluster and Autopilot features may not be available.

CAUTION: It is your responsibility to familiarize yourself with the limitations of Autopilot and the situations in which driver intervention may be needed. For more information, see [Limitations and Warnings on page 131](#).

Autopilot Settings

Before you use Autopilot features, customize how they work by touching **Controls > Autopilot**.

- **Set Speed:** Choose whether Autopilot engages at the currently detected speed limit or your current driving speed. Touch **Controls > Autopilot > Set Speed** and choose either **Speed Limit** or **Current Speed**.
- **Offset:** If you choose **Speed Limit**, you can specify an offset by touching **Set Speed Offset**. You can choose **Fixed** (the cruising speed adjusts by a specific amount on all roads) or **Percentage** (the cruising speed is adjusted as a percentage of the road's detected speed limit).

Traffic-Aware Cruise Control

Traffic-Aware Cruise Control is always enabled.

To use Traffic-Aware Cruise Control:

1. To change the set speed, roll the right scroll wheel up to increase, or down to decrease. You can apply the accelerator at any time to temporarily override the set cruising speed. For more information, see [While Using Autopilot on page 115](#).
2. To cancel Traffic-Aware Cruise Control, or press the brake pedal. For more information, see [Canceling Autopilot on page 115](#).

40
MAX

When Traffic-Aware Cruise Control is available but not engaged, the instrument cluster displays the cruising speed in gray. The number shown represents the speed that will be set when you engage Traffic-Aware Cruise Control.

40
MAX

When Traffic-Aware Cruise Control is actively cruising at a set speed, the speed is highlighted with blue text.



WARNING: Traffic-Aware Cruise Control is designed for your driving comfort and convenience and is not a collision warning or avoidance system. It is your responsibility to stay alert, drive safely, and be in control of the vehicle at all times. Never depend on Traffic-Aware Cruise Control to adequately slow down Model X. Always watch the road in front of you and be prepared to take corrective action at all times. Failure to do so can result in serious injury or death. For more information, see [Limitations and Warnings on page 131](#).

Auto Lane Change

NOTE: Depending on market region, vehicle configuration, options purchased, and software version, your vehicle may not be equipped with Auto Lane Change, or the feature may not operate exactly as described.

If you engage a turn signal while Autosteer is active, Model X moves into the adjacent lane in the direction indicated by the turn signal, provided the following conditions are met:

- The turn signal is engaged.
- Lane markings indicate that a lane change is permitted.
- Auto Lane Change detected your hands on the steering wheel.
- Midway through the lane change, Model X must detect the target lane's outside lane marking. If this lane marking is not detected, the lane change is aborted and Model X returns to its original driving lane.
- The view of the camera(s) is not obstructed.
- Model X does not detect a vehicle in its blind spot, or a vehicle or obstacle up to the center of the target lane. If a vehicle or other obstacle is detected in the target lane, it is shown in red in the visualization on the instrument cluster and Model X does not complete the lane change until it is safe to do so.



⚠ WARNING: Although Autopilot is designed to detect vehicles and obstacles in adjacent lanes, it is your responsibility to always perform visual checks to make sure it is safe and appropriate to move into the target lane. If Autopilot cannot change lanes due to inadequate data, the instrument cluster displays a series of warnings. Therefore, when using Auto Lane Change, always pay attention to the instrument cluster and be prepared to manually steer Model X.

The minimum speed at which Autopilot changes lanes may vary depending on region, adjacent lane speeds, and other factors. Always be ready to manually steer and change lanes as necessary. When an automatic lane change is in progress, Overtake Acceleration is activated, allowing Model X to accelerate closer to a vehicle in front (see [Overtake Acceleration on page 116](#)).

When you engage a turn signal, Autopilot moves Model X one lane at a time. Moving into an additional lane requires you to engage the turn signal a second time after the first lane change is complete.

As Model X changes lanes, it is important to monitor its performance by watching the driving path in front of you and the surrounding area. Stay prepared to take over steering at any time. As you are crossing over into the adjacent lane, the instrument cluster displays the location in the lane that Model X is moving into.

Canceling Autopilot

Traffic-Aware Cruise Control cancels when:

- You press the brake pedal.
- You exceed 140 km/h.
- You shift into Reverse, Park, or Neutral.
- A door is opened.
- An Automatic Emergency Braking event occurs (see [Collision Avoidance Assist on page 138](#)).
- The driver's seatbelt is released, and/or the driver gets out of their seat.

When Traffic-Aware Cruise Control cancels, the cruising speed icon on the instrument cluster turns gray to indicate that Traffic-Aware Cruise Control is no longer active.

When Traffic-Aware Cruise Control cancels, Model X does not coast. Instead, regenerative braking slows down Model X in the same way as when you move your foot off the accelerator when driving without Traffic-Aware Cruise Control (see [Regenerative Braking on page 87](#)).

While Using Autopilot

When Traffic-Aware Cruise Control is active and Autopilot is maintaining a set speed, the speed is highlighted with blue text on the instrument cluster.

When Autosteer is active, the steering wheel icon is blue and the lane markings are highlighted in blue on the visualization.

To display more details about the roadway and its surroundings, such as road markings, stop lights, and objects (such as trash cans and poles), touch **Controls > Autopilot > Full Self-Driving Visualization Preview**.

If unable to detect lane markings, Autosteer may determine the driving lane based on a vehicle you are following. In most cases, Autosteer attempts to center Model X in the driving lane. However, there may be situations in which Autosteer follows a driving path that is offset from the center of the lane (for example, if guard rails are detected).

Maintaining the Set Speed

When Autopilot is active, Model X maintains your set cruising speed whenever a vehicle is not detected in front of it. When cruising behind a vehicle, Model X accelerates and decelerates as needed to maintain a chosen following distance (see [Adjusting the Following Distance on page 115](#)), up to the set speed.

You can manually accelerate at any time by pressing the accelerator pedal, but when you release the pedal Model X resumes cruising at the set speed.

Model X also adjusts the cruising speed when entering and exiting curves.

When Model X is actively slowing down to maintain the selected distance from the vehicle ahead, brake lights turn on. You may notice slight movement of the brake pedal. However, when Model X is accelerating, the accelerator pedal does not move.

Changing the Set Speed

Roll the right scroll wheel up to increase, or down to decrease, the set speed.

It may take a few seconds for Model X to reach the new cruising speed.

Adjusting the Following Distance

The closest following distance is 2.

Each setting corresponds to a time-based distance that represents how long it takes for Model X, from its current location, to reach the location of the rear bumper of the vehicle ahead of you. Autopilot retains your setting until you change it again.

Stopping and Slowdowns

When moving significantly faster than vehicles in adjacent lanes, Model X automatically reduces the driving speed. This is especially helpful in heavy traffic situations or when vehicles are constantly merging into different lanes. When Model X detects other vehicles driving significantly slower, the instrument cluster highlights the adjacent lanes with



Autopilot Features

arrows and detected vehicles in gray, and Model X reduces the driving speed as appropriate. To temporarily override this feature, press the accelerator pedal.

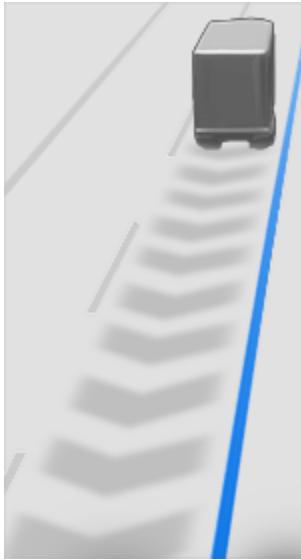

When following a vehicle, Autopilot remains active at low speeds, even when Model X comes to a full stop. For example, Autopilot remains active even if Model X slows down to a complete or near-complete stop in heavy, stop-and-go traffic on a highway. When traffic starts moving more rapidly, Autopilot again accelerates up to the set speed.

Sometimes when Model X is at a full stop, Autopilot goes into a HOLD state. If this happens, briefly press the accelerator pedal to resume cruising.



When the HOLD status is active, the instrument cluster displays the HOLD icon and a message that indicates that you need to resume cruise control.

Model X goes into HOLD state while Autopilot is active in the following circumstances:

- Model X has been at a standstill for 5 minutes.
- Model X detects a pedestrian (the HOLD state may clear when the pedestrian is no longer detected).
- Model X suddenly loses visibility of the vehicle in front of you.
- An obstacle is detected in front of Model X.

Cruising Near or On Exits

When you are cruising near an exit on a controlled-access highway and engage the turn signal toward the off-ramp, Autopilot assumes you are exiting and begins to slow down Model X. If you do not drive onto the off-ramp, Autopilot resumes cruising at the set speed.

In a region with right hand traffic, this occurs only when you engage the right turn signal when driving in the right-most lane within 50 meters of an exit. Likewise in regions with left hand traffic, this occurs when engaging the left turn signal when driving in the left-most lane within 50 meters of an exit.

When cruising onto an on-ramp to a controlled-access highway, Autopilot automatically adjusts the set cruising speed to the speed limit of the highway, plus any offset you have specified.

Overtake Acceleration

Engage the turn signal momentarily to accelerate Model X towards the vehicle ahead of it. By momentarily holding the turn signal, you can quickly accelerate up to your set speed without having to press the accelerator pedal as long as:

- Traffic-Aware Cruise Control is operating and detects a vehicle in front of you.
- No obstacles or vehicles are detected in the target lane.
- Model X is traveling below the set speed, but over 72 km/h.

NOTE: If Autosteer is active and you fully engage the turn signal, Model X will change lanes automatically (see [Auto Lane Change on page 114](#)).

Model X stops accelerating when you reach your set cruising speed, if changing lanes takes too long, or if Model X gets too close the vehicle ahead. Model X also stops accelerating if you disengage the turn signal.

Take Over Immediately

In situations where Autopilot is unable to steer Model X, a warning chime sounds and the instrument cluster displays the following message.



Autosteer is aborting

When you see this message, **take over steering immediately.**

Driver Attentiveness

Autosteer determines how best to steer Model X. When active, Autosteer requires you to hold the steering wheel. If it does not detect your hands on the steering wheel for a period of time, a flashing blue light appears at the top of the vehicle status section of the instrument cluster and the following message displays:



Apply slight turning force to steering wheel

When your hands are detected, the message disappears and Autosteer resumes normal operation. Autosteer detects your hands by recognizing slight resistance as the steering wheel turns, or from you manually turning the steering wheel very lightly (without enough force to take over steering). Autosteer also qualifies your hands as being detected if you engage a turn signal or use a button or scroll wheel on the steering wheel.

Autosteer requires that you pay attention to your surroundings and remain prepared to take control at any time. If Autosteer still does not detect your hands on the steering wheel, the flashing light on the vehicle status section of the instrument cluster increases in frequency and a chime sounds.

If you repeatedly ignore Autosteer's prompts to apply slight force to the steering wheel, Autosteer disables for the rest of the drive and displays the following message requesting you to drive manually.



**Autopilot unavailable for current drive.
Autopilot Strikeout - Attention warnings ignored.**

For the rest of the drive, you must steer manually. Autosteer is available again on your next drive (after you stop and shift Model X into Park).

If you don't resume manual steering, Autosteer sounds a continuous chime, turns on the warning flashers, and slows the vehicle to a complete stop.

Autopilot Suspension

Use of Autopilot features will be suspended if improper usage is detected.

Use of Autosteer is suspended for a week when you or another driver of your vehicle receives three Autopilot "strikeouts." A strikeout is when the Autopilot system disengages for the remainder of a trip after the driver receives several audio and visual warnings for inattentiveness.

You can see how many strikeouts are remaining before Autopilot access is suspended by touching **Controls > Autopilot**.

A strikeout is forgiven after 7 days, as long as you don't receive another strikeout in that time.

NOTE: If your access to Autosteer is suspended, you can still use Traffic-Aware Cruise Control and all active safety features are still enabled.

There may be occasions where driver intervention is required and you must take over immediately to maintain safe driving. Driver-initiated disengagements do not count as improper usage and are expected from the driver.



Traffic-Aware Cruise Control

NOTE: Depending on market region, vehicle configuration, options purchased, and software version, your vehicle may not be equipped with Traffic-Aware Cruise Control, or the feature may not operate exactly as described. If your vehicle is not equipped, refer to the owner's manual on your vehicle's touchscreen for instructions on how to use Cruise Control.

NOTE: Traffic-Aware Cruise Control is a BETA feature.

Traffic-Aware Cruise Control determines when there is a vehicle in front of you in the same lane. If the area in front of Model X is clear, Traffic-Aware Cruise Control maintains a set driving speed. When a vehicle is detected, Traffic-Aware Cruise Control is designed to slow down Model X as needed to maintain a selected time-based distance from the vehicle in front, up to the set speed. Traffic-Aware Cruise Control does not eliminate the need to watch the road in front of you and to manually apply the brakes when needed.

Traffic-Aware Cruise Control is primarily intended for driving on dry, straight roads, such as highways.

CAUTION: Ensure all cameras and sensors (if equipped) are clean before each drive. Dirty cameras and sensors, as well as environmental conditions such as rain and faded lane markings, can affect Autopilot performance.

WARNING: Traffic-Aware Cruise Control is designed for your driving comfort and convenience and is not a collision warning or avoidance system. It is your responsibility to stay alert, drive safely, and be in control of the vehicle at all times. Never depend on Traffic-Aware Cruise Control to adequately slow down Model X. Always watch the road in front of you and be prepared to take corrective action at all times. Failure to do so can result in serious injury or death.

WARNING: Although Traffic-Aware Cruise Control is capable of detecting pedestrians and cyclists, never depend on Traffic-Aware Cruise Control to adequately slow Model X down for them. Always watch the road in front of you and be prepared to take corrective action at all times. Failure to do so can result in serious injury or death.

WARNING: Do not use Traffic-Aware Cruise Control on winding roads with sharp curves, on icy or slippery road surfaces, or when weather conditions (such as heavy rain, snow, fog, etc.) make it inappropriate to drive at a consistent speed. Traffic-Aware Cruise Control does not adapt driving speed based on road and driving conditions.

To Use Traffic-Aware Cruise Control

To initiate Traffic-Aware Cruise Control when no vehicle is detected ahead of you, you must be driving at least 30 km/h, unless certain vehicle and environmental conditions are met, in which case, you may be able to initiate it at lower speeds. If a vehicle is detected ahead of you, you can initiate Traffic-Aware Cruise Control at any speed, even when stationary, provided Model X is at least 1.5 m behind the detected vehicle and certain vehicle and environmental conditions are met.

NOTE: The maximum cruising speed is 150 km/h. It is the driver's responsibility to cruise at a safe speed based on road conditions and speed limits.



When Traffic-Aware Cruise Control is available but not engaged, the instrument panel displays a gray cruising speed icon. The number shown in gray represents the cruising speed that will be set when you engage Traffic-Aware Cruise Control.



When Traffic-Aware Cruise Control is actively cruising at a set cruising speed, the icon turns blue and displays the set cruising speed.

1. When available, you can engage Traffic-Aware Cruise Control to match the speed limit or your current speed. Choose:
 - o To engage Traffic-Aware Cruise Control at your current driving speed, move the Autopilot stalk up or down once and release the accelerator pedal to allow Traffic-Aware Cruise Control to maintain the cruising speed.

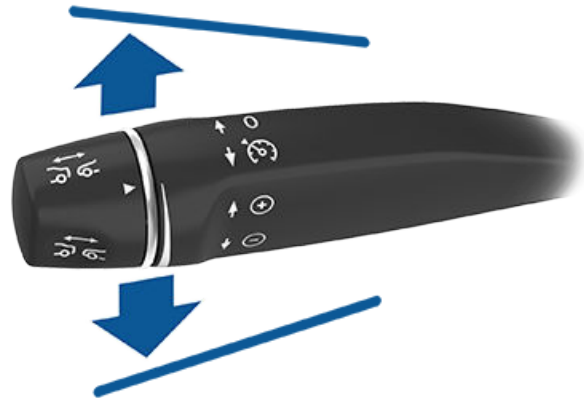

- o To engage Traffic-Aware Cruise Control at the currently detected speed limit, pull the Autopilot stalk toward you once and release the accelerator pedal to allow Traffic-Aware Cruise Control to maintain the cruising speed.

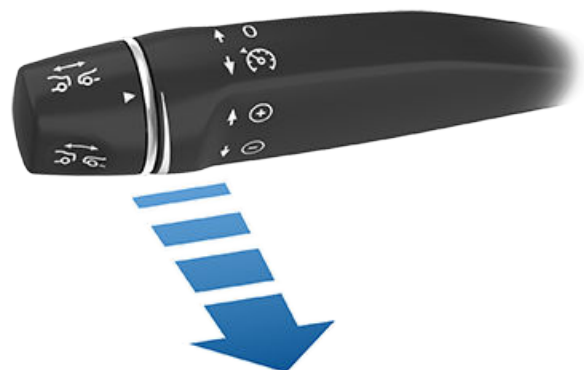



NOTE: If **Autopilot Activation** is set to **Single Pull**, moving the Autopilot stalk toward you once activates Autosteer (see [#unique_73 on page](#)). Touch **Controls > Autopilot > Autopilot Activation** and choose **Double Pull** to use Traffic-Aware Cruise Control independently of Autosteer when you move the Autosteer stalk toward you.

NOTE: If you choose to engage Traffic-Aware Cruise Control at the currently detected speed limit, you can specify an offset. Touch **Controls > Autopilot > Set Speed Offset**. You can choose a **Fixed** offset, in which the cruising speed adjusts by a specific number of km/h on all roads, or a **Percentage** offset, in which the cruising speed is adjusted as a percentage of the road's detected speed limit. If you pull the Autopilot stalk toward you when you are already driving faster than the speed limit, the set speed adjusts to your current driving speed instead of the speed limit. If you move the Autopilot stalk up or down when cruising at the speed limit, your set speed changes to your current driving speed.

A chime sounds to indicate that Traffic-Aware Cruise Control is now active.

WARNING: When you adjust the cruising speed based on the speed limit, the set cruising speed may not change when the speed limit changes.

WARNING: Do not rely on Traffic-Aware Cruise Control or Speed Assist to determine an accurate or appropriate cruising speed. It is the driver's responsibility to cruise at a safe speed based on road conditions and applicable speed limits.

- To change your speed while using Traffic-Aware Cruise Control, you can use the right scroll wheel or the Autopilot stalk. For details, see [Changing the Cruising Speed on page 119](#).
- To cancel Traffic-Aware Cruise Control, push the stalk away from you once or press the brake pedal. See [Canceling and Resuming on page 121](#) for more information.

Changing the Cruising Speed

To change the set cruising speed while using Traffic-Aware Cruise Control, move the Autopilot stalk up (increase) or down (decrease) until the instrument panel icon displays your desired cruising speed.

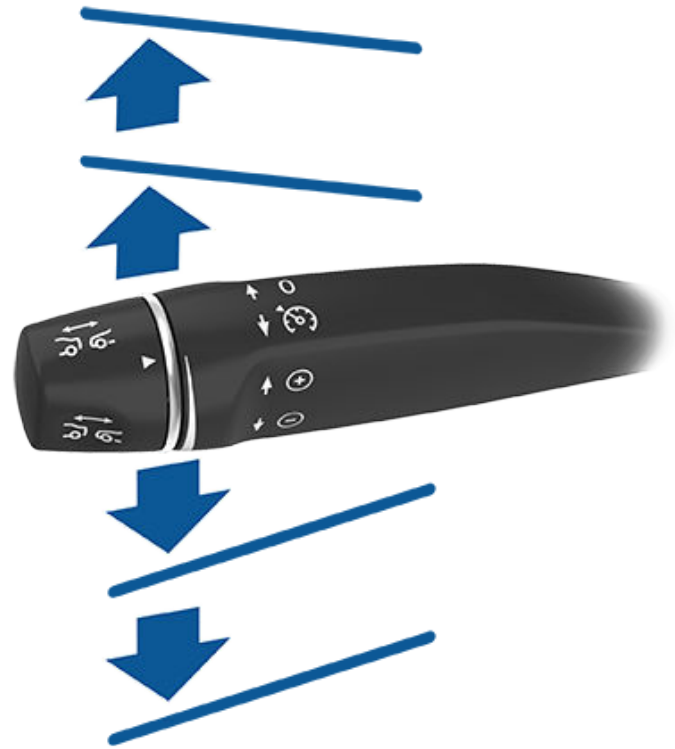

To increase/decrease speed by 1 km/h, move the stalk up or down to the first position and release. To increase/decrease speed to the closest 5 km/h increment, move the stalk up/down to the second position and release. For example, if you are traveling at 83 km/h and you move the stalk up to the second position and release, the speed increases to 85 km/h. You can also increase/decrease speed by holding the stalk in the full up/down position and releasing when the icon on the instrument panel displays your desired cruising speed.

You can also pull and hold the Autopilot stalk towards you for approximately half a second to cruise at the detected speed limit.

NOTE: It may take a few seconds for Model X to reach the new cruising speed, assuming Model X is not cruising behind a vehicle that is driving slower than your set speed.

Cruising at the Set Speed

Traffic-Aware Cruise Control maintains your set cruising speed whenever a vehicle is not detected in front of Model X. When cruising behind a detected vehicle, Traffic-Aware Cruise Control accelerates and decelerates Model X as needed to maintain a chosen following distance (see [Adjust the Following Distance on page 120](#)), up to the set speed.

Traffic-Aware Cruise Control also adjusts the cruising speed when entering and exiting curves.

You can manually accelerate at any time when cruising at a set speed, but when you release the accelerator, Traffic-Aware Cruise Control resumes cruising at the set speed.



Traffic-Aware Cruise Control

NOTE: When Traffic-Aware Cruise Control is actively slowing down Model X to maintain the selected distance from the vehicle ahead, brake lights turn on to alert other road users that you are slowing down. You may notice slight movement of the brake pedal. However, when Traffic-Aware Cruise Control is accelerating Model X, the accelerator pedal does not move.

WARNING: Traffic-Aware Cruise Control may occasionally cause Model X to brake when not required or when you are not expecting it. This can be caused by closely following a vehicle ahead, detecting vehicles or objects in adjacent lanes (especially on curves), etc.

WARNING: Due to limitations inherent in the onboard GPS (Global Positioning System), you may experience situations in which Model X slows down, especially near exits or off-ramps where a curve is detected and/or you are navigating to a destination and not following the route.

WARNING: Traffic-Aware Cruise Control may not detect all objects and, especially when cruising over 80 km/h, may not brake/decelerate when a vehicle or object is only partially in the driving lane or when a vehicle you are following moves out of your driving path and a stationary or slow-moving vehicle or object is in front of you. Always pay attention to the road ahead and stay prepared to take immediate corrective action. Depending on Traffic-Aware Cruise Control to avoid a collision can result in serious injury or death. In addition, Traffic-Aware Cruise Control may react to vehicles or objects that either do not exist, or are not in your lane of travel, causing Model X to slow down unnecessarily or inappropriately.

WARNING: Traffic-Aware Cruise Control may be unable to provide adequate speed control because of limited braking capability and hills. It can also misjudge the distance from a vehicle ahead. Driving downhill can increase driving speed, causing Model X to exceed your set speed (and potentially the road's speed limit). Never depend on Traffic-Aware Cruise Control to slow down Model X enough to prevent a collision. Always keep your eyes on the road when driving and be prepared to take corrective action as needed. Depending on Traffic-Aware Cruise Control to reduce your driving speed enough to prevent a collision can result in serious injury or death.

HOLD State

When following a vehicle, Traffic-Aware Cruise Control remains active at low speeds, even when Model X comes to a full stop. When the vehicle is moving again, Traffic-Aware Cruise Control resumes operating at the set speed. However, under the following circumstances, Traffic-Aware Cruise Control goes into a **HOLD** state, in which case, you need to briefly press the accelerator pedal or pull the Autopilot stalk toward you (see [Canceling and Resuming on page 121](#)) to resume cruising. When the **HOLD** status is active, the instrument panel displays the **HOLD** icon and a message that indicates that you need to resume cruise control. The following circumstances can cause Traffic-Aware Cruise Control to go into the **HOLD** state:

- Model X has been at a standstill for 5 minutes.
- Model X detects a pedestrian (the **HOLD** state may clear when the pedestrian is no longer detected).
- Model X suddenly loses visibility of the vehicle in front of you.
- An obstacle is detected in front of Model X.

Cruising Near or On Exits

When cruising near an exit on a controlled-access highway and engaging the turn signal toward the off-ramp, Traffic-Aware Cruise Control assumes you are exiting and begins to slow down Model X. If you do not drive onto the off-ramp, Traffic-Aware Cruise Control resumes cruising at the set speed. In a region with right hand traffic, this occurs only when you engage the right turn signal when driving in the right-most lane within 50 meters of an exit. Likewise in regions with left hand traffic; when engaging the left turn signal when driving in the left-most lane within 50 meters of an exit.

When cruising onto an on-ramp to a controlled-access highway, Traffic-Aware Cruise Control automatically adjusts the set cruising speed to the speed limit of the highway, plus any offset you have specified.

NOTE: The on-board Global Positioning System (GPS) determines if you are driving in a region with right or left hand traffic. In situations where GPS data is unavailable (for example, if there is inadequate signal), engaging the turn signal near an exit does not cause Traffic-Aware Cruise Control to slow down Model X.

Adjust the Following Distance

To adjust the following distance you want to maintain between Model X and a vehicle traveling ahead of you, rotate the Autopilot stalk. Each setting corresponds to a time-based distance that represents how long it takes for Model X, from its current location, to reach the location of the rear bumper of the vehicle ahead of you. Your setting is retained until you manually change it.

The closest following distance is 2.



As you rotate the Autopilot stalk, the instrument panel displays the current setting. Release the stalk when the desired setting is displayed.



WARNING: It is the driver's responsibility to determine and maintain a safe following distance at all times. Do not rely on Traffic-Aware Cruise Control to maintain an accurate or appropriate following distance.

WARNING: Never depend on Traffic-Aware Cruise Control to adequately slow down Model X to avoid a collision. Always watch the road in front of you and stay prepared to take immediate corrective action.

Overtake Acceleration

When following a vehicle with Traffic-Aware Cruise Control active, engaging the turn signal (to indicate a move into the passing lane) accelerates Model X towards the vehicle ahead. By momentarily holding the turn signal stalk up or down, you can quickly accelerate up to your set speed without having to press the accelerator pedal. The turn signal causes acceleration only when all of the following conditions are met:

- Traffic-Aware Cruise Control is operating and detects a vehicle in front of you.
- No obstacles or vehicles are detected in the target lane.
- Model X is traveling below the set speed, but over 72 km/h.

Overtake Acceleration is intended as an aid when passing a vehicle ahead of you. When the turn signal is engaged, Traffic-Aware Cruise Control continues to maintain distance from the vehicle ahead, but allows you to drive slightly closer than your selected distance.

Acceleration cancels when one of the conditions happen:

- You reach your set cruising speed.
- Changing lanes takes too long.
- Model X gets too close to the vehicle ahead.

OR

- You disengage the turn signal.

NOTE: Overtake Acceleration occurs when you fully engage the turn signal, or you . When you release the turn signal, Model X stops accelerating (in the same way as when you release the accelerator pedal) and resumes the set speed.

WARNING: Overtake Acceleration can cancel for many unforeseen reasons in addition to those listed above (for example, lack of GPS data). Stay alert and never depend on Overtake Acceleration to increase your driving speed.

WARNING: Overtake Acceleration increases your driving speed whenever the appropriate turn signal is engaged, and accelerates Model X closer to the vehicle ahead. Although Traffic-Aware Cruise Control continues to maintain distance from the vehicle ahead, it is important to be aware that your selected following distance is reduced when Overtake Acceleration is active, particularly in cases where it may not be your intention to overtake the vehicle you are following.

Canceling and Resuming

To manually cancel Traffic-Aware Cruise Control, press the brake pedal or briefly push the Autopilot stalk away from you. The cruising speed icon on the instrument panel turns gray to indicate that Traffic-Aware Cruise Control is no longer active.



To resume cruising at the previously set speed, briefly pull the Autopilot stalk toward you.

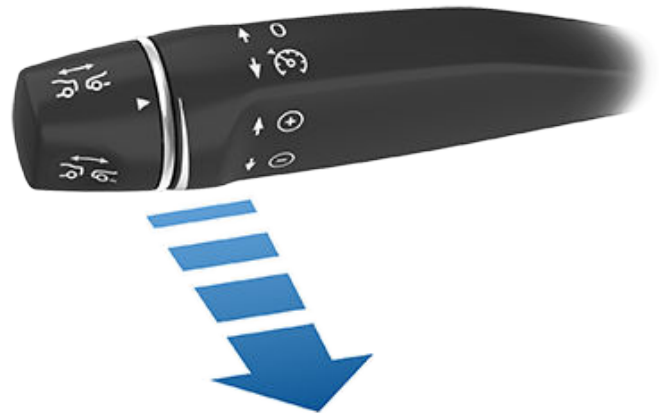

To resume cruising at the current driving speed, move the Autopilot stalk up or down, then release.



Traffic-Aware Cruise Control

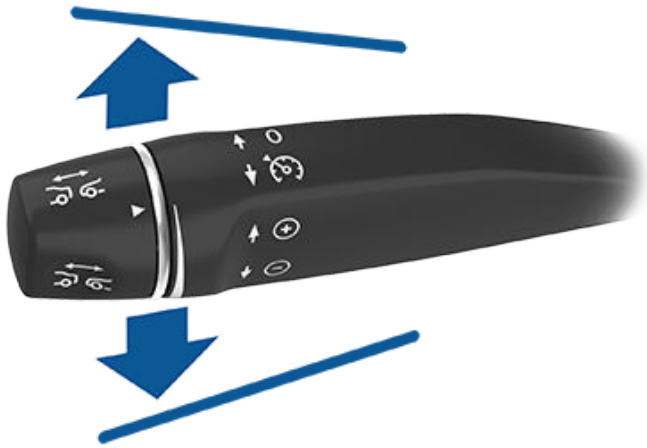

Traffic-Aware Cruise Control is actively cruising and is either maintaining the set speed (no vehicle in front) or is maintaining a chosen following distance from a vehicle ahead (up to the set speed).



Model X has fully stopped but is in a **HOLD** state. If safe, press the accelerator pedal to resume cruising at the set speed.

NOTE: When Traffic-Aware Cruise Control cancels, Model X does not coast. Instead, regenerative braking slows down Model X in the same way as when you move your foot off the accelerator when driving without Traffic-Aware Cruise Control (see [Regenerative Braking on page 87](#)).

WARNING: Traffic-Aware Cruise Control cancels, or may not be available, in the following situations:

- You press the brake pedal.
- Your driving speed exceeds the maximum cruising speed of 150 km/h.
- You shift Model X.
- A door is opened.
- A camera or sensor (if equipped) is obstructed. This could be caused by dirt, mud, ice, snow, fog, etc.
- The traction control setting is manually disabled or is repeatedly engaging to prevent wheels from slipping.
- The wheels are spinning while at a standstill.
- The Traffic-Aware Cruise Control system is failing or requires service.

When Traffic-Aware Cruise Control is unavailable or cancels, Model X no longer drives consistently at a set speed and no longer maintains a specified distance from the vehicle ahead.

WARNING: Traffic-Aware Cruise Control can cancel unexpectedly at any time for unforeseen reasons. Always watch the road in front of you and stay prepared to take appropriate action. It is the driver's responsibility to be in control of Model X at all times.

Limitations

Traffic-Aware Cruise Control is particularly unlikely to operate as intended in the following types of situations:

- The road has sharp curves.
- Visibility is poor (due to heavy rain, snow, fog, etc.).
- Bright light (such as from oncoming headlights or direct sunlight) is interfering with the view of the camera(s).
- A camera or sensor (if equipped) is obstructed (fogged over, dirty, covered by a sticker, etc.).

WARNING: The list above does not represent an exhaustive list of situations that may interfere with proper operation of Traffic-Aware Cruise Control.

Summary of Cruise Indicators



Traffic-Aware Cruise Control is available but is not actively controlling your speed until you activate it. The number shown in gray is the cruising speed that will be set when you engage Traffic-Aware Cruise Control.

NOTE: Depending on market region, vehicle configuration, options purchased, and software version, your vehicle may not be equipped with Autopark.

Autopark uses data to simplify parking on public roads by maneuvering Model X into parallel and perpendicular parking spaces.

NOTE: Autopark is unavailable when Traffic-Aware Cruise Control is enabled. To use Autopark, enable Autosteer by touching **Controls > Autopilot**.

If your access to Autosteer is suspended, you also lose access to Autopark. For more information, see [Autopilot Suspension on page 117](#).

WARNING: It is your responsibility to familiarize yourself with the limitations of Autopark and the situations in which it may not work as expected. For more information, see [Limitations and Warnings on page 131](#).

CAUTION: Do not use Autopark if anything, such as a ball hitch, bike rack, or trailer, is attached to the tow hitch. Autopark may not stop for hitches when parking between or in front of other vehicles.

CAUTION: Autopark's performance depends on the ability of the cameras to determine the vehicle's proximity to curbs, objects, and other vehicles. Ensure all cameras are clean and free of obstructions before each drive and before using Autopilot features (see [Cleaning a Camera on page 191](#)). Dirty cameras and sensors (if equipped), as well as environmental conditions such as rain and faded lane markings, can affect Autopilot performance. If a camera is obstructed or blinded, Model X displays a message on the instrument cluster and Autopilot features may not be available.

Parameters

Autopark detects potential parking spaces based on the following parameters:

Perpendicular Parking

- Your driving speed must be below 13 km/h. If driving too fast, Autopark may not be able to accurately detect your desired parking space.
- The parking space must be at least as wide as your vehicle.
- The parking space must have at least three visible lines for the vehicle to park into, such as parking lines, road markings, or distinct curbs. Autopark may not work in a garage, for example, without three visible parking lines.
- Autopark may not work with textured road surfaces such as cobblestone or brick.

Parallel Parking

- Your driving speed must be below 13 km/h. If driving too fast, Autopark may not be able to accurately detect your desired parking space.
- There must be a vehicle in front of or behind the space you want to park in.

NOTE: Autopark does not operate on angled parking spaces.

To Use Autopark

When driving, follow these steps to allow Autopark to maneuver Model X into a parking space:

1. While driving slowly, monitor the instrument cluster (after making sure that it is safe to do so) to see potential parking spaces detected by Autopilot.

NOTE: The detected parking spaces appear only if the vehicle's position and/or the circumstances of the surrounding area are such that Autopark can determine an appropriate driving path. If Autopark cannot determine an appropriate path (for example, when driving on a narrow street where moving into the parking space causes the front of the vehicle to extend into the adjacent lane), you can either reposition the vehicle, find a different parking space, or park manually.



2. Move the right scroll wheel up or down to select a parking space. When ready to park, press the right scroll button and release the steering wheel.
3. Autopark displays a message when parking is complete.

If you press the brake pedal when Autopark is actively parking Model X, the parking process cancels.

CAUTION: Model X does not brake if you choose to override the current speed by pressing the accelerator pedal while Autopark is active. In this case, Autopark cancels if you exceed 10 km/h.



⚠ WARNING: Never depend on Autopark to find a parking space that is legal, suitable, and safe. Autopark may not always detect objects in the parking space. Always perform visual checks to confirm that a parking space is appropriate and safe.

⚠ WARNING: When Autopark is actively steering Model X:

- Do not interfere with the movement of the steering wheel. Doing so cancels Autopark.
- Continually check your surroundings. Be prepared to apply the brakes to avoid vehicles, pedestrians, or objects.
- Monitor the touchscreen to ensure that you are aware of the instructions that Autopark is providing.

To Cancel Parking

Autopark cancels the parking sequence when:

- You manually move the steering wheel.
- You shift.
- You press the brake pedal.
- You press the right scroll button on the steering wheel.
- The parking sequence exceeds seven moves.

Take Over Immediately

In situations where Autopark is unable to steer Model X, Autopark sounds a warning chime and displays the message **Take Over Immediately**.

This happens when:

- Model X detects that a door is opened or that the driver is exiting the vehicle.
- One or more of the cameras is damaged, dirty, obstructed (such as by mud, ice, or snow, or by adhesive products such as wraps, stickers, etc.), or has poor visibility (due to heavy rain, snow, hail, etc. or poor lighting).
- Your speed exceeds 10 km/h.
- An Automatic Emergency Braking event occurs (see [Collision Avoidance Assist on page 138](#)).

When you see this message, **take over immediately**.

NOTE: Depending on market region, vehicle configuration, options purchased, and software version, your vehicle may not be equipped with Summon, or the feature may not operate exactly as described.

Summon allows you to automatically park and retrieve Model X while you are standing outside the vehicle. Summon moves Model X forward and reverse up to 12 meters in, or out of, a parking space.

To move Model X a longer distance while steering around objects, you can use Smart Summon (if equipped) and your mobile phone. Smart Summon allows your vehicle to find you (or you can send your vehicle to a chosen location). See [Smart Summon on page 128](#).

Summon requires that Model X can detect a valid key nearby.

 **CAUTION:** Ensure all cameras and sensors (if equipped) are clean. Dirty cameras and sensors, as well as environmental conditions such as rain and faded lane markings, can affect Autopilot performance.

 **WARNING:** Summon is designed and intended for use only on parking lots and driveways on private property where the surrounding area is familiar and predictable.

 **WARNING:** Summon is a BETA feature. You must continually monitor the vehicle and its surroundings and stay prepared to take immediate action at any time. It is the driver's responsibility to use Summon safely, responsibly, and as intended.

 **WARNING:** Summon's performance depends on the ability of the cameras and sensors (if equipped) to determine the vehicle's proximity to objects, people, animals, and other vehicles.

Before Using Summon

Before operating Summon, use the touchscreen to enable it and customize how you want it to work. Touch **Controls** > **Autopilot** > **Customize Summon** and adjust the following settings to suit your preferences:

- **Bumper Clearance:** Set the distance that you want Summon to stop from a detected object (for example, you may want Summon to stop within just a few inches of a garage wall). Note that this distance applies only to objects that Summon detects directly in front of Model X when moving forward, or directly behind Model X when reversing.
- **Summon Distance:** Set a maximum distance that Model X can travel when entering or exiting a parking space.
- **Side Clearance:** Choose an option to specify how much side clearance you want to allow. **Tight** allows Model X to enter and exit very narrow parking spaces.

 **WARNING:** Parking in a narrow space limits the ability of the cameras and sensors (if equipped) to accurately detect the location of obstacles, increasing the risk of damage to Model X and/or surrounding objects.

- **Require Continuous Press:** By default, Summon requires that you press and hold a button on the mobile app to move Model X during the parking process. When **Require Continuous Press** is set to **No**, you can press and release the button—you don't need to hold it down to keep the vehicle moving. Also, when **Require Continuous Press** is set to **No**, you can operate Summon using the key fob instead of the mobile app (see [Operating Summon with the Key Fob on page 126](#)) and you can start a parking sequence from inside the vehicle (see [Starting Summon Before Exiting the Vehicle on page 126](#)).

NOTE: The above settings, apply only to Summon—not Smart Summon (if equipped) (see [Before Using Smart Summon on page 128](#)). You cannot customize Smart Summon's bumper clearance, distance, and side clearance. And when using Smart Summon, you must always hold down the button on the mobile app to keep Model X moving. Also, Smart Summon operates with the mobile app only—not the key fob.

NOTE: All settings are retained until you manually change them.

Using Summon to Park and Retrieve your Vehicle

Follow these steps to use Summon to park your Model X:

- Align Model X within 12 meters of the parking space so Model X can follow a straight path into or out of the space in either Drive or Reverse.
- From outside the vehicle, initiate the parking maneuver by touching **Summon** on the mobile app, then holding down the **Forward** or **Reverse** button.

NOTE: If the **Require Continuous Press** setting is **No**, you do not need to hold down the button, just press and release.

NOTE: You can also initiate the parking maneuver from inside the vehicle (see [Starting Summon Before Exiting the Vehicle on page 126](#)).

Summon shifts Model X into Drive or Reverse (based on the direction you specified) and drives into or out of the parking space. When parking is complete, or if an obstacle is detected, Summon shifts Model X into Park. Summon shifts Model X into Park when:

- Model X detects an obstacle in its driving path (within the **Bumper Clearance** setting that you specified).
- Summon has moved Model X the maximum distance of 12 meters.
- You release the **Forward** or **Reverse** button (when **Require Continuous Press** is turned on).
- You press any button to manually stop Summon.

If you used Summon to park Model X, you can then use Summon to return Model X back to its original position (provided Model X has remained in Park), or to the maximum **Summon Distance** that you have specified (whichever comes first). Simply specify the opposite direction on the mobile app and Summon moves Model X along the original path, provided no obstructions have been introduced. If an obstacle is detected, Model X attempts to avoid the obstacle while staying very close to its original path (Summon does not steer around obstacles).

NOTE: To use Summon to move Model X multiple times in the same direction (not to exceed the maximum of 12 meters, cancel Summon and then restart the parking process using the same direction.

NOTE: Although Summon can move Model X a short distance laterally to avoid an obstacle, it does not attempt to steer around an obstacle to return Model X to its original driving path. Only Smart Summon (if equipped) can steer Model X around objects.

NOTE: Summon requires that Model X can detect a valid key nearby.

WARNING: Model X cannot detect obstacles that are located lower than the bumper, are very narrow, or are hanging from a ceiling (for example, bicycles). In addition, many unforeseen circumstances can impair Summon's ability to move in or out of a parking space and, as a result, Summon may not move Model X appropriately. Therefore, you must continually monitor the vehicle's movement and its surroundings and remain prepared to stop Model X at any time.

Operating Summon with the Key Fob

NOTE: Summon may not operate if the battery is low on the key fob.

Follow these steps to park Model X from outside the vehicle using the key fob:

1. On the touchscreen, ensure that **Require Continuous Press** is disabled (touch **Controls > Autopilot > Customize Summon > Require Continuous Press**).
2. With Model X in Park, stand within three meters and press and hold the top center button on the key fob (Lock/Unlock All button) until the hazard lights blink continuously.
NOTE: The hazard lights flash once as Model X locks, then within five seconds, Model X powers on and the hazard lights flash continuously. Do not proceed to the next step until the hazard lights are flashing. If, after five seconds, the hazard lights are not flashing, release the button on the key fob, move closer to Model X, and try again. If Summon receives no further input within ten seconds, Summon cancels.
3. Press the Front Trunk button on the key fob to move Model X forward into the parking space, or press the Rear Trunk button to reverse Model X into the parking space.

Starting Summon Before Exiting the Vehicle

To start a Summon parking sequence before exiting Model X:

1. On the touchscreen, ensure that **Require Continuous Press** is disabled (touch **Controls > Autopilot > Customize Summon > Require Continuous Press**).
2. Close all doors and trunks.
3. With Model X powered on and Park engaged, double press the Park button on the drive stalk. The touchscreen displays a popup screen.
4. On the touchscreen, choose the direction of travel.
5. Exit Model X and close the driver's door.

Summon now moves Model X according to the direction you specified on the touchscreen.

NOTE: To cancel the parking maneuver before exiting the vehicle, touch **Cancel** on the popup screen.

NOTE: If you do not choose a direction of travel on the touchscreen, Summon does not start a parking maneuver when you exit.

Stopping or Canceling Summon

Stop Model X at any time while Summon is active by using the mobile app or by pressing any button on the key fob. Summon also cancels when:

- A door handle is engaged or a door is opened.
- You interact with the steering wheel, brake pedal, accelerator pedal, or shift.
- Model X detects an obstacle.
- Summon has moved Model X the maximum distance of approximately 12 meters.
- Your phone enters sleep mode or loses connectivity to Model X.

Limitations

Summon is unlikely to operate as intended in the following types of situations:

- The driving path is sloped. Summon is designed to operate on flat roads only (up to 10% grade).
- A raised concrete edge is detected. Summon does not move Model X over an edge that is higher than approximately 2.5 cm.
- One or more of the sensors (if equipped) or cameras is damaged, dirty, or obstructed (such as by mud, ice, or snow, or by a vehicle bra, excessive paint, or adhesive products such as wraps, stickers, rubber coating, etc.).
- Weather conditions (heavy rain, snow, fog, or extremely hot or cold temperatures) are interfering with sensor operation.

- The sensors (if equipped) are affected by other electrical equipment or devices that generate ultrasonic waves.
- Model X is in Trailer Mode or an accessory is attached.

NOTE: Summon is disabled if Model X is in Valet mode (see [Valet Mode on page 98](#)).

 **WARNING:** The list above does not represent an exhaustive list of situations that may interfere with proper operation of Summon. It is the driver's responsibility to remain in control of Model X at all times. Pay close attention whenever Summon is actively moving Model X and stay prepared to take immediate action. Failure to do so can result in serious property damage, injury or death.



Smart Summon

NOTE: Depending on market region, vehicle configuration, options purchased, and software version, your vehicle may not be equipped with Smart Summon, or the feature may not operate exactly as described.

Smart Summon is designed to allow you to move Model X to your location (using your phone's GPS as a target destination) or to a location of your choice, maneuvering around and stopping for objects as necessary. Smart Summon works with the Tesla mobile app when your phone is located within approximately 65 meters of Model X.

Smart Summon maneuvers Model X out of parking spaces and around corners. This is useful for moving Model X out of a tight parking spot, through puddles, or helping you retrieve your car while carrying packages. You must maintain a clear line of sight between you and Model X and closely monitor the vehicle and its surroundings at all times.

CAUTION: Ensure all cameras and sensors (if equipped) are clean. Dirty cameras and sensors, as well as environmental conditions such as rain and faded lane markings, can affect Autopilot performance.

WARNING: Smart Summon is designed and intended for use only on parking lots and driveways located on private property where the surrounding area is familiar and predictable. Do not use Smart Summon on public roads.

WARNING: Smart Summon must only be used on paved surfaces.

WARNING: Smart Summon is a BETA feature. You must continually monitor the vehicle and its surroundings and stay prepared to take immediate action at any time. It is the driver's responsibility to use Smart Summon safely, responsibly, and as intended.

WARNING: Smart Summon may not stop for all objects (especially very low objects such as some curbs, or very high objects such as a shelf) and may not react to all traffic. Smart Summon does not recognize the direction of traffic, does not navigate around empty parking spaces, and may not anticipate crossing traffic.

WARNING: Smart Summon's performance depends on the sensors (if equipped), the visibility of the cameras, and the availability of an adequate cellular signal and GPS data.

WARNING: When using Smart Summon, you must maintain a clear line of sight between you and Model X and stay prepared to stop the vehicle at any time by releasing the button on the mobile app.

Before Using Smart Summon

- Download the latest version of the Tesla mobile app to your phone, and ensure your phone has cellular service and GPS enabled.
- Your phone must be connected to Model X and located within approximately 65 meters.

- The vehicle's cameras must be fully calibrated (see [Drive to Calibrate Cameras on page 19](#)).
- You must have a clear line of sight to Model X.
- Model X must be in Park, not charging, and all doors and trunks must be closed.

Using Smart Summon

1. Open the Tesla mobile app, and press **Summon**.
2. Press the **Smart Summon** icon located in the center of the image of your Model X. It may take several seconds for Smart Summon to start up.

NOTE: You can use Standby Mode to eliminate the delay that occurs when Smart Summon is starting up (see [Standby Mode on page 129](#)).

The mobile app displays a map with a blue circle, which represents the maximum proximity of 65 meters that you must maintain between your phone and Model X. The blue dot on the map represents your location, and the red arrow represents the vehicle.

3. Position yourself anywhere within the blue circle where you have a clear line of sight to Model X.
4. You can now operate Smart Summon using either of these modes:
 - **Come to Me** mode: Press and hold the **Come to Me** button. Model X moves to your GPS location. As you move, Model X follows you. When Model X reaches you, it stops and shifts into park.
 - **Go to Target** mode: Touch the crosshair icon then drag the map to position the pin on a chosen destination. Press and hold the **Go to Target** button. Model X moves to the destination. When reaching the location, Model X stops and shifts into Park and the mobile app displays a message indicating that Summon has completed.

NOTE: To subsequently change the location, lift your finger, reposition the map, then press and hold **Go to Target** again.

To stop Model X at any time, simply release the **Come to Me** or **Go to Target** button.



The map's crosshair icon toggles between **Go to Target** and **Come to Me** modes. When **Come to Me** mode is selected, the icon is blue.

NOTE: The map also has an icon that allows you to display/hide satellite imagery.

Immediately after initiating Smart Summon in either mode, hazard lights briefly flash, mirrors fold, and Model X shifts into Drive or Reverse. Model X then slowly moves to within 1 meter of you (**Come to Me**) or your chosen destination (**Go to Target**), navigating obstacles as needed. As Model X moves,



the corresponding red arrow on the map also moves to show the vehicle's location. As you move, the corresponding blue dot also moves to show your location.

In either mode, Model X stops moving and shifts into park when:

- You release the button on the mobile app.
- The maximum proximity between your phone and Model X is exceeded (if moving the vehicle to a destination away from you, you may need to follow the car to maintain this distance).
- The driving path is blocked.
- Model X has moved the maximum distance of 145 meters since the start of the Smart Summon session, or has moved 150 meters away from the location from which the vehicle was last driven manually.

NOTE: If Smart Summon moves Model X forward 3 meters and then backwards 2 meters, this is considered 5 meters of travel.

NOTE: There is no need to look at the mobile app—just hold down the button while keeping your eye on Model X and its driving path at all times, remaining ready to release the button to stop the vehicle if needed.

If equipped and Auto HomeLink is enabled for Summon (touch **Controls** > **Autopilot** > **Customize Summon** > **Use Auto HomeLink**), Smart Summon automatically opens a HomeLink device if you start the Smart Summon maneuver when Model X is located inside a garage. The mobile app informs you that the door has opened.

WARNING: When you release the button to stop Model X, a slight delay occurs before the vehicle stops. Therefore, it is critical that you pay close attention to the vehicle's driving path at all times and proactively anticipate obstacles that the vehicle may be unable to detect.

WARNING: Use extreme caution when using Smart Summon in environments where movement of obstacles can be unpredictable. For example, where people, children or animals are present.

WARNING: Smart Summon may not stop for all objects (especially very low objects such as some curbs, or very high objects such as a shelf) and may not react to all oncoming or side traffic. Pay attention and be ready to stop Model X at all times by releasing the button on the mobile app.

Standby Mode

To keep Model X ready to Summon and reduce the time it takes to warm up, turn on Standby Mode. Touch **Controls** > **Autopilot** > **Standby Mode**. When Standby Mode is turned on, you can conserve Battery energy by disabling Standby Mode at these locations:

- **Exclude Home** - Disables Standby Mode at the location you set as Home in your Favorites list.
- **Exclude Work** - Disables Standby Mode at the location you set as Work in your Favorites list.
- **Exclude Favorites** - Disables Standby Mode at any location in your Favorites list.

NOTE: To conserve energy, Smart Summon automatically exits Standby mode from midnight to 6:00 am. During these hours, a delay occurs as Smart Summon starts up.

NOTE: Additional battery power may be consumed while Standby Mode is active.

NOTE: For details on how to designate a location as Home, Work, or Favorites, see [Home, Work, and Favorite Destinations on page 160](#).

Stopping or Canceling Smart Summon

Smart Summon stops Model X whenever you release the button on the mobile app. To resume the Smart Summon session, simply press the **Come to Me** or **Go to Target** button again.



WARNING: Always anticipate when you need to stop Model X. Depending on the quality of the connectivity between the phone and Model X, there may be a slight delay between when you release the button and when the car stops.

Smart Summon cancels, and requires you to restart it, when:

- You press any button on the key fob.
- A door handle is engaged or a door is opened.
- You interact with the steering wheel, brake pedal, accelerator pedal, or shift.
- Model X is blocked by an obstacle.
- Smart Summon has moved Model X the maximum distance. To move further than this distance, you must shift Model X into Drive or Reverse and then re-initiate a Smart Summon session.
- Your phone enters sleep mode or loses connectivity to Model X.

Limitations

Smart Summon is unlikely to operate as intended in the following types of situations:

- GPS data is unavailable due to poor cellular coverage.
- The driving path is sloped. Smart Summon is designed to operate on flat roads only (up to 10% grade).
- A raised concrete edge is detected. Depending on the height of the concrete edge, Smart Summon may not move Model X over it.



Smart Summon

- One or more of the sensors (if equipped) or cameras is damaged, dirty, or obstructed (such as by mud, ice, or snow, or by a vehicle bra, excessive paint, or adhesive products such as wraps, stickers, rubber coating, etc.).
- Weather conditions (heavy rain, snow, fog, or extremely hot or cold temperatures) are interfering with sensor (if equipped) or camera operation.
- The sensors (if equipped) are affected by other electrical equipment or devices that generate ultrasonic waves.
- Model X is in Trailer Mode or an accessory is attached.

NOTE: Smart Summon is disabled if Model X is in Valet mode (see [Valet Mode on page 98](#)).



WARNING: The list above does not represent an exhaustive list of situations that may interfere with proper operation of Smart Summon. It is the driver's responsibility to remain in control of Model X at all times. Pay close attention whenever Smart Summon is actively moving Model X and stay prepared to take immediate action. Failure to do so can result in serious property damage, injury or death.



This topic includes warnings, cautions, and limitations pertaining to the following Autopilot features.

- [Traffic-Aware Cruise Control on page 118](#)
- [Autopark on page 132](#)
- [Summon on page 125](#)
- [Smart Summon on page 128](#)

NOTE: Depending on market region, vehicle configuration, options purchased, and software version, your vehicle may not be equipped with all features listed above, or a feature may not operate as described.

 **WARNING:** Read the following warnings and limitations carefully before using Autopilot. Failure to follow all warnings and instructions can result in property damage, serious injury, or death.

NOTE: Ensure all cameras are clean and free of obstructions before each drive and before using Autopilot features (see [Cleaning a Camera on page 191](#)). Dirty cameras and sensors (if equipped), as well as environmental conditions such as rain and faded lane markings, can affect Autopilot performance. If a camera is obstructed or blinded, Model X displays a message on the instrument cluster and Autopilot features may not be available.

Traffic-Aware Cruise Control

While using Traffic-Aware Cruise Control, **it is the driver's responsibility to stay alert, drive safely, and be in control of the vehicle at all times.** Always keep your eyes on the road when driving and be prepared to take corrective action as needed.

In addition, it is the driver's responsibility to cruise at a safe speed and maintain a safe following distance based on road conditions and applicable speed limits. Be aware of the following limitations while Traffic-Aware Cruise Control is active.

- There may be situations where the cruising speed may not change when the speed limit changes.
- Traffic-Aware Cruise Control does not adapt driving speed based on road and driving conditions. Do not use Traffic-Aware Cruise Control on winding roads with sharp curves, on icy or slippery road surfaces, or when weather conditions (such as heavy rain, snow, fog, etc.) make it inappropriate to drive at a consistent speed.
- Do not rely on Traffic-Aware Cruise Control to maintain an accurate or appropriate following distance.
- Traffic-Aware Cruise Control may be unable to provide adequate speed control because of limited braking capability and hills. It can also misjudge the distance from a vehicle ahead. Driving downhill can increase driving speed, causing Model X to exceed your set speed (and potentially the road's speed limit).

- Traffic-Aware Cruise Control may occasionally cause Model X to brake when not required or when you are not expecting it. This can be caused by closely following a vehicle ahead, detecting vehicles or objects in adjacent lanes (especially on curves), etc.
- Due to limitations inherent in the onboard GPS (Global Positioning System), you may experience situations in which Model X slows down, especially near exits or off-ramps where a curve is detected and/or you are navigating to a destination and not following the route.
- In some cases (such as having insufficient data), Traffic-Aware Cruise Control may not automatically reduce the set speed on the highway interchange or off-ramp.
- Traffic-Aware Cruise Control may not detect all objects and, especially when cruising over 80 km/h, may not brake/decelerate when a vehicle or object is only partially in the driving lane or when a vehicle you are following moves out of your driving path and a stationary or slow-moving vehicle or object is in front of you.
- Traffic-Aware Cruise Control may react to vehicles or objects that either do not exist, or are not in your lane of travel, causing Model X to slow down unnecessarily or inappropriately.

 **WARNING:** Traffic-Aware Cruise Control is particularly unlikely to operate as intended in the following types of situations:

- The road has sharp curves or significant changes in elevation.
- Road signs and signals are unclear, ambiguous, or poorly maintained.
- Visibility is poor (due to heavy rain, snow, hail, etc. or poorly lit roadways at night)
- You are driving in a tunnel or next to a highway divider that interferes with the view of the camera(s)
- Bright light (such as from oncoming headlights or direct sunlight) interferes with the view of the camera(s).

 **WARNING:** The list above does not represent an exhaustive list of situations that may interfere with proper operation of Traffic-Aware Cruise Control. Traffic-Aware Cruise Control can cancel unexpectedly at any time for unforeseen reasons. Always watch the road in front of you and stay prepared to take appropriate action. It is the driver's responsibility to be in control of Model X at all times.

 **WARNING:** Traffic-Aware Cruise Control is designed for your driving comfort and convenience and is not a collision warning or avoidance system. Never depend on Traffic-Aware Cruise Control to adequately slow down Model X. Always watch the road in front of you and be prepared to take corrective action at all times. Failure to do so can result in serious injury or death.



Limitations and Warnings

WARNING: Although Traffic-Aware Cruise Control is capable of detecting pedestrians and cyclists, never depend on Traffic-Aware Cruise Control to adequately slow Model X down for them. Failure to do so can result in serious injury or death.

Autopark

CAUTION: Autopark's performance depends on the ability of the cameras and sensors (if equipped) to determine the vehicle's proximity to curbs, objects, and other vehicles. Be aware of the following warnings before and while using Autopark:

- Do not use Autopark if anything, such as a ball hitch, bike rack, or trailer, is attached to the tow hitch. Autopark may not stop for hitches when parking between or in front of other vehicles.
- Never depend on Autopark to find a parking space that is legal, suitable, and safe. Autopark may not always detect objects in the parking space. Always perform visual checks to confirm that a parking space is appropriate and safe.
- When Autopark is actively steering Model X, the steering wheel moves in accordance with Autopark's adjustments. Do not interfere with the movement of the steering wheel. Doing so cancels Autopark.
- During the parking sequence, continually check your surroundings. Be prepared to apply the brakes to avoid vehicles, pedestrians, or objects.
- When Autopark is active, monitor the touchscreen to ensure that you are aware of the instructions that Autopark is providing.

CAUTION:

Autopark is particularly unlikely to operate as intended in these situations:

- The road is sloped. Autopark is designed to operate on flat roads only.
- Visibility is poor (due to heavy rain, snow, fog, etc.).
- The curb is constructed of material other than stone, or the curb cannot be detected.
- The target parking space is directly adjacent to a wall or pillar (for example, the last parking space of a row in an underground parking structure).
- One or more of the sensors (if equipped) or cameras is damaged, dirty, or obstructed (such as by mud, ice, or snow, or by a vehicle bra, excessive paint, or adhesive products such as wraps, stickers, rubber coating, etc.).
- Weather conditions (heavy rain, snow, fog, or extremely hot or cold temperatures) are interfering with sensor (if equipped) operation.
- The sensors (if equipped) are affected by other electrical equipment or electrical interference.

WARNING: Many unforeseen circumstances can impair Autopark's ability to park Model X. Keep this in mind and remember that as a result, Autopark may not steer Model X appropriately. Pay attention when parking Model X and stay prepared to immediately take control.



Summon

-  **CAUTION:** Summon's performance depends on the ability of the cameras and sensors (if equipped) to determine the vehicle's proximity to objects, people, animals, and other vehicles. Summon is unlikely to operate as intended in the following types of situations:
- The driving path is sloped. Summon is designed to operate on flat roads only (up to 10% grade).
 - A raised concrete edge is detected. Summon does not move Model X over an edge that is higher than approximately 1 in (2.5 cm).
 - One or more of the sensors (if equipped) or cameras is damaged, dirty, or obstructed (such as by mud, ice, or snow, or by a vehicle bra, excessive paint, or adhesive products such as wraps, stickers, rubber coating, etc.).
 - Weather conditions (heavy rain, snow, fog, or extremely hot or cold temperatures) are interfering with sensor operation.
 - The sensors (if equipped) are affected by other electrical equipment or devices that generate ultrasonic waves.
 - Model X is in Trailer Mode or an accessory is attached.

 **WARNING:** The list above does not represent an exhaustive list of situations that may interfere with proper operation of Summon. It is the driver's responsibility to remain in control of Model X at all times. Pay close attention whenever Summon is actively moving Model X and stay prepared to take immediate action. Failure to do so can result in serious property damage, injury or death.

 **WARNING:** Model X cannot detect obstacles that are located lower than the bumper, are very narrow, or are hanging from a ceiling (for example, bicycles). In addition, many unforeseen circumstances can impair Summon's ability to move in or out of a parking space and, as a result, Summon may not move Model X appropriately. Therefore, you must continually monitor the vehicle's movement and its surroundings and remain prepared to stop Model X at any time.

Smart Summon

 **CAUTION:** Smart Summon is a BETA feature. You must continually monitor the vehicle and its surroundings and stay prepared to take immediate action at any time. It is the driver's responsibility to use Smart Summon safely, responsibly, and as intended.

 **CAUTION:** Smart Summon is designed and intended for use only on parking lots and driveways located on private property where the surrounding area is familiar and predictable. Do not use Smart Summon on public roads.

NOTE: Smart Summon is disabled if Model X is in Valet mode (see [Valet Mode on page 98](#)).

-  **CAUTION:**
- Smart Summon is unlikely to operate as intended in the following types of situations:
- GPS data is unavailable due to poor cellular coverage.
 - The driving path is sloped. Smart Summon is designed to operate on flat roads only (up to 10% grade).
 - A raised concrete edge is detected. Depending on the height of the concrete edge, Smart Summon may not move Model X over it.
 - One or more of the sensors (if equipped) or cameras is damaged, dirty, or obstructed (such as by mud, ice, or snow, or by a vehicle bra, excessive paint, or adhesive products such as wraps, stickers, rubber coating, etc.).
 - Weather conditions (heavy rain, snow, fog, or extremely hot or cold temperatures) are interfering with sensor (if equipped) or camera operation.
 - The sensors (if equipped) are affected by other electrical equipment or devices that generate ultrasonic waves.
 - Model X is in Trailer Mode or an accessory is attached

 **WARNING:** The list above does not represent an exhaustive list of situations that may interfere with proper operation of Smart Summon. It is the driver's responsibility to remain in control of Model X at all times. Pay close attention whenever Smart Summon is actively moving Model X and stay prepared to take immediate action. Failure to do so can result in serious property damage, injury or death.

 **WARNING:** Smart Summon must only be used on paved surfaces.

 **WARNING:** Smart Summon may not stop for all objects (especially very low objects such as some curbs, or very high objects such as a shelf) and may not react to all traffic. Smart Summon does not recognize the direction of traffic, does not navigate around empty parking spaces, and may not anticipate crossing traffic.

 **WARNING:** When using Smart Summon, you must maintain a clear line of sight between you and Model X and stay prepared to stop the vehicle at any time by releasing the button on the mobile app.

 **WARNING:** When you release the button to stop Model X, a slight delay occurs before the vehicle stops. Therefore, it is critical that you pay close attention to the vehicle's driving path at all times and proactively anticipate obstacles that the vehicle may be unable to detect.



Limitations and Warnings

⚠ WARNING: Use extreme caution when using Smart Summon in environments where movement of obstacles can be unpredictable. For example, where people, children or animals are present.

⚠ WARNING: Smart Summon may not stop for all objects (especially very low objects such as some curbs, or very high objects such as a shelf) and may not react to all oncoming or side traffic. Pay attention and be ready to stop Model X at all times by releasing the button on the mobile app.

Model X monitors the markers on the lane you are driving in as well as the surrounding areas for the presence of vehicles or other objects.



WARNING: Ensure all cameras are clean and free of obstructions before each drive and before using Autopilot features (see [Cleaning a Camera on page 191](#)). Dirty cameras and sensors (if equipped), as well as environmental conditions such as rain and faded lane markings, can affect Autopilot performance. If a camera is obstructed or blinded, Model X displays a message on the instrument cluster and Autopilot features may not be available.

WARNING: Lane Assist features are for guidance purposes only and are not intended to replace your own direct visual checks. Before changing lanes, always use side mirrors and perform the appropriate shoulder checks to visually determine if it is safe and appropriate to change lanes.

WARNING: Never depend on Lane Assist to inform you if you unintentionally drive outside of the driving lane, or to inform you that there is a vehicle beside you or in your blind spot. Several external factors can reduce the performance of Lane Assist (see [Limitations and Inaccuracies on page 136](#)). It is the driver's responsibility to stay alert and pay attention to the driving lane and other road users. Failure to do so can result in serious injury or death.

Steering Interventions

Lane Assist provides steering interventions if Model X drifts into (or close to) an adjacent lane in which an object, such as a vehicle, is detected. In these situations, Model X automatically steers to a safer position in the driving lane. This steering is applied only when Model X is traveling between 48 and 140 km/h on major roads with clearly visible lane markings. When a steering intervention is applied, the instrument panel briefly displays a warning message.

Lane Departure Avoidance

Lane Departure Avoidance is designed to warn you if Model X is drifting out of, or nears the edge of, your driving lane.

Lane Departure Avoidance operates when driving between 64 and 145 km/h on roads with clearly visible lane markings. You can choose if and how you want Lane Departure Warning to operate by touching **Controls > Autopilot > Lane Departure Avoidance** and selecting between these options:

- **Off:** You are not warned of lane departures or potential collisions with a vehicle in an adjacent lane.
- **Warning:** If a front wheel passes over a lane marking, the steering wheel vibrates.
- **Assist:** Corrective steering is applied to keep Model X in a safe position if Model X drifts into an adjacent lane or near the edge of the road.

When Lane Departure Avoidance is enabled and Traffic-Aware Cruise Control is active, if Model X drifts out of the driving lane when the associated turn signal is off, Lane Assist also checks to see whether your hands are on the steering wheel. If hands are not detected, the instrument panel displays a series of alerts. If hands are repeatedly not detected Model X gradually slows down to 25 km/h below the detected speed limit, or below the set cruising speed, and the hazard lights start flashing.

NOTE: Lane Departure Avoidance does not warn you of lane departures, or provide steering interventions, if the associated turn signal is on, which indicates an intentional lane change.

WARNING: Lane Departure Avoidance is intended to help keep you safe, but it does not work in every situation and does not replace the need to remain attentive and in control.

WARNING: Keep your hands on the steering wheel and drive attentively at all times.

WARNING: Steering interventions are minimal and are not designed to move Model X out of its driving lane. Do not rely on steering interventions to avoid side collisions.

Emergency Lane Departure Avoidance

Emergency Lane Departure Avoidance automatically applies steering to avoid a potential collision in situations where:

- Model X is departing a lane and may collide with a vehicle traveling in the same direction in the adjacent lane (regardless of the status of the turn signal).
- Model X is departing a lane into an oncoming lane, the turn signal is off, and an oncoming vehicle is detected.
- Model X is departing the road and the turn signal is off (for example, very close to the edge of the road and a collision may occur).



Lane Assist

To turn this feature on or off, touch **Controls > Autopilot > Emergency Lane Departure Avoidance**.

When Emergency Lane Departure Avoidance applies steering, a chime sounds and the instrument panel displays a warning and highlights the lane marking in red.

Emergency Lane Departure Avoidance operates when Model X is traveling between 48 and 145 km/h on a road with clearly visible lane markings, curbs, etc.

WARNING: Emergency Lane Departure Avoidance is not a substitute for attentive driving and sound judgment. Keep your eyes on the road when driving and never depend on Emergency Lane Departure Avoidance to prevent a collision. Several factors can reduce or impair performance. Depending on Emergency Lane Departure Avoidance to prevent a potential collision can result in serious injury or death.

Blind Spot Assist

Blind Spot Collision Warning Chime

If you want a chime to sound when a vehicle is in your blind spot and a possible collision is detected, touch **Controls > Safety > Blind Spot Collision Warning Chime**.

WARNING: Blind Spot Camera does not eliminate the need to drive attentively and manually perform shoulder checks when changing lanes.

WARNING: Blind Spot Collision Warning Chime cannot detect every collision. It is the driver's responsibility to remain alert and perform the appropriate shoulder checks when changing lanes.

Limitations and Inaccuracies

Lane Assist features cannot always detect lane markings and you may experience unnecessary or invalid warnings when:

- Visibility is poor and lane markings are not clearly visible (due to heavy rain, snow, fog, etc.).
- Bright light (such as from oncoming headlights or direct sunlight) is interfering with the view of the camera(s).
- A vehicle in front of Model X is blocking the view of the camera(s).
- The windshield is obstructing the view of the camera(s) (fogged over, dirty, covered by a sticker, etc.).
- Lane markings are excessively worn, have visible previous markings, have been adjusted due to road construction, or are changing quickly (for example, lanes branching off, crossing over, or merging).
- The road is narrow or winding.
- Objects or landscape features are casting strong shadows on lane markers.

Lane Assist may not provide warnings, or may apply inappropriate warnings, when:

- One or more of the sensors (if equipped), or cameras is damaged, dirty, or obstructed (by mud, ice, or snow, or by a vehicle bra, excessive paint, or adhesive products such as wraps, stickers, rubber coatings, etc.).
- Weather conditions (heavy rain, snow, fog, or extremely hot or cold temperatures) are interfering with sensor operation.
- The sensors (if equipped) are affected by other electrical equipment or devices that generate ultrasonic waves.
- An object that is mounted to Model X is interfering with and/or obstructing a sensor (such as a bike rack or a bumper sticker).

In addition, Lane Assist may not steer Model X away from an adjacent vehicle, or may apply unnecessary or inappropriate steering, in these situations:

- You are driving Model X on sharp corners or on a curve at a relatively high speed.
- Bright light (such as from oncoming headlights or direct sunlight) is interfering with the view of the camera(s).
- You are drifting into another lane but an object (such as a vehicle) is not present.
- A vehicle in another lane cuts in front of you or drifts into your driving lane.
- Model X is not traveling within the speeds at which the Lane Assist feature is designed to operate.
- One or more of the sensors (if equipped) is damaged, dirty, or obstructed (such as by mud, ice, or snow, or by a vehicle bra, excessive paint, or adhesive products such as wraps, stickers, rubber coating, etc.).
- Weather conditions (heavy rain, snow, fog, or extremely hot or cold temperatures) are interfering with sensor operation.
- The sensors (if equipped) are affected by other electrical equipment or devices that generate ultrasonic waves.
- An object mounted to Model X (such as a bike rack or a bumper sticker) is interfering with or obstructing a sensor.
- Visibility is poor and lane markings are not clearly visible (due to heavy rain, snow, fog, etc.).
- Lane markings are excessively worn, have visible previous markings, have been adjusted due to road construction or are changing quickly (for example, lanes branching off, crossing over, or merging).

CAUTION: Driver assistance features are automatically disabled when Track Mode is On. It is the driver's responsibility to drive safely and be in control of the vehicle at all times, including on track. Driver Assistance features automatically re-enable when Track Mode is turned Off.

 **WARNING:** The lists above do not represent every possible situation that may interfere with Lane Assist features. There are many reasons why Lane Assist may not operate as intended. To avoid a collision, stay alert and always pay attention to the road so you can anticipate the need to take corrective action as early as possible.



Collision Avoidance Assist

The following collision avoidance features are designed to increase the safety of you and your passengers:

- **Forward Collision Warning** - provides visual and audible warnings in situations when Model X detects that there is a high risk of a frontal collision (see [Forward Collision Warning on page 138](#)).
- **Automatic Emergency Braking** - automatically applies braking to reduce the impact of a collision (see [Automatic Emergency Braking on page 139](#)).
- **Obstacle-Aware Acceleration** - reduces acceleration if Model X detects an object in its immediate driving path (see [Obstacle-Aware Acceleration on page 139](#)).

CAUTION: Ensure all cameras are clean and free of obstructions before each drive and before using Autopilot features (see [Cleaning a Camera on page 191](#)). Dirty cameras and sensors (if equipped), as well as environmental conditions such as rain and faded lane markings, can affect Autopilot performance. If a camera is obstructed or blinded, Model X displays a message on the instrument cluster and Autopilot features may not be available.

WARNING: Forward Collision Warning is for guidance purposes only and is not a substitute for attentive driving and sound judgment. Keep your eyes on the road when driving and never depend on Forward Collision Warning to warn you of a potential collision. Several factors can reduce or impair performance, causing either unnecessary, invalid, inaccurate, or missed warnings. Depending on Forward Collision Warning to warn you of a potential collision can result in serious injury or death.

WARNING: Automatic Emergency Braking is not designed to prevent all collisions. In certain situations, it can minimize the impact of a collision by attempting to reduce your driving speed. Depending on Automatic Emergency Braking to avoid a collision can result in serious injury or death.

WARNING: Obstacle-Aware Acceleration is not designed to prevent a collision. In certain situations, it can minimize the impact of a collision. Depending on Obstacle-Aware Acceleration to avoid a collision can result in serious injury or death.

Forward Collision Warning

Model X monitors the area in front of it for the presence of an object such as a vehicle, motorcycle, bicycle, or pedestrian. If a collision is considered likely unless you take immediate corrective action, Forward Collision Warning is designed to sound a chime and highlight the vehicle in front of you in red on the instrument panel. If this happens, **TAKE IMMEDIATE CORRECTIVE ACTION!**



Visual and audible warnings cancel automatically when the risk of a collision has been reduced (for example, you have decelerated or stopped Model X, or the object in front of your vehicle has moved out of your driving path).

If immediate action is not taken when Model X issues a Forward Collision Warning, Automatic Emergency Braking (if enabled) may automatically apply the brakes if a collision is considered imminent (see [Automatic Emergency Braking on page 139](#)).

By default, Forward Collision Warning is turned on. To turn off or adjust sensitivity, touch **Controls > Autopilot > Forward Collision Warning**. Instead of the default warning level of **Medium**, you can turn the warning **Off**, or you can choose to be warned **Late** or **Early**.

NOTE: Forward Collision Warning automatically resets to **Medium** at the beginning of each drive if you manually turn this feature **Off**.

WARNING: The camera(s) and sensors (if equipped) associated with Forward Collision Warning are designed to monitor an approximate area of up to 160 meters in your driving path. The area being monitored by Forward Collision Warning can be adversely affected by road and weather conditions. Use appropriate caution when driving.

WARNING: Forward Collision Warning is designed only to provide visual and audible alerts. It does not attempt to apply the brakes or decelerate Model X. When seeing and/or hearing a warning, it is the driver's responsibility to take immediate corrective action.

WARNING: Forward Collision Warning may provide a warning in situations where the likelihood of collision may not exist. Stay alert and always pay attention to the area in front of Model X so you can anticipate whether any action is required.

Forward Collision Warning operates only when driving between approximately 5 km/h and 200 km/h.

WARNING: Forward Collision Warning does not provide a warning when the driver is already applying the brake.



Automatic Emergency Braking

Model X is designed to determine the distance from detected objects. When a collision is considered unavoidable, Automatic Emergency Braking is designed to apply the brakes to reduce the vehicle's speed and therefore, the severity of the impact. The amount of speed that is reduced depends on many factors, including driving speed and environment.

When Automatic Emergency Braking applies the brakes, the instrument panel displays a visual warning and sounds a chime. You may also notice abrupt downward movement of the brake pedal. The brake lights turn on to alert other road users that you are slowing down.



Emergency braking in progress



Automatic Emergency Braking operates only when driving between approximately 5 km/h and 200 km/h.

Automatic Emergency Braking does not apply the brakes, or stops applying the brakes, when:

- You turn the steering wheel sharply.
- You press and release the brake pedal while Automatic Emergency Braking is applying the brakes.
- You accelerate hard while Automatic Emergency Braking is applying the brakes.
- The vehicle, motorcycle, bicycle, or pedestrian is no longer detected in the front or rear of the vehicle.

Automatic Emergency Braking is always enabled when you start Model X. To disable it for your current drive, touch **Controls > Autopilot > Automatic Emergency Braking**.

NOTE: Automatic Emergency Braking is designed to reduce the impact of frontal and reverse collisions with limited functionality while in Reverse.

-  **WARNING:** It is strongly recommended that you do not disable Automatic Emergency Braking. If you disable it, Model X does not automatically apply the brakes in situations where a collision is considered likely.
-  **WARNING:** Automatic Emergency Braking is designed to reduce the severity of an impact. It is not designed to avoid a collision.
-  **WARNING:** Several factors can affect the performance of Automatic Emergency Braking, causing either no braking or inappropriate or untimely braking, such as when a vehicle is partially in the path of travel or there is road debris. It is the driver's responsibility to drive safely and remain in control of the vehicle at all times. Never depend on Automatic Emergency Braking to avoid or reduce the impact of a collision.

 **WARNING:** Automatic Emergency Braking is not a substitute for maintaining a safe traveling distance between you and the vehicle in front of you.

 **WARNING:** The brake pedal moves downward abruptly during automatic braking events. Always ensure that the brake pedal can move freely. Do not place material under or on top of the driver's floor mat (including an additional mat) and always ensure that the driver's floor mat is properly secured. Failure to do so can impede the ability of the brake pedal to move freely.

Rear Cross Traffic Alert

When Model X is in Reverse and the touchscreen is displaying the rear view camera feed, a vertical red bar appears when Model X detects that an object (such as another vehicle or a pedestrian) is about to cross behind Model X.

For example, if you are backing out of a parking space and another vehicle is approaching from your left, a red bar appears on the left side of the camera view. If there are objects approaching from both sides of Model X, red bars appear on both sides of the camera view.

When Model X is reversing and cross traffic is detected, Automatic Emergency Braking or Obstacle-Aware Acceleration may apply the brakes to attempt to avoid a collision. Do not rely on Automatic Emergency Braking or Obstacle-Aware Acceleration to prevent a collision. For more information, see [Automatic Emergency Braking on page 139](#) and [Obstacle-Aware Acceleration on page 139](#).

 **WARNING:** Never depend on Rear Cross Traffic Alert to inform you if the area surrounding your vehicle is free of objects and/or people. The cameras may not detect objects or barriers that can potentially cause damage or injury, especially objects very low to the ground. In addition, several external factors can reduce the performance of the cameras, including a dirty or obstructed lens. Always inspect the area with your own eyes. When reversing, perform shoulder checks and use all mirrors. Use the cameras for guidance purposes only. Rear Cross Traffic Alert is not intended to replace your own direct visual checks and is not a substitute for careful driving.

Obstacle-Aware Acceleration

Obstacle-Aware Acceleration is designed to reduce the impact of a collision by reducing motor torque and in some cases applying the brakes, if Model X detects an object in its driving path. The instrument panel displays a visual warning and sounds a chime when the brakes are automatically applied. For example, Model X, while parked in front of a closed garage door with Drive engaged, detects that you have pressed hard on the accelerator pedal. Although Model X still accelerates and hits the garage door, the reduced torque may result in less damage.

Obstacle-Aware Acceleration is designed to operate only when all of these conditions are simultaneously met:





Collision Avoidance Assist

- Drive or Reverse is engaged.
- Model X is stopped or traveling less than 16 km/h.
- Model X detects an object in its immediate driving path.

To disable Obstacle-Aware Acceleration, touch **Controls** > **Autopilot** > **Obstacle-Aware Acceleration**.

 **WARNING:** Obstacle-Aware Acceleration is designed to reduce the severity of an impact. It is not designed to avoid a collision.

 **WARNING:** Obstacle-Aware Acceleration may not limit torque in all situations, such as performing a sharp turn into a parking space. Several factors, including environmental conditions, distance from an obstacle, and a driver's actions, can limit, delay, or inhibit Obstacle-Aware Acceleration.

 **WARNING:** Do not rely on Obstacle-Aware Acceleration to control acceleration or to avoid, or limit, the severity of a collision, and do not attempt to test Obstacle-Aware Acceleration. Doing so can result in serious property damage, injury, or death.

 **WARNING:** Several factors can affect the performance of Obstacle-Aware Acceleration, causing an inappropriate or untimely reduction in motor torque and/or undesired braking. It is the driver's responsibility to drive safely and remain in control of Model X at all times.



CAUTION: Driver assistance features are automatically disabled when Track Mode is On. It is the driver's responsibility to drive safely and be in control of the vehicle at all times, including on track. Driver Assistance features automatically re-enable when Track Mode is turned Off.



WARNING: The limitations previously described do not represent an exhaustive list of situations that may interfere with proper operation of Collision Avoidance Assist features. These features may fail to provide their intended function for many other reasons. It is the driver's responsibility to avoid collisions by staying alert, paying attention, and taking corrective action as early as possible.

Limitations and Inaccuracies

Collision Avoidance features cannot always detect all objects, vehicles, bikes, or pedestrians, and you may experience unnecessary, inaccurate, invalid, or missed warnings for many reasons, particularly if:

- The road has sharp curves.
- Visibility is poor (due to heavy rain, snow, fog, etc.).
- Bright light (such as from oncoming headlights or direct sunlight) is interfering with the view of the camera(s).
- A camera or sensor is obstructed (dirty, covered, fogged over, covered by a sticker, etc.).
- One or more of the sensors (if equipped) is damaged, dirty, or obstructed (such as by mud, ice, or snow, or by a vehicle bra, excessive paint, or adhesive products such as wraps, stickers, rubber coating, etc.).
- Weather conditions (heavy rain, snow, fog, or extremely hot or cold temperatures) are interfering with sensor operation.
- The sensors (if equipped) are affected by other electrical equipment or devices that generate ultrasonic waves.



CAUTION: If a fault occurs with a Collision Avoidance Assist feature, Model X displays an alert. Contact Tesla Service.

How Speed Assist Works

Model X displays a speed limit on the instrument panel and you can choose if and how you are warned when you exceed the speed limit. In addition, a blue outline may appear around the speed limit icon to notify that you are above the speed limit.

Instead of using the detected speed limit, you can base warnings on an arbitrary speed limit that you enter manually.

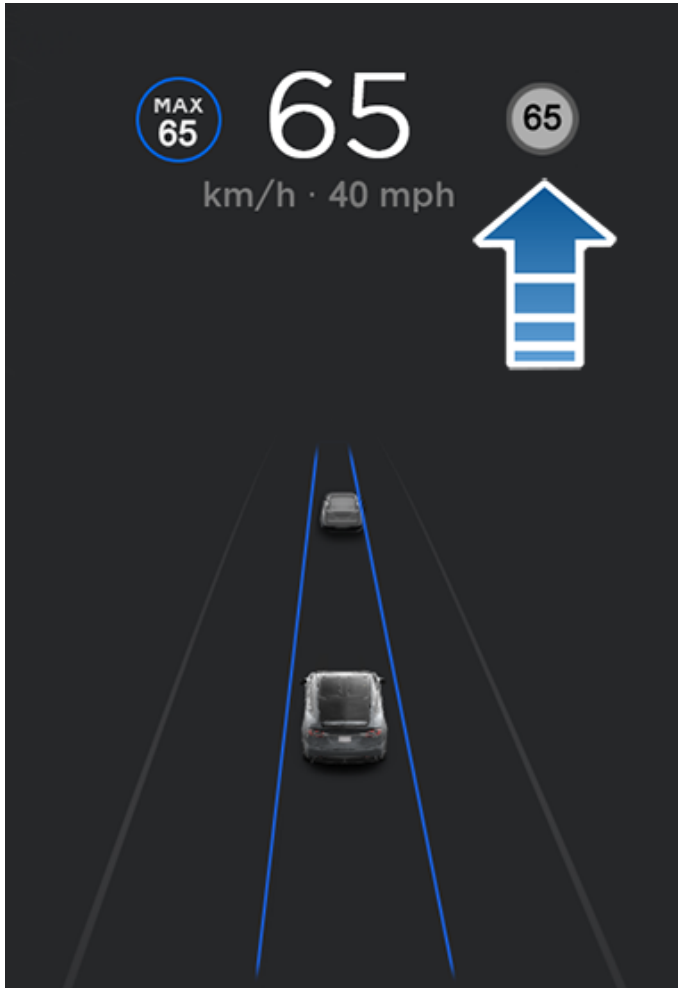

In situations where Model X is unable to determine a speed limit, or if Speed Assist is uncertain that an acquired speed limit is accurate, the instrument panel may not display a speed limit sign and warnings do not take effect.

NOTE: Speed limit warnings go away after ten seconds, or when Model X slows down below the specified limit.

 **WARNING:** Do not rely on Speed Assist to determine the appropriate speed limit or driving speed. Always drive at a safe speed based on traffic and road conditions.

Controlling Speed Assist

To adjust the Speed Limit Warning setting, touch **Controls** > **Autopilot** > **Speed Limit Warning**, then choose one of these options:

- **Off** - Speed limit warnings do not display and chimes are not sounded.
- **Display** - Speed limit signs display on the instrument panel and the sign increases in size when you exceed the determined limit.
- **Chime** - In addition to the visual display, a chime is sounded when you exceed the determined speed limit.

You can also specify how the speed limit is determined:

- **Relative** - You can set a speed limit offset (+ or -) if you want to be alerted only when you exceed the offset speed limit by a specified amount. For example, you can increase the offset to +10 km/h if you only want to be warned when you exceed the speed limit by 10 km/h.

NOTE: The offset from speed limit also affects the number shown in the gray speed icon on the instrument panel.

- **Absolute** - Manually specify any speed limit between 30 and 240 km/h.

NOTE: Speed Assist is not always accurate. In some situations, the location of a road can be miscalculated and Speed Assist can display a speed for a directly adjacent road that may have a different speed limit. For example, Speed Assist can assume Model X is on a controlled-access highway when it is actually on a nearby surface street, and vice versa.

NOTE: Your chosen setting is retained until you manually change it.

Limitations and Inaccuracies

Speed Assist may not be fully functional or may provide inaccurate information in these situations:

- Visibility is poor and speed limit signs are not clearly visible (due to heavy rain, snow, fog, etc.).
- Bright light (such as from oncoming headlights or direct sunlight) is interfering with the view of the camera(s).
- Model X is being driven very close to a vehicle in front of it which is blocking the view of the camera(s).
- The windshield is obstructing the view of the camera(s) (fogged over, dirty, covered by a sticker, etc.).
- Speed limit signs are concealed by objects.
- The speed limits stored in the map database are incorrect or outdated.
- Model X is being driven in an area where GPS or map data is not available or where speed limit signs can not be detected.



Speed Assist

- Traffic signs that do not conform to standard recognizable formats, such as digital or temporary speed signs.
- A road or a speed limit has recently changed.

 **WARNING:** The list above does not represent an exhaustive list of situations that may interfere with proper operation of Speed Assist. Speed Assist may fail to provide warnings for many other reasons.



About the Security System

If Model X does not detect a key nearby and a locked door or trunk is opened, an alarm sounds. The headlights and turn signals also flash. To deactivate the alarm, press any button on the key fob.

To manually enable or disable the alarm system, touch **Controls > Safety > Security Alarm**. When enabled, Model X activates its alarm one minute after you exit, the doors lock, and a recognized key is no longer detected.

A battery-backed siren (if equipped) sounds in situations where a locked door or trunk is opened and Model X does not detect a key nearby. If you also want this siren to sound in situations where the vehicle detects motion inside the cabin, enable **Tilt/Intrusion** (see [Tilt/Intrusion \(if equipped\) on page 143](#)).

NOTE: If Model X is in Sentry Mode (see [How to Use Sentry Mode \(With a USB Flash Drive\) on page 146](#)), the **Security Alarm** setting is not available.

Tilt/Intrusion (if equipped)

Depending on configuration, market region, and date of manufacture, your vehicle may not be equipped with this feature.

The **Security Alarm** must be on to enable **Tilt/Intrusion**.

Tilt/Intrusion sounds the alarm in your vehicle if Model X detects motion inside the cabin, or is moved or tilted (for example, with a tow truck or jack). To enable, touch **Controls > Safety > Tilt/Intrusion**.

The intrusion sensor automatically disables in situations where the climate control system is operating when you leave your vehicle. To override, you can manually turn the Tilt/Intrusion Sensor on again after choosing Keep Climate On, Dog, or Camp Mode.

The tilt/intrusion sensor automatically re-enables at the start of every drive cycle.

NOTE: The **Tilt/Intrusion** alarm must be turned off to use **Cabin Overheat Protection** (see [Cabin Overheat Protection on page 153](#)).

NOTE: If you plan to leave something that moves inside your locked vehicle, remember to turn off **Tilt/Intrusion**. If this setting is on, any motion detected inside Model X activates the intrusion alarm.

NOTE: If Model X is in Sentry Mode (see [How to Use Sentry Mode \(With a USB Flash Drive\) on page 146](#)), the **Tilt/Intrusion** setting is not available.

Enhanced Anti-Theft Upgrade (if equipped)

If your vehicle is equipped with the Enhanced Anti-Theft upgrade, the horn sounds in situations where a locked door or trunk is opened and Model X does not detect a key nearby. If **Tilt/Intrusion** is on, the horn also sounds if Model X detects motion inside the cabin or if the vehicle is moved or tilted (for example, with a tow truck or jack). To turn the Tilt/Intrusion detection system on or off, touch **Controls > Safety > Tilt/Intrusion**.

PIN to Drive

For an added layer of security, prevent Model X from being driven until a 4-digit PIN (Personal Identification Number) is entered. To enable this setting, touch **Controls > Safety > PIN to Drive** and follow the on-screen prompts to create a driving PIN.

When enabled, in addition to entering the 4-digit driving PIN to drive, you must also use it to enter Valet mode for the first time and create the 4-digit valet PIN to enter and exit Valet mode. In Valet mode, Model X can be driven without the need for the valet to enter a driving PIN. The **PIN to Drive** setting is disabled whenever Valet mode is active.

If you forget your driving PIN, touch the link to enter your Tesla login credentials on the PIN to Drive popup, then follow the instructions on the touchscreen.

NOTE: In the unlikely event that your touchscreen is unresponsive, you may be unable to enter the PIN. In this case, first try to restart the touchscreen (see [Restarting the Touchscreen or Instrument Panel on page 8](#)). If the touchscreen is still unresponsive, you can still bypass PIN to Drive by turning on Keyless Driving in the Tesla mobile app.

Glovebox PIN

Protect the contents in your glovebox with a 4-digit PIN (not related to PIN to Drive). To enable, touch **Controls > Safety > Glovebox PIN** and follow the directions on the touchscreen. When enabled, you are prompted to enter the PIN to open the glovebox. Select the toggle to disable and then enter the PIN to remove this added security protection.

If you forget your glovebox PIN, reset it by entering your Tesla login credentials, then follow the directions on the touchscreen.

NOTE: Using a **Glovebox PIN** allows the glovebox to be opened even when Model X is in Valet mode.

Speed Limit Mode

Speed Limit Mode allows you to limit acceleration and maximum driving speed to a chosen value between 80 and 193 km/h. The first time you use this feature, you must create a 4-digit PIN that you must use to enable and disable Speed Limit Mode. When enabled and the driving speed approaches



Safety & Security Settings

within approximately 5 km/h of the maximum speed, a chime sounds, the instrument cluster displays a message, and Model X sends a notification to the mobile app. You can also touch **Security > Speed Limit Mode** to enable from the Tesla mobile app. To enable Speed Limit Mode:

1. Ensure Model X is in Park.
2. Touch **Controls > Safety > Speed Limit Mode** on the touchscreen.
3. Select the maximum driving speed.
4. Drag the slider to the **On** position.
5. Enter the 4-digit PIN that you want to use to enable and disable Speed Limit Mode.

NOTE: If you forget the PIN, you can disable Speed Limit Mode by entering login credentials for your Tesla account.

NOTE: While Speed Limit Mode is enabled, the acceleration setting automatically sets to **Chill**.

 **WARNING:** Driving downhill can increase driving speed and cause Model X to exceed your chosen maximum speed.

 **WARNING:** Speed Limit Mode is not a replacement for good judgment, driver training, and the need to closely monitor speed limits and driving conditions. Accidents occur at any speed and it is your responsibility to drive safely.

Clear Browser Data

You can clear your vehicle's browser data (like you would on a computer or smartphone) by navigating to **Controls > Service > Clear Browser Data**. This is useful for many situations, such as erasing settings or searches from another driver.

Check the boxes on the touchscreen popup to exclude bookmarks and/or history for your convenience.

NOTE: Depending on market region, vehicle configuration, options purchased, and software version, your vehicle may not be equipped with Dashcam or the features may not operate exactly as described. **It is your sole responsibility to consult and comply with all local regulations and property restrictions regarding the use of cameras.**

Dashcam records video footage of your vehicle's surroundings while driving. Use Dashcam to record driving incidents or other notable events, like you would for an external dashcam on other vehicles.

The Dashcam icon is located in the app launcher. You can add the Dashcam app to the bottom bar for easy access (see [Customizing My Apps on page 7](#)). When Model X is in Park, touching the Dashcam icon displays the Viewer (see [Viewing Video Recordings on page 148](#)).



To protect your privacy, video recordings are saved locally to a formatted USB flash drive's onboard memory. Recordings are not sent to Tesla. Model X does not record videos when Dashcam is **Off**.

How to Use Dashcam

1. Format a USB flash drive. Dashcam requires a properly formatted USB drive inserted in your vehicle's USB port to store and retrieve footage. Vehicles manufactured beginning approximately 2020 are equipped with a pre-formatted USB flash drive in the glove box. There are two ways to format the flash drive if needed:
 - Format the flash drive with Model X. Insert the flash drive into the USB port and navigate to **Controls > Safety > Format USB Drive**.
 - Format the flash drive on a computer. See [USB Drive Requirements for Recording Videos on page 148](#) for more information.
2. Insert the USB flash drive into your vehicle's USB port, preferably the one in the glovebox (if equipped).
3. Enable Dashcam by touching **Controls > Safety > Dashcam**. Dashcam allows you to choose how and when footage is saved. You can choose between:
 - **Auto:** Dashcam automatically saves a recording to the USB drive when Model X detects a safety-critical event, such as a collision or airbag deployment. When **Auto** is selected, detection can vary and is subject to your vehicle's power, sleep, and Autopilot state.

NOTE: Several factors determine whether Dashcam automatically saves a recording of a safety-critical event (for example, amount of force, whether or not airbags deploy, etc.). Do not rely on Dashcam to automatically record all safety-critical events.

- **Manual:** You must manually touch the Dashcam icon to save a recording of the most recent ten minutes of footage.
- **On Honk:** When you press the horn, Dashcam saves a recording of the most recent ten minutes of footage. You can enable this along with **Auto** or **Manual** simultaneously.

4. Once enabled, the Dashcam icon indicates when footage is saved.



The icon changes to show the status of Dashcam:



RECORDING: Dashcam is recording. To save video footage, touch the icon. To pause recording, press and hold the icon.



AVAILABLE: Dashcam is available but not actively recording. Touch the dashcam icon to start recording footage.



PAUSED: Dashcam is paused. To resume recording, touch the icon. To avoid losing video footage, pause Dashcam before removing the flash drive.



BUSY: Dashcam is in the process of loading, saving, or overwriting footage. While dashcam is busy, footage is not being captured and recorded.



SAVED: Footage is saved.

5. When your desired footage is saved, view the clips on the touchscreen or a computer:
 - Touchscreen: Ensure Model X is in Park and touch the Dashcam icon in the app launcher. Videos are organized by timestamp. See [Viewing Video Recordings on page 148](#) for more information.
 - Computer: Insert the USB flash drive into a computer and navigate to the TeslaCam folder. Videos are organized by timestamp. See [Viewing Video Recordings on page 148](#) for more information.
6. To turn Dashcam off, navigate to **Controls > Safety > Dashcam > Off**. If set to **Auto**, **Manual**, or **On Honk**, Dashcam automatically enables (but may not be actively saving footage, depending on your preferences) every time you drive.



Sentry Mode

NOTE: Depending on market region, vehicle configuration, options purchased, and software version, your vehicle may not be equipped with Sentry Mode or the features may not operate exactly as described. **It is your sole responsibility to consult and comply with all local regulations and property restrictions regarding the use of cameras.**

When enabled, your vehicle's cameras and sensors (if equipped) remain powered on and ready to record suspicious activity around your vehicle when Model X is locked and in Park. Think of Sentry Mode as an intelligent vehicle security system that alerts you when it detects possible threats nearby.

If a threat is detected or the vehicle sensors determine there is a lot of jerky movement like when getting towed or shaken, Sentry Mode:

- Pulsed the headlights.
- Sounds the alarm.
- Displays a message on the touchscreen that indicates cameras may be recording to inform individuals outside of the vehicles.
- Alerts you of the alarm on the mobile app.
- Saves footage of the event to a USB drive (if installed).

Sentry Mode is disabled by default. You can use voice commands or the Tesla mobile app to easily enable or disable Sentry Mode. To enable Sentry Mode using voice commands, say "Keep Tesla safe," "Keep my car safe," "Sentry on," or "Enable Sentry" (see [Voice Commands on page 17](#)).

Sentry Mode requires your Battery to be at least 20% charged. If the Battery falls below 20%, Sentry Mode turns off and the mobile app sends you a notification. Power consumption may increase when Sentry Mode is active.

NOTE: When Sentry Mode is enabled, the Security Alarm settings (**Controls > Safety > Security Alarm**) are not available.

CAUTION: Do not rely on Sentry Mode to protect Model X from all possible security threats. Sentry Mode uses many factors to determine whether to activate the security alarm. All impacts may not be detected and the alarm may not activate in all situations. While it may help deter some threats, no security system can prevent all attacks.

NOTE: Sentry Mode only sends notifications to the mobile app when the alarm is triggered, when someone attempts to open a door or trunk, or sudden jerky motions are detected by the vehicle. If Sentry Mode doesn't consider an event a clear threat, the vehicle records footage but doesn't trigger the alarm.

How to Use Sentry Mode (With a USB Flash Drive)

1. Sentry Mode requires a properly formatted USB drive inserted in your vehicle's USB port. Vehicles manufactured beginning approximately 2020 are equipped with a pre-formatted USB flash drive in the glove box. There are two ways to format the USB drive:
 - Insert the USB drive into the USB port and navigate to **Controls > Safety > Format USB Drive**. Your vehicle automatically formats the USB drive for you.
 - Format the USB drive on a computer. See [USB Drive Requirements for Recording Videos on page 148](#) for more information.
2. Insert the USB drive into the vehicle's USB port, preferable the one in the glove box (if equipped).
3. With your vehicle in Park, enable Dashcam by navigating to **Controls > Safety > Dashcam** (Dashcam must be enabled for Sentry Mode to work).
4. Touch **Controls > Safety > Sentry Mode > On**. Once enabled, the Sentry Mode icon on the status bar turns red.



NOTE: Rear camera recordings are available only on vehicles manufactured after approximately February 2018.

When enabled, Sentry Mode is idle, ready to sound the alarm and save a recording of the security event if triggered. See [Viewing Video Recordings on page 148](#) for information on viewing footage.

5. To manually enable/disable Sentry Mode until the next drive, touch the Sentry Mode icon. Sentry Mode is Off when the icon is no longer red.



Turn Sentry Mode **Off** in **Controls > Safety > Sentry Mode** to disable for more than one drive cycle.

How to Use Sentry Mode (Without a USB Flash Drive)

When Sentry mode is enabled and a security event is detected but without a USB drive plugged into a USB port, your vehicle alerts you through the mobile app, without any camera recordings.

Sentry Mode Settings

- **Exclude specific locations**

In **Controls > Safety > Sentry Mode**, you can determine if you want Sentry Mode to *not* enable in certain locations (see [Home](#), [Work](#), and [Favorite Destinations](#) on page 160 for more information):

- **Exclude Home:** Sentry Mode does not automatically enable at the location set as Home in your Favorites list.
- **Exclude Work:** Sentry Mode does not automatically enable at the location set as Work in your Favorites list.
- **Exclude Favorites:** Sentry Mode does not automatically enable at any location in your Favorites list.

NOTE: To recognize a location listed as Home, Work, or a Favorite, Model X must be parked within approximately 500 meters of the saved location.

To set up your Home or Work location, touch **Navigate > Set Home/Set Work**. To set up a **Favorite**, touch the star when viewing an address on the map. Manually turning Sentry Mode on or off using the touchscreen or the mobile app overrides your Home, Work, or Favorite exclusion preferences until your next drive.

- **Set Camera-Based Detection**

When **Camera-Based Detection** is enabled, Sentry Mode uses the vehicle's external cameras in addition to vehicle sensors to detect a security event while parked. If disabled, your vehicle only saves clips to the USB drive if a physical threat is detected. To adjust, touch **Controls > Safety > Sentry Mode > Camera-Based Detection**.

See [Viewing Video Recordings](#) on page 148 for more information on viewing Sentry Mode footage.

NOTE: When the internal storage reaches full capacity, new recordings overwrite the older recordings.



USB Drive Requirements for Recording Videos

NOTE: The ability to format and store video footage on USB drives may not be available on your vehicle depending on the date of manufacture and vehicle configuration.

Some features require you to use a USB drive (for example, Dashcam, Sentry Mode) that meet these requirements:

- Minimum storage capacity of 64 GB. Use a USB drive with as much available storage as possible. Video footage can occupy a large amount of space.
- A sustained write speed of at least 4 MB/s. Note that sustained write speed differs from peak write speed.
- USB 2.0 compatible. If using a USB 3.0 drive, it must also support USB 2.0.
- Properly formatted (either automatically or [manually on page 148](#)).

NOTE: In some market regions you can purchase recommended USB drives on <http://www.tesla.com>.

Automatically Formatting a USB Drive

Insert the USB drive into a front USB port that supports the ability to format, save, and view video footage (see [Interior Electronics on page 10](#)). Then, touch **Controls** > **Safety** > **Format USB Drive**. This automatically formats the USB drive as exFAT and creates folders for TeslaCam. The USB drive is now ready to record and save video footage.

Format USB Drive is available only when a USB drive (with one or fewer partitions) is inserted into a front USB port. Choosing **Format USB Drive** erases any existing content on the USB drive. Before using this feature, move any content you want to keep to a different device.

Manually Formatting a USB Drive

If Model X is unable to format the USB drive, format it using a computer:

1. Format the USB drive as exFAT, MS-DOS FAT (for Mac), ext3, or ext4 (NTFS is currently not supported).
2. Create a base-level folder titled **TeslaCam**. You can use one USB drive for Dashcam, Sentry Mode, and audio files, but you must create separate partitions or folders on the exFAT USB drive.
3. Once formatted, insert the USB drive into the glovebox USB port (if equipped), otherwise use a front USB port in the center console. Do not use a rear USB port because they can only charge devices. It may take a few seconds for Model X to recognize the USB drive.
4. Once recognized, ensure icons for Dashcam and Sentry Mode appear at the top of your touchscreen. Model X is now ready to record videos.

NOTE: You may need to first enable Sentry Mode (if equipped) by touching **Controls** > **Safety** > **Sentry Mode**.

Viewing Video Recordings

If footage is saved, you can view the clips on the touchscreen or a computer.

When the USB drive runs out of storage space, video footage can no longer be saved. To prevent the USB drive from getting full, regularly move saved videos to another device and delete them from the USB drive.

When enabled, Dashcam and Sentry Mode records footage in cycles. Footage is continuously overwritten unless you save it. You must save your desired footage to view it, otherwise the footage is erased and overwritten. See [Sentry Mode on page 146](#) and [Dashcam on page 145](#) for information on saving footage. Four videos are recorded for each saved clip, one from each camera (front, rear, left, and right).

NOTE: Rear camera recordings are only available on vehicles manufactured after approximately February 2018.

Viewing on the Touchscreen

You can view recorded footage on the touchscreen when Model X is in Park. Touch the Dashcam icon located in the app launcher. The tabs display a list of all video clips, organized by location and timestamp. Pause, rewind, fast forward, and delete clips as needed. Swipe to the right or press and hold to quickly delete certain clips.

Navigate to **Controls** > **Safety** > **Delete Dashcam Clips** to delete all Dashcam and Sentry Mode footage.

NOTE: Dashcam recording pauses when you launch the Viewer.

Viewing on a Computer

Insert the USB drive into a computer and navigate to the TeslaCam folder.

The TeslaCam folder contains these sub-folders:

- **RecentClips:** Contains up to 60 minutes of recorded content.
- **SavedClips:** Contains all recordings that are saved and renamed from the RecentClips folder.
- **SentryClips:** Contains recordings from all Sentry Mode security events. If storage space on the USB drive becomes limited, the oldest Sentry Clips are deleted to provide space for new ones. Once deleted, you cannot retrieve them.



Overview of Climate Controls

Climate controls are available at the bottom of the touchscreen. By default, climate control is set to **Auto**, which maintains optimum comfort in all but the most severe weather conditions. When you adjust the cabin temperature while in the **Auto** setting, the system automatically adjusts the heating, air conditioning, air distribution, and fan speed to maintain the cabin at your selected temperature.

Touch the displayed temperature at the bottom of the touchscreen to access the main climate controls screen, where you can adjust your climate preferences. You can return to Auto at any time by touching **Auto**. Touch the power button on the main climate controls screen to toggle on or off. For quick access to common controls, touch **<** or **>** to display the climate popup.

NOTE: The climate control system is powered by the high voltage Battery. Therefore, prolonged use decreases driving range.



WARNING: To avoid burns resulting from prolonged use, individuals who have peripheral neuropathy, or whose capacity to feel pain is limited because of diabetes, age, neurological injury, or some other condition, should exercise caution when using the climate control system and seat heaters.

Adjusting Climate Control Settings

NOTE: Easily adjust your climate preferences, such as turning on the seat heater or changing the cabin temperature, hands-free by using voice commands (see [Voice Commands on page 17](#)).



Operating Climate Controls

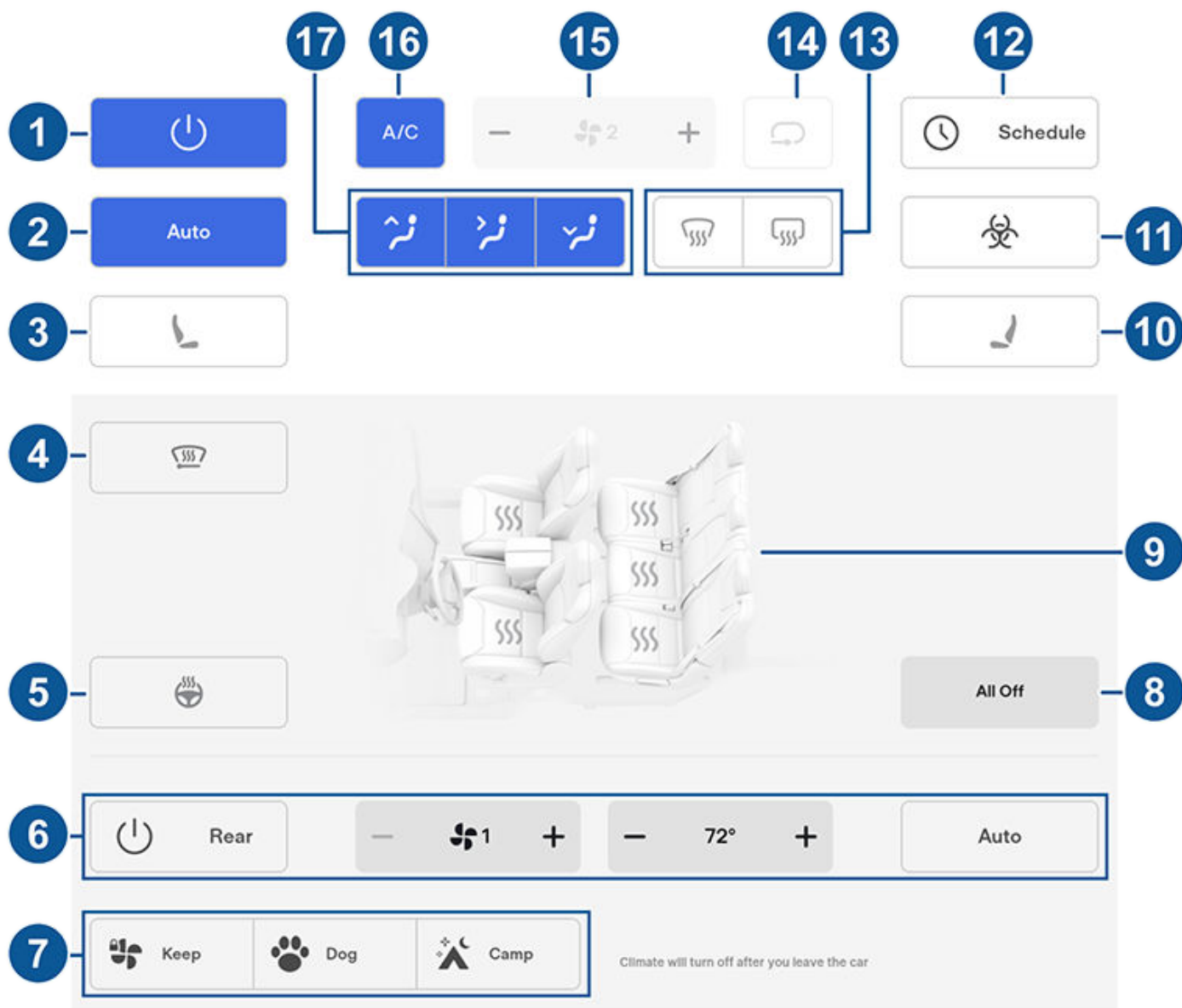

NOTE: For one-touch access to seat heaters and defrosters, you can add these controls to My Apps. See [Customizing My Apps](#) on page 7.

1. Touch to turn the climate control system on or off.
2. Touch **Auto** to turn the Auto setting on or off.
3. Touch the driver's side seat icon to adjust seat heaters for the driver. The seat operates at three levels from 3 (highest) to 1 (lowest). For one-touch access to seat heaters, you can add them to the touchscreen's bottom bar (see [Customizing My Apps](#) on page 7).
4. Touch to turn on the wiper defrosters (if equipped). Wipers defrost for 15 minutes then turn off automatically.
5. Touch to turn the heater on or off for the steering wheel (if equipped).
6. Touch to adjust the climate settings for the rear cabin. If set to **Auto**, the rear vents turn on automatically when the front climate system is on and a passenger is detected.
7. When in Park, these settings display to allow you to keep the climate control system operating, even when you leave Model X (see [Keep Climate On, Dog, and Camp](#) on page 152).
8. Touch to turn all seat heaters off.
9. Touch to adjust seat heaters for front and rear seats.



10. Touch the passenger's side seat icon to adjust seat heaters for the front passenger. The seat operates at three levels from 3 (highest) to 1 (lowest). For one-touch access to seat heaters, you can add them to the touchscreen's bottom bar (see [Customizing My Apps on page 7](#)).
11. If your Model X is equipped with the medical-grade HEPA (High Efficiency Particulate Air) filter, this filter ensures the best quality air inside the cabin whenever the climate control system is on and outside air is entering the cabin (recirculate is off). The HEPA filter is extremely effective at removing particles, including pollution, allergens, bacteria, pollen, mold spores, and viruses. Both the HEPA filter and the secondary filtration system also contain activated carbon to remove a broad spectrum of odors and gases. When you engage Bioweapon Defense Mode, the positive pressure inside the cabin minimizes the amount of outside air that can enter the vehicle.
NOTE: Some gases, such as carbon monoxide, are not effectively removed by activated carbon.
12. When Model X is in Park, touch **Schedule** to set a recurring daily time when you want Model X to be ready to drive by preconditioning the Battery and cabin climate and/or charging during off-peak hours (see [Scheduled Precondition and Charge on page 178](#)).
13. The windshield defroster distributes air flow to the windshield. Touch once to *defog* the windshield (the icon turns amber). Touch a second time to *defrost* the windshield. Touch a third time to turn off and restore the air distribution, heating, and fan to their previous settings.
14. Touch to control the flow of air inside the cabin. Air can be drawn into Model X from outside or air can be recirculated inside the cabin.
15. Use the slider to adjust the fan speed.
NOTE: Adjusting the fan speed may change the selected setting for how air is drawn into Model X in order to increase or reduce air flow.
16. Touch to turn the air conditioning system on or off. Turning it off reduces cooling, but saves energy.
NOTE: Because Model X runs much quieter than a gasoline-powered vehicle, you may notice the sound of the air conditioning compressor as it is operating. To minimize noise, reduce the fan speed.
17. Choose where air flows into the front cabin (windshield, face-level, or foot-level vents). You can choose one or more vents.



Operating Climate Controls

Climate Popup

Touch the temperature arrows on the bottom of the touchscreen to display a popup for easy access to some of the most common climate controls:

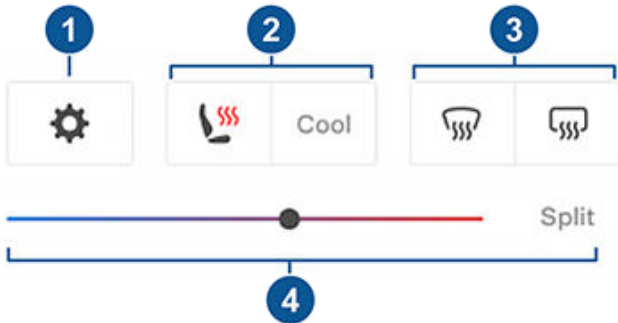

NOTE: For one-touch access to seat heaters and defrosters, you can add these controls to My Apps. See [Customizing My Apps on page 7](#).

1. Touch to access the main climate controls screen.
2. Enable or disable heated or cooled seats (if equipped).
3. Enable or disable the front or rear windshield defrosters.
4. Modify the cabin temperature by dragging the slider. You can also enable temperature splitting which allows the driver and front passenger to customize their own climate preferences. The front passenger can touch the temperature icon on the bottom of the touchscreen or the main climate controls screen to adjust. Touch **Split** again to disable climate splitting.

Keep Climate On, Dog, and Camp

The **Keep Climate On**, **Dog**, and **Camp** settings allow you to keep the climate control system running when in Park, even after you've left Model X or choose to stay inside the vehicle. These settings are useful when it is important to maintain the cabin temperature in hot or cold weather conditions. For example, when leaving groceries in Model X on hot days, you may want to use Keep Climate On to prevent spoilage.

Dog is designed to maintain a comfortable cabin temperature for your pet while you actively and frequently monitor this temperature using the mobile app (which requires both your phone and the vehicle to have cellular connectivity). When in Dog, the touchscreen displays the current cabin temperature to inform people passing by that your pet is safe. This setting is not intended for people, and should only be used for short periods of time while you stay in close proximity should you need to return to the vehicle in situations where the temperature can no longer be maintained.

Camp allows you to power electronics through the USB ports and low voltage outlet in addition to maintaining the cabin temperature. The touchscreen remains on so you can play music, browse the internet, play games in the arcade, or watch shows in Tesla Theater. You can also control media and climate settings from a paired phone. Camp is ideal for

remaining inside your vehicle, such as camping or staying with a child. While active, Sentry Mode and the vehicle alarm system are disabled. Walk-Away Door Lock is inactive.

To operate Keep Climate On, Dog, or Camp:

1. Make sure the Battery's charge level is at least 20%.
2. Engage Park. The **Keep Climate On**, **Dog**, and **Camp** settings are available only when Model X is in Park.
3. If necessary, adjust the climate settings.
4. On the climate controls screen, touch **Keep Climate On**, **Dog**, or **Camp**.





NOTE: You can also control **Dog** and **Camp** from the mobile app, by swiping up from the gray bar on the Climate screen.

The climate control system attempts to maintain your climate settings until you shift out of Park or manually turn it off. Avoid using Keep Climate On, Dog, or Camp when the Battery's charge level is low.

If **Keep Climate On**, **Dog**, or **Camp** are on, the Tesla mobile app attempts to repeatedly send notifications reminding you to check on anything that you have left in Model X if the Battery's charge level drops below 20%.

NOTE: Software updates cannot be performed when Keep Climate On, Dog, or Camp is active.

NOTE: The intrusion sensor (if equipped) automatically disables when Keep Climate On, Dog, or Camp is active. However, you can override this behavior and keep the intrusion sensor enabled. To do so, touch **Controls > Safety > Tilt/Intrusion** after enabling Keep Climate On, Dog, or Camp. However, note that keeping the intrusion sensor enabled while Keep Climate On, Dog, or Camp is active can trigger an alarm event as a result of air movement inside the cabin.

-  **WARNING:** Never leave a child unattended in your vehicle.
-  **WARNING:** Check local laws for any restrictions on leaving pets unattended in your vehicle.
-  **WARNING:** You are responsible for the safety of your dog or pet. Never leave them in Model X for long periods of time. Constantly monitor the vehicle temperature and their well-being. Make sure you have sufficient cellular coverage on your phone and time to return to the vehicle, if necessary.
-  **WARNING:** In the unlikely event that your climate control system needs service or is not working as expected, avoid using Keep Climate On, Dog, and Camp. Never rely on your vehicle to protect something irreplaceable.
-  **WARNING:** You can adjust and monitor the climate control system remotely using the mobile app. However, if you use the mobile app to turn off the climate control system, Keep Climate On, Dog, and Camp stop operating.



Cabin Overheat Protection

Cabin Overheat Protection prevents the cabin from getting too hot in scorching ambient conditions. While not necessary to activate whenever you leave Model X, the climate control system can reduce and maintain the temperature of your vehicle's cabin. This can prevent the cabin from getting too hot after leaving it parked in the sun, making the vehicle more comfortable when you return. Cabin Overheat Protection may take up to 15 minutes to enable once you exit the vehicle. This feature is intended for passenger comfort and has no impact on the reliability of your vehicle's components.

To turn on, touch **Controls > Safety > Cabin Overheat Protection** and choose:

- **On:** The air conditioning operates when the cabin temperature exceeds 40° C. Customizing temperatures may require the most recent version of the mobile app.
- **Off:** Disables Cabin Overheat Protection.

You can also enable Cabin Overheat Protection remotely through the mobile app by touching **Climate**. Swipe up on the bottom menu and select a setting under **Cabin Overheat Protection** (see [Mobile App on page 66](#)).

Cabin Overheat Protection operates until 12 hours has elapsed once you exit Model X, or until the Battery energy drops below 20%, whichever comes first. Using Cabin Overheat Protection requires energy from the Battery, which may decrease range.

NOTE: To enable **Cabin Overheat Protection, Tilt/Intrusion** must be turned off.

 **WARNING:** Due to automatic shut-off, extreme outside conditions, or other potential inability to maintain the selected temperature, the inside of the vehicle can become dangerously hot, even when Cabin Overheat Protection is enabled. If you experience temperatures exceeding the selected temperature repeatedly, contact Tesla service.

 **WARNING:** Never leave children or pets in the vehicle unattended. Due to automatic shut-off or extreme outside conditions, the inside of the vehicle can become dangerously hot, even when Cabin Overheat Protection is enabled.

Climate Control Operating Tips

- When you use the mobile app to turn on the climate control system, it automatically turns off when the charge level drops to 20%, or if two hours has passed. To cool or heat the cabin for a longer period of time, charge the vehicle and re-enable your climate control preference through the mobile app.
- To conserve energy, turn on Range Mode (if equipped) to limit the power of the climate control system (touch **Controls > Pedals & Steering > Range Mode**). Cabin heating and cooling may be less effective, but you can use seat heaters to provide warmth in colder climates.

- If the climate control system is louder than you prefer, manually reduce the fan speed.
- In addition to cooling the interior, the air conditioning compressor also cools the Battery. Therefore, in hot weather, the air conditioning compressor can turn on even if you turned it off. This is normal because the system's priority is to cool the Battery to ensure it stays within an optimum temperature range to support longevity and optimum performance.
- Even when not in use, you may hear Model X emit a whining noise or the sound of water circulating. These sounds are normal and occur when the internal cooling systems turn on to support various vehicle functions, such as maintaining the low voltage battery and balancing the temperature of the high voltage Battery.
- To ensure the climate control system operates efficiently, close all windows and ensure that the exterior grille in front of the windshield is free of ice, snow, leaves, and other debris.
- In very humid conditions, it is normal for the windshield to fog slightly when you first turn on the air conditioning.
- It is normal for a small pool of water to form under Model X when parked. Extra water produced by the dehumidifying process is drained underneath.
- To reduce the temperature in the cabin in hot weather conditions, the fan may turn on to vent the cabin when the vehicle is parked. This occurs only if the battery's charge level is above 20%.



Vents

To direct the flow of air inside Model X, move the interior vents up, down, or from side to side.

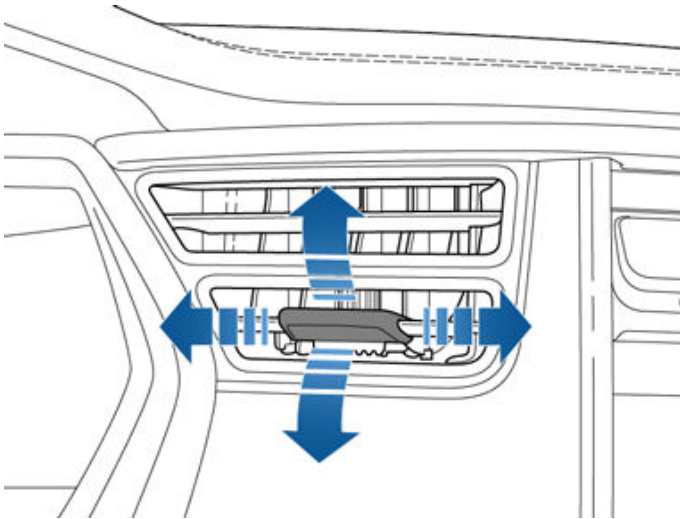

NOTE: You can direct the outer face level vents toward the side windows to help defrost or defog them.

Cabin Air Filter(s)

Model X has one or more air filters to prevent pollen, industrial fallout, road dust and other particles from entering through the vents.

NOTE: Cabin air filter(s) require periodic replacement. See [Service Intervals on page 183](#).



To ensure that Model X provides you with the best ownership experience possible in harsh cold weather conditions, follow these best practices.

Before Driving

When snow and ice accumulate on your vehicle, moving parts, such as the door handles, windows, mirrors, and wipers can freeze in place. To achieve maximum range and performance, it is helpful to warm the cabin and Battery before driving. There are several ways to do so:

- Touch **Controls** > **Schedule** (also available on both the charging and climate control screens) to set a time when you want your vehicle to be ready to drive (see [Scheduled Precondition and Charge on page 178](#)).
- In the mobile app, navigate to **Climate** to customize the temperature at which you want to heat the cabin. This also warms the high voltage Battery as needed.
- In the mobile app, navigate to **Climate** > **Defrost** to melt snow, ice, and frost on the windshield, windows, and mirrors. This also warms the high voltage Battery as needed.

NOTE: Tesla recommends activating climate settings at least 30–45 minutes before departure (see [Operating Climate Controls on page 149](#)). Preconditioning times depend on outside temperature and other factors. The mobile app will notify you once your vehicle has reached the desired preconditioning temperature.

Charge Port

If your charge port latch freezes in place and a charging cable becomes stuck in the charge port, touch **Controls** > **Service** > **Charge Port Heater**. If this does not work after several minutes, try manually releasing the charge cable. See [Manually Releasing Charge Cable on page 176](#).

In extremely cold weather or icy conditions, it is possible that your charge port latch may freeze in place. In cases where you cannot remove or insert the charge cable, or the vehicle is not Supercharging due to the latch being frozen in place, use the **Defrost Car** setting in the mobile app. This can help thaw ice on the charge port latch so the charge cable can be removed or inserted.

You can also prevent the occurrence of a charge port latch freezing in place by using the **Schedule** settings (see [Scheduled Precondition and Charge on page 178](#)).

NOTE: If your charge port latch is frozen in place, it may not lock the charging cable in place when inserted, but it can still charge at a slow AC rate even if the latch is not engaged.

Charging

By using Trip Planner (if available) to navigate to a Tesla charging location, Model X pre-heats the high voltage Battery to ensure when you arrive at the charger, the temperature of the Battery is optimal and ready to charge. This reduces the amount of time it takes to charge. See (see [Trip Planner on page 162](#)).

NOTE: Tesla recommends using Trip Planner to navigate to a charging location for at least 30–45 minutes before arrival to ensure optimal Battery temperature and charging conditions. If the drive to the charging location is less than 30–45 minutes, consider preconditioning the Battery before driving (see [Before Driving on page 155](#)).

Windows

In the mobile app, go to **Climate** and select **Defrost Car**, which helps melt snow, ice, and frost on the windshield, windows, and mirrors.

Use the mobile app to schedule a service appointment for Tesla to provide hydrophobic coating to the side and rear windows (not the front windshield) for a nominal fee.

Mirrors

If ice buildup is expected when parking, turn off **Auto-Fold Mirrors**. Touch **Controls** > **Vehicle** > **Auto-Fold**. Ice can prevent exterior side mirrors from folding or unfolding.

NOTE: Side mirrors automatically heat as needed during preconditioning, or when the rear defroster is turned on.

Wipers

If you expect snow or ice to build up when parked, touch **Controls** > **Service** > **Wiper Service Mode**. This raises the wipers against the windshield so they can defrost when the windshield defrosts (see [Wipers and Washers on page 85](#)). You can also turn on wiper defrosters (if equipped). See [Operating Climate Controls on page 149](#).

Tires and Tire Chains

Use winter tires to increase traction in snowy or icy conditions. You can purchase winter tires on the Tesla Shop (see [Seasonal Tire Types on page 189](#)).

Tire chains provide additional traction when driving in snowy or icy conditions. Check local regulations to determine if tire chains are recommended or required during winter months. See [Using Tire Chains on page 189](#) for more information.



Cold Weather Best Practices

Your vehicle's tire pressures will drop in cold ambient temperatures. If the TPMS indicator light appears, inflate the tires before driving. The tires will lose one PSI for every 6° C drop in outside temperature (see [Tire Care and Maintenance on page 185](#)). Proper tire pressures help protect tires from potholes and improve range when properly inflated.

While Driving

Cold weather can increase energy consumption because more power is required for driving, cabin and Battery heating. Follow these suggestions to reduce energy consumption:

- Use seat heaters to keep warm. Seat heaters use less energy than the cabin heater. Lowering the cabin temperature and using seat heaters reduces energy consumption (see [Operating Climate Controls on page 149](#)).
- Slow down your driving and avoid frequent and rapid acceleration.
- Turn on Range Mode (if equipped) to automatically limit the power that the climate control system uses to maintain the temperature of the Battery and the cabin area. Range Mode also turns off signature lights (if equipped) and adjusts the front and rear motor torque split to maximize range (see [Getting Maximum Range on page 180](#)).

Regenerative Braking

Regenerative braking can be limited if the Battery is too cold. As you continue to drive, the Battery warms up and regenerative power increases (see [Regenerative Braking on page 87](#)).

NOTE: Limited regenerative braking can be avoided if you allow enough time to precondition your vehicle or if you use **Schedule** to precondition Model X before your departure time (see [Scheduled Precondition and Charge on page 178](#)).

Cold Battery



A blue snowflake icon appears on your instrument panel when some of the stored energy in the Battery is unavailable because the Battery is cold. This portion of unavailable energy displays in blue on the Battery meter. Regenerative braking, acceleration, and charging rates may be limited. The snowflake icon no longer displays when the Battery is sufficiently warm.

After Driving

Leave Model X plugged in when not in use. This uses the charging system, rather than the Battery itself, to keep the Battery warm (see [High Voltage Battery Information on page 170](#)).

Scheduled Precondition

When parked, use the **Controls > Schedule** settings, available on both the charging and climate control screens, to set a time when you want to precondition Model X (see [Scheduled Precondition and Charge on page 178](#)). You can also use **Schedule** to prevent the charge port latch freezing in place. Your vehicle determines the appropriate time to begin preconditioning so that cabin and Battery are warm by your planned departure time.

Tesla recommends that you also schedule a charge with your precondition to ensure that your vehicle has sufficient energy for the trip. When Model X is not plugged in, preconditioning operates but only when the Battery's charge level is above 20%.

Storage

If you leave Model X parked for an extended period of time, plug the vehicle into a charger to prevent normal range loss and to keep the Battery at an optimal temperature. Your vehicle is safe to stay plugged in for any length of time.

When not in use, Model X enters a sleep mode to conserve energy. Reduce the number of times you check your vehicle's status on the mobile app, as this automatically wakes up your vehicle and starts normal energy consumption.



To ensure that Model X provides you with the best ownership experience possible in hot ambient conditions, follow these best practices.

Before Driving

There are several ways to prepare your vehicle for a drive, without having to get into an already hot vehicle:

- Precondition the cabin by moving the direction of air flow from the vents, and turn the seat heaters on or off. In the mobile app, navigate to **Climate** to customize the temperature at which you want to cool the cabin.
- Touch **Schedule**, available on both the Charging and Climate Control screens, to set a time when you want your vehicle to be ready to drive (see [Scheduled Precondition and Charge on page 178](#)).
- Enable **Cabin Overheat Protection**, which prevents the cabin from getting too warm in hot ambient conditions.
- In the mobile app, navigate to **Controls** to vent the windows.

NOTE: Tesla recommends activating climate settings at least 30–45 minutes before departure (see [Operating Climate Controls on page 149](#)). Preconditioning times depend on outside temperature and other factors. The mobile app will notify you once your vehicle has reached the desired preconditioning temperature.

After Driving

Leave Model X plugged in when not in use, especially if using Preconditioning or Cabin Overheat Protection. This uses the charging system, rather than the battery itself, to maintain a comfortable temperature (see [High Voltage Battery Information on page 170](#)). In addition, there are several ways to minimize a hot cabin:

- Before leaving your vehicle (to run errands, for example), use Dog Mode to keep the cabin cool for pets or perishable goods. See [Keep Climate On, Dog, and Camp on page 152](#) for more information.
- Tesla recommends turning the air conditioning off approximately 30 seconds before pressing Park to reduce puddling below the vehicle.
- Park in the shade to help reduce power consumption and maintain cooler cabin temperatures.
- Use a sun shade (available on the Tesla Shop) if you have to park outside in the sun.
- When parked, plug in Model X and **Schedule** your charging. Your vehicle determines the appropriate time to begin charging so it is complete during off-peak hours. The cabin and Battery are also prepared by your set departure time. For more information, see [Scheduled Precondition and Charge on page 178](#).

Charging

When using Trip Planner or navigating to a Supercharger station, your vehicle automatically prepares the Battery for most efficient charging. In extreme heat, you may not see the message that the vehicle is preconditioning the Battery while navigating to a Supercharger, but it is still preparing the Battery for charging.

NOTE: Tesla recommends using Trip Planner to navigate to a charging location for at least 30–45 minutes before arrival to ensure optimal Battery temperature and charging conditions. If the drive to the charging location is less than 30–45 minutes, consider preconditioning the Battery before driving (see [Before Driving on page 155](#)).

If possible, leave your vehicle plugged into a charger whenever not in use, even in warm weather, especially if using Preconditioning or Cabin Overheat Protection.

Storage

If you leave Model X parked for an extended period of time, plug the vehicle into a charger to prevent normal range loss and to keep the Battery at an optimal temperature. Your vehicle is safe to stay plugged in for any length of time.

When not in use, Model X enters a sleep mode to conserve energy. Reduce the number of times you check your vehicle's status on the mobile app, as this automatically wakes up your vehicle and starts normal energy consumption.



Maps and Navigation

Map Overview

The touchscreen displays a map at all times (except when Model X is shifted into Reverse).

Use your finger(s) to interact with the map:

- To move the map in any direction, hold and drag a finger.
- To rotate the map in any direction, hold and turn two fingers.
- To zoom the map in or out, expand or pinch two fingers, respectively.

NOTE: When you rotate or move the map, your current location is no longer tracked. The message "Tracking Disabled" displays briefly next to the map orientation icon and the icon turns gray. To re-enable tracking, touch the map's orientation icon and choose North Up or Heading Up.

NOTE: The map zooms in and out automatically when a navigation route is active.

To change the orientation of the map, toggle between these options:



North Up: North is always at the top of the screen.



Heading Up: The direction you are driving is always at the top of the screen. The map rotates as you change direction. This icon has an integrated compass that indicates the direction you are driving.

NOTE: Touching this icon while navigating to a destination displays the route overview.



Route overview is available when you are navigating to a destination and displays when you expand the turn-by-turn direction list (by swiping it downward). When you collapse the turn-by-turn direction list by swiping it upward, the map displays your previously chosen orientation.

Map Display

When Model X is in Park, the following icons display on the map to allow you to customize the type of information the map displays. To access these icons when driving, touch anywhere on the map (they disappear after a few seconds).



Satellite imagery (if equipped with premium connectivity).



Traffic conditions (if equipped with premium connectivity).



Map details (such as points of interest).

Drop a pin anywhere on the map by pressing and holding your finger on a desired location. When you drop a pin, or touch an existing pin, the chosen location is centered on the map and a popup screen provides information about the location. From this popup, you can navigate to the location add or remove the location from your list of favorite destinations (see [Home, Work, and Favorite Destinations on page 160](#)).



Charging locations. Shows a popup list that includes the city and proximity of the corresponding stations on the map. Charging locations include Tesla Superchargers, destination charging sites, third-party fast chargers, and public chargers that you have used previously. See [Charging Locations on page 161](#). Touch the lightning bolt icons in the popup list to filter by the types of chargers based on max power.

NOTE: In some market regions, third-party fast chargers are also included on the map as dark gray pins when you display chargers.

Navigation Settings

NOTE: The navigation settings available can vary depending on region and vehicle configuration.



The navigation settings icon displays when you touch ... once you start navigating to a destination.

NOTE: You can also access navigation settings by touching **Controls > Navigation**.

Touch the navigation settings icon to customize the navigation system to suit your preferences (the available settings vary depending on your market region and vehicle configuration):

- **Navigation Guidance:** Touch **Voice** to enable an audible reading for navigation instructions.



- Touch **-** or **+** to increase or decrease the volume of spoken navigation instructions. Decreasing all the way to the left or touching the speaker icon mutes the instructions. You can also mute/unmute navigation instructions by touching the speaker icon. This volume setting applies only to the navigation system's spoken instructions. Volume for Media Player and Phone does not change.

NOTE: Volume may automatically be adjusted based on driving speed and climate settings.

NOTE: Navigation instructions are muted when the paired phone has an ongoing phone call.

- Enable **Automatic Navigation** if you want Model X to automatically initiate a navigation destination when you get in your vehicle. Destinations are predicted based on commonly driven routes, time of day, and calendar entries (see [Automatic Navigation on page 160](#)).
- Enable **Trip Planner** (if available in your market region) to add Supercharger stops as needed. Supercharging stops are added to navigation routes with the goal of minimizing the amount of time you spend driving and charging (see [Trip Planner on page 162](#)).
- Enable **Online Routing** to automatically route to avoid heavy traffic (see [Online Routing on page 162](#)).
- Touch **Avoid Ferries** to be automatically routed to avoid ferries.
- Touch **Avoid Tolls** to be automatically routed to avoid tolls, if possible.

Navigating to a Destination

To navigate to a location, touch the search bar in the corner of the map and enter a destination, send the destination from your phone, or use voice commands (see [Voice Commands on page 17](#)) for an address, landmark, business, etc. If the destination you choose has other destinations within it (such as terminals at an airport), you can also choose a sub-destination.

Touch the search bar for different options:

- Refresh a search when you zoom in or drag to a different area of the map by tapping **Search this area** when prompted (if available in your region).
- Choose a saved **Home** or **Work** location (see [Home, Work, and Favorite Destinations on page 160](#)).
- Select a **Charging** destination (see [Charging Locations on page 161](#)).
- Pick from **Recent** destination (the most recent destination is listed at the top).
- Choose a destination you have marked as a **Favorite** (see [Home, Work, and Favorite Destinations on page 160](#)).
- A popular restaurant when you're feeling **Hungry** or a popular destination (such as museums and amusement parks) when you're feeling **Lucky** (see [Lucky and Hungry on page 160](#)).

NOTE: You can start navigation remotely from your IOS® or Android™ device using the "share" functionality on your device after allowing access to the Tesla mobile app.

When you specify a location, the touchscreen zooms out to provide an overview of the route you need to travel and displays a turn-by-turn direction list. Estimated arrival time, driving time, and mileage displays at the bottom of the direction list. Note the following about the turn-by-turn direction list:

- The Battery icon on the turn list provides a visual representation showing an estimate of how much energy will remain when you reach your destination, and how much will remain if you make a round trip back to your current location. See [Predicting Energy Usage on page 162](#).
- If charging is needed to reach your destination and Trip Planner is enabled (and available in your market region), the navigation route automatically includes Supercharger stops (see [Trip Planner on page 162](#)).
- If you won't have enough energy to reach your destination and there is no Supercharger on the route, an alert tells you that charging is needed to reach your destination.
- Each turn is preceded by the distance to the maneuver.
- To see the bottom of the list, you may need to drag the list upward.
- Touch the top of the list to minimize it.

After setting a destination, the search bar gives you the option to **Search Along Route** to add stops (see [Adding Stops to a Route on page 160](#)).

While navigating, the map tracks your location and displays the current leg of your trip. You can display the entire route at any time by swiping down to expand the turn-by-turn direction list or touching the route overview icon.

Below the turn-by-turn list, a progress bar shows how close you are to your destination or next stop. If online routing is enabled, the progress bar also shows live traffic conditions on your route (see [Online Routing on page 162](#)).

To stop navigating, touch **Cancel**, located in the bottom corner of the turn-by-turn direction list. Swipe right on the suggested location or press and hold the location to quickly delete certain recent navigation searches.

NOTE: If a data connection is not available, onboard maps allow you to navigate to any destination, but you must enter the exact and complete address.

Selecting an Alternate Route

Depending on market region and vehicle configuration, this feature may not be available on your vehicle. Your vehicle must be equipped with Premium Connectivity.



Maps and Navigation

After you have entered a destination with one stop, the map displays up to three alternate routes. This allows you to easily compare total travel time and traffic information for each route. If you do not select a preferred route within the timeout period, the fastest route is automatically selected.

Adding Stops to a Route

After entering a destination, edit your route by adding, deleting or reordering stops. Touch the three dots at the bottom of the turn-by-turn direction list to view options to edit your route.



Add Stop allows you to add a stop by searching for a location or adding a Home, Recent or Favorite destination. When you search, locations near your route are shown along with the detour time to reach them. You can also add a stop by touching any pin on the map and selecting **Add** from the popup.



Edit Stop allows you to set up a complex trip by adding or deleting stops on your route. Drag and drop stops by touching the equal sign to reorder your trip.

You can also use the Tesla mobile app to edit your route (if available in your region). In the Tesla mobile app, go to **Locations > Navigate** and enter a destination, touch **Edit Trip > Add Stop** to edit your route, then touch **Send to Car** to share the trip with your vehicle.

NOTE: Requires Tesla mobile app version 4.27.5 or newer.

Automatic Navigation

NOTE: *Automatic Navigation may not be available in all market regions and on all vehicle configurations.*

Automatic Navigation can predict a destination when you get in your vehicle. When your phone's calendar is synced to Model X, and the calendar includes an event that takes place within two hours of when you get in your vehicle to drive, Automatic Navigation suggests the location of the event (assuming a valid address is associated with the event).

In addition, if you are Home and drive on weekdays (Monday to Friday) from 5:00 AM to 11:00 AM, Automatic Navigation can automatically route you to your specified Work location (see [Home, Work, and Favorite Destinations on page 160](#)). Likewise, if you are at work on weekdays from 3:00 PM to 11:00 PM, Automatic Navigation can automatically route you to your specified Home location.

To enable Automatic Navigation, touch **Controls > Navigation > Automatic Navigation**. You must have your phone's calendar synced to Model X and the event must include a uniquely specified and valid address (see [Phone, Calendar, and Web Conferencing on page 71](#)).

NOTE: Navigation instructions that you enter manually, or send to Model X, override routes suggested by Automatic Navigation.

Lucky and Hungry

NOTE: *Features may not be available in all market regions and on all vehicle configurations.*

In addition to navigating to a destination of your choice, Model X can also suggest nearby locations based on whether you are feeling **Hungry** or **Lucky**. In the navigation search bar, touch **Hungry** or **Lucky**. **Hungry** suggests a list of popular restaurants, whereas **Lucky** suggests a list of popular destinations (such as museums and amusement parks). Once you discover an interesting destination, touch **Navigate** to proceed to the destination.

This feature requires the latest version of Navigation maps. To download, connect Model X to Wi-Fi and touch **Controls > Software** to check if an update is available (see [Map Updates on page 162](#)).

Home, Work, and Favorite Destinations

If you frequently drive to a destination, add it as a favorite to avoid entering the location's name or address each time. When you add a destination as a Favorite, you can easily navigate to it by touching the navigation search bar and then touching **Favorites** and choosing it from your list of favorite destinations.



To add a destination to your Favorites list, touch its pin on the map, then touch the star icon on the popup screen that appears. Enter a name (or leave as-is to accept the default name), then touch **Add to Favorites**. The star becomes solid and the destination is included on your Favorites list.

To delete a Recent or Favorite destination, touch it on the destination list and hold it down briefly until the **X** appears. Then touch the **X** to delete it from the list.

Home and **Work** locations also display under the navigation search bar. Touch to set an address to the corresponding location. After entering the address, touch **Save as Home** or **Save as Work**. Then simply touch these shortcuts whenever you want to navigate home or to work.

To change or delete the corresponding address, press and hold the **Home** or **Work** icon. A popup allows you to enter a new address and **Save as Home** or **Save as Work**. Once a Home or Work location is saved, Model X may prompt you to navigate to your Work location in the mornings and to your Home location in the evenings and provide an estimated driving time based on current traffic conditions. See [Automatic Navigation on page 160](#). Touch **Clear Home** or **Clear Work** to remove associated addresses entirely. Based on your usage patterns, Model X may prompt you to save a location as Home or Work.



For security reasons, if you sell, transfer ownership, or allow others to drive Model X, it is recommended that you delete your Home and Work locations. You can delete these individually or you can perform a factory reset to erase all personal data (touch **Controls** > **Service** > **Factory Reset**).

Charging Locations

To display charging locations on the map, touch the map's search bar, then touch **Charging**. Charging locations are shown in a list (with the closest charging location at the top of the list) and represented by corresponding pins on the map. Touch a pin to display more information, navigate to, or mark it as a favorite.

Touch the lightning bolt icons to specify the types of charging locations you want the map to include (by default, the map displays only Superchargers):



Touch to include low power stations up to 25 kW, such as destination charging locations.



Touch to include medium power chargers 25 kW to 75 kW.



Touch to include high power chargers 75 kW and above.

NOTE: In some market regions, third-party fast chargers are also included as dark gray pins when you choose to display all charging stations.

The appearance of a charging location's pin reveals the predicted status about the location. Touch the pin to display details.



The Supercharger location is operational and the number displayed on the pin represents the predicted number of available Supercharger stalls upon arrival.

NOTE: A Supercharger located on your current navigation route is colored black (or white, if the touchscreen is in night mode).



The Supercharger location is predicting a high volume of users. You may need to wait before charging.



The Supercharger location may be operating at a reduced capacity.



The Supercharger location may be closed.



The Supercharger location has no data available but should be operational.



The location is either a destination charging location, a third-party fast charger, or a public charging station that you have previously used. Touch to display more information such as usage restrictions and available charge current.

NOTE: When the map is zoomed out and more than one destination charging location is available in an area, the pin is round and displays the number of stations. Touch the pin to zoom in. Then you can touch an individual pin for details about a specific location.

Touch a charging location's pin to display a popup from which you can:

- Determine its exact location and approximate distance from your current location.
- Determine if a Supercharger location is trailer friendly. A trailer-friendly Supercharger location includes Supercharger stalls that allow you to pull through and charge while a trailer is attached to your vehicle.
- View amenities that are available at the charging location, including restrooms, restaurants, lodging, shopping, and Wi-Fi. On a Supercharger popup, touch an amenity icon to search the surrounding area for the associated amenity.
- Touch the arrow icon to navigate to the charging location.

NOTE: When navigating to a Supercharger (or third-party fast charger in some regions), Model X preconditions the Battery to prepare for charging. This ensures you arrive with an optimal Battery temperature, reducing the amount of time it takes to charge. In some circumstances (such as cold weather), it is normal for the motor(s) and components to make noise as it generates heat to warm the Battery (see [Charging on page 155](#)).



- View how busy a Supercharger location typically is during different times of the day, along with corresponding charging fees and idle fees (see [Supercharger Fees on page 176](#)).

Predicting Energy Usage

When navigating to a destination, Model X helps you anticipate your charging needs by calculating the amount of energy that remains when you reach your destination. When navigating, the map displays this calculation next to the Battery icon on the turn-by-turn direction list (see [Navigating to a Destination on page 159](#)). When the turn-by-turn direction list is compressed, touch the top of the list to expand it.

The calculation that predicts how much energy you will use is an estimate based on driving style (predicted speed, etc.) and environmental factors (wind speed and direction, ambient and forecasted temperatures, air density and humidity, etc.). As you drive, Model X continuously learns how much energy it uses, improving accuracy over time. Model X predicts energy usage based on the driving style of the individual vehicle. For example, if you drive aggressively for a period of time, future range predictions will assume higher consumption. Some factors that contribute to predicted energy (such as forecasted temperatures and wind speed) are available only when Model X has internet connectivity.

NOTE: If you purchase a used Tesla vehicle, it is recommended that you perform a factory reset (**Controls > Service > Factory Reset**) to ensure the predicted energy is as accurate as possible.

Throughout your route, Model X monitors energy usage and updates the estimate of energy remaining at the end of your trip. A popup warning displays on the turn-by-turn direction list in these situations:

- A yellow warning displays when you have very little energy remaining to reach your destination, requiring you to drive slowly to conserve energy. For tips on conserving energy, see [Getting Maximum Range on page 180](#).
- A red warning displays when you must charge to reach your destination.

To determine if you have enough energy for a round trip, touch the Battery icon on the turn-by-turn direction list to display an estimated calculation of your round trip energy usage.

Online Routing

Model X detects real-time traffic conditions and automatically adjusts the estimated driving and arrival times. In situations where traffic conditions may delay your estimated time of arrival and an alternate route is available, the navigation system can reroute you to your destination. To decline the alternate route, tap the reroute notification on your touchscreen. You can also specify the minimum number

of minutes that must be saved before you are rerouted. Turn this feature on or off by touching **Controls > Navigation > Online Routing**.

Trip Planner

Trip Planner (if available in your region) helps you take longer road trips with confidence. If reaching your destination requires charging, Trip Planner routes you through the appropriate Supercharger locations. Trip Planner selects a route and provides charging times to minimize the amount of time you spend driving and charging. To enable Trip Planner, touch the map's settings icon (see [Navigation Settings on page 158](#)), then touch **Trip Planner**.

When Trip Planner is enabled and charging is required to reach your destination, the turn-by-turn direction list includes Supercharger stops, recommended charging times at each Supercharger, and an estimate of how much energy will be available when you arrive at the Supercharger location.

To remove Supercharger stops and display directions only, touch **Remove all charging stops** at the bottom of the turn-by-turn direction list. If you remove charging stops, the turn-by-turn direction list may display an alert indicating that charging is needed to reach your destination. To add Supercharger stops back to the turn-by-turn direction list, touch **Add charging stops**.

While charging at a Supercharger, the charging screen displays the remaining charging time needed to drive to your next Supercharger stop or destination (if no further charging is needed). If you charge for a shorter or longer length of time, charging time at subsequent Supercharger stops is adjusted accordingly. You can also use the mobile app to monitor remaining charging time needed.

NOTE: When navigating to a Supercharger or, in some regions, a third-party fast charger using Trip Planner, Model X may allocate some energy to pre-heat the Battery to arrive at the Supercharger or third-party fast charger with an optimal Battery temperature. This reduces charging time (see [Charging on page 155](#)).

If Trip Planner estimates that you won't have enough energy for your round trip, and there are no Superchargers available on your route, Trip Planner displays an alert at the top of the turn-by-turn direction list notifying you that charging is needed to reach your destination.

NOTE: If a Supercharger on your navigation route experiences an outage, Trip Planner displays a notification and attempts to reroute you to a different Supercharger location.

Map Updates

As updated maps become available, they are automatically sent to Model X over Wi-Fi. To ensure you receive them, periodically connect Model X to a Wi-Fi network (see [Wi-Fi on page 68](#)). The touchscreen displays a message informing you when new maps are installed.

Overview

NOTE: Media apps vary depending on market region, vehicle configuration, options purchased, and software version. Some apps described may not be available in your market region, or may be replaced by different ones.

The Media Player displays on the touchscreen and is used to play various types of media. You can drag Media Player upward to expand it (allowing you to browse), and downward to minimize it so that just the Miniplayer displays. The convenient Miniplayer, which occupies the least amount of space on the touchscreen, displays what's currently playing and provides only the basic functions associated with what's playing.

When you play audio through the web browser and then minimize the browser, Model X continues the browser audio in the background. You can pause or play the browser audio through the media Miniplayer. If there was media playing before the browser audio began, the media resumes after you pause or end browser audio.

Streaming services are available only when a data connection is available (for example, Wi-Fi or Premium Connectivity). For some media services, you can use a default Tesla account. For others, you may need to enter account credentials the first time you use it.

NOTE: Instead of launching a different media app, you can change the source from within the Media Player screen by choosing a source from the dropdown list.



Radio: Choose from a list of available radio stations or touch the numeric keypad to directly tune the radio to a specific frequency. Touch the next or previous arrows to move from one frequency to the next (or previous).



Bluetooth: Play audio from a bluetooth-connected phone or USB device (see [Playing Media from Devices on page 164](#)).

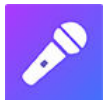

Caraoke (if equipped): Sing along with various songs (see [Caraoke on page 164](#)).

NOTE: You can show or hide any media app/source. See [Media Settings on page 163](#).

Model X supports these media apps, if available in your region:

- Amazon Music
- Apple Music
- Apple Podcasts
- Audible
- LiveOne
- Spotify

- TuneIn
- YouTube Music

When listening to internet radio or a music streaming service, the options available on the Media Player screen vary depending on what you are listening to. Touch the next (or previous) arrows to play the next (and in some cases previous) available station, episode, or track. You can also play next/previous using the left scroll button on the steering wheel.

NOTE: You can use voice commands to adjust media settings and preferences, such as volume control, playing certain songs, or switching the media source (see [Voice Commands on page 17](#)).

Volume Controls

Volume can be controlled by:

- Roll the scroll button on the left side of the steering wheel up or down to increase or decrease volume respectively. This adjusts the volume for media, voice commands, and phone calls.
- Volume may be adjusted based on your driving speed and climate settings.
- Touch the <> arrows associated with the speaker icon on the bottom corner of the touchscreen.
- To mute the volume, press the left scroll button. Press again to unmute.
- Pressing the left scroll button during a phone call mutes both the sound and your microphone.

Media Settings

NOTE: The settings available vary depending on market region. Also, a setting may not be applicable to all audio sources.



Press the settings icon located in the Media Player's search bar to access audio settings.

You can adjust these settings:

- **Tone:** Drag the sliders to adjust the subwoofer and any of the five frequency bands (Bass, Bass/Mid, Mid, Mid/Treble, and Treble). If equipped with premium audio, you can adjust the level of sound immersion to make your music experience more engaging by dragging the immersive sound slider according to your preferences.
- **Balance:** Drag the center circle to the location in Model X where you want to focus the sound.
- **Options:** Set preferences for optional features. For example, you can turn **DJ Commentary**, **Explicit Content** and **Allow Mobile Control** on or off.



- **Sources:** Displays all available media sources and allows you to choose whether you want to show or hide each source. You may want to hide media sources that you never use. Once hidden, the media source does not appear on the drop down list in Media Player, nor will it appear in the app tray when you touch the App Launcher. You can re-display a hidden media source at any time by returning to this settings screen.



Your recently played selections are updated continuously so you don't need to remove them.

NOTE: Selections you play on FM (if equipped) radio are not included in the Recents list.

Searching Audio Content



Touch Media Player's magnifying glass icon to search for a particular song, album, artist, podcast, or station. You can also use voice commands to search hands-free (see [Voice Commands on page 17](#)).

Caraoke

NOTE: Depending on vehicle configuration and market region, Caraoke may not be available on your vehicle. Caraoke requires premium connectivity.

Navigate to Media Player and select the drop down menu to change the media source to Caraoke. Or add Caraoke as an app in the app launcher. You can browse through various songs and select the song you want to sing. Touch the microphone icon to enable or disable the song's main vocals. Disabling the microphone leaves only the song's instrumentals and background vocals. Touch the lyrics icon (located next to the microphone icon) to enable or disable the song's lyrics.



WARNING: Never read Caraoke lyrics while driving. You must always pay attention to the road and traffic conditions. When driving, the Caraoke lyrics are intended only for use by a passenger.

Recents and Favorites

For most source content, recents and favorites display at the top for easy access.



To add a currently playing station, podcast, or audio file to your Favorites list, touch the **Favorites** icon on Media Player.



To remove an item as a favorite, touch the highlighted **Favorites** icon. You can also remove multiple favorites by expanding Media Player to show all favorites for the applicable type of source content. Then press and hold any favorite. An **X** appears on all favorites and you can then touch the **X** to remove them from your Favorites list.

Playing Media from Devices

USB Flash Drives

Insert a flash drive into a front USB port (see [USB Ports on page 10](#)). Touch **Media Player** > **USB**, then touch the name of the desired folder. To play media from a USB connection, Model X recognizes flash drives only. To play media from other types of devices (such as an iPod), you must connect the device using Bluetooth (see [Bluetooth Connected Devices on page 164](#)).

NOTE: Media Player supports USB flash drives with exFAT formatting (NTFS is not currently supported).

NOTE: Use a USB port located at the front of the center console. The USB connections at the rear of the console are for charging only.

Bluetooth Connected Devices

Pair your Bluetooth-capable device to Model X (see [Bluetooth on page 69](#)) to play stored audio files. Choose Media Player's **Phone** source, touch the name of your Bluetooth-connected device, then touch **CONNECT**.



Overview

NOTE: Entertainment options may vary depending on market region, date of manufacture, and vehicle configuration.



Theater: Play various video streaming services (such as Netflix, YouTube, Hulu, etc.) while parked. Available only if Model X is connected to WiFi, or is equipped with premium connectivity and a cellular signal is available.



Arcade: Want to game? You may need to use the steering wheel buttons or a Bluetooth or USB controller to play. See [Gaming Controllers on page 167](#).



Toybox: Play in the Toybox while parked.



WARNING: Use these features only when Model X is parked. Always pay attention to road and traffic conditions when driving. Using these features while driving is illegal and very dangerous.

NOTE: You can also use voice commands to access these features (see [Voice Commands on page 17](#)).

Toybox

Your vehicle's toybox includes features that can be fun to use. Here's an example of the types of features you can find in Toybox:

Select This...	To Do This...
007	You are no longer a "Driver", you're a "Diver"! Touch Controls > Suspension to change your depth.
Boombox	If Model X is equipped with a Pedestrian Warning System, delight pedestrians with a variety of sounds from your vehicle's external speaker while in Park. See Boombox on page 166 for more details. NOTE: Check local laws before using Boombox in public areas.
Emissions	Fun can come in surprising ways. Select your preferred fart style and target seat. Use your turn signal or press the left scroll wheel when you're ready to "release" your prank. For those lucky vehicles equipped with a Pedestrian Warning System, you can choose to broadcast externally when your vehicle is parked. But wait-- the fun doesn't stop there! Use the mobile app to conduct remote emissions testing by touching and holding any of the four quick control buttons and selecting the fart button.
Model Xmas	Park outside, turn the volume up, roll down your windows, then enjoy the show. Schedule the light show for a future time and customize the song to surprise your loved ones.
Ludicrous Speed (P100D vehicles only)	Press and hold the Ludicrous setting (touch Controls > Pedals & Steering > Acceleration > Ludicrous) for approximately five seconds. Touch Yes, bring it on! if you want to go fast. To display power and acceleration readings on the instrument panel, press either scroll button briefly until the available options are displayed. Then, roll the scroll button to highlight Readout then press the scroll button again.
Mars	The map shows your Model X as a rover on the Martian landscape, and the About Your Tesla box displays SpaceX's interplanetary spaceship.
Rainbow Charge Port	When Model X is locked and charging, press the button on the mobile connector ten times in quick succession. Neat, huh?
Rainbow Road	Need more cowbell? Visit Rainbow Road by pulling the Autopilot stalk toward you four times in quick succession while Autosteer is enabled.



Theater, Arcade, and Toybox

Romance	You can't roast chestnuts by an open fire in your car, but you can still cozy up with your loved ones by this virtual fireplace. Cue the music and get your romance on!
Sketchpad	Channel your inner Picasso. Show us what you got! Touch Publish to submit your artistic compositions to Tesla for critiquing.
TRAX	It's never too late to follow your dream of becoming a world-famous DJ. With TRAX, you can turn your vehicle into your own personal music studio. While in Park, choose from an array of instruments and unique sounds to create the next hit song. Microphone and headset are not included.
The Answer to the Ultimate Question of Life, The Universe, and Everything	Rename your vehicle to 42 (touch Controls > Software and touch the vehicle's name). Notice the new name.
Car Colorizer (if equipped)	Change the color of your Model X on the touchscreen. Touch the color swatch next to the vehicle name and customize the exterior color, tone, and more.

Boombox

NOTE: Boombox is available only on vehicles equipped with the Pedestrian Warning System (PWS).

NOTE: Check local laws before using Boombox in public places.

Using Boombox, you can play sound externally through the Pedestrian Warning System (PWS) speaker when Model X is in Park. For example:

- **Play current media.**
- Use **Megaphone** to project a modulated version of your voice.
- Press the horn to play the first five seconds of any sound from a compatible USB device.

NOTE: If Camp mode is enabled in Climate Controls, you can exit the vehicle and use the Tesla app to control the volume.

Prepare a USB drive for Boombox

Follow these steps to add up to five custom Boombox sounds:

1. On a computer, format a USB drive to exFAT, MS-DOS FAT (for Mac), ext3, or ext4 (NTFS is currently not supported).
2. Create a folder on the USB drive called **Boombox**.

NOTE: The USB drive can only contain one folder. For example, it cannot be shared with Dashcam.

3. Add .wav and .mp3 audio files to the folder. Although you can add as many files as the USB drive's capacity allows, you can only select from the first five, as listed alphabetically. File names, of any length, can contain upper or lower case alpha characters (a-z/A-Z), numbers from 0-9, periods (.), a dashes (-), and underscores (_).
4. Plug the USB drive into a front USB port.
5. Choose a sound from the USB drive by selecting from the **Boombox** dropdown menu.

Uninstall Games

Uninstalling games is useful if you want to free up your vehicle's onboard storage. To uninstall a game, navigate to **Arcade**, select the game you wish to uninstall, then touching **Uninstall**. Once you uninstall a game, you must download it before you can play the game again.



Gaming Controllers

You can pair Bluetooth Classic gaming controllers to Model X by following the same steps as pairing your phone (see [Phone, Calendar, and Web Conferencing on page 71](#)). After pairing, the controller automatically connects to the vehicle. Once connected, you can use the controller to play select games. Model X supports up to two Bluetooth devices at a time (such as two controllers, or one phone and one controller).

For vehicles manufactured prior to approximately November 1, 2021, you can connect USB-compatible game controllers to the front USB ports in the vehicle's center console. For vehicles manufactured after approximately November 1, 2021, you must use the glovebox USB port.



High Voltage Components

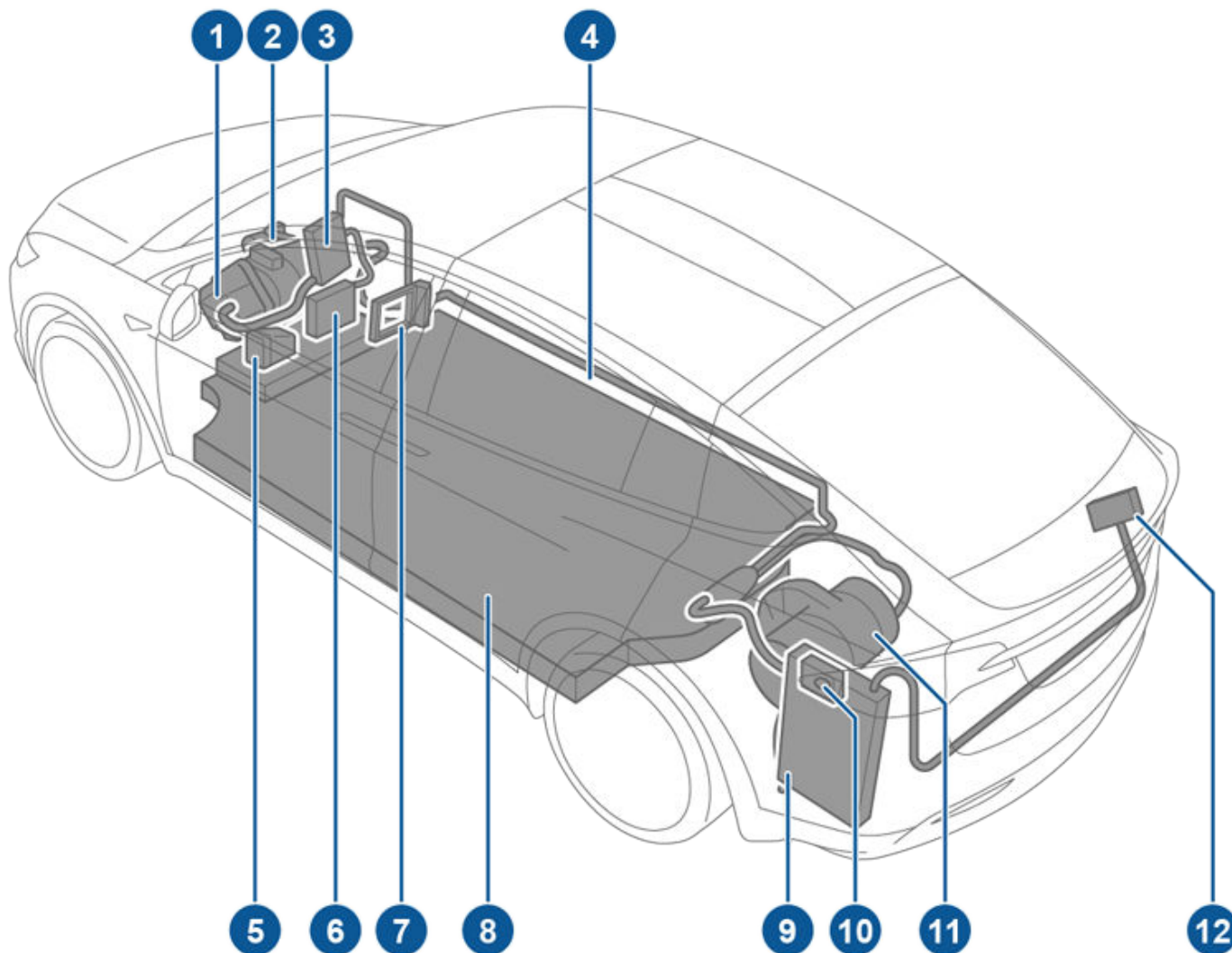

1. Front Motor
2. Air Conditioning Compressor
3. Forward Junction Box
4. High Voltage Cabling
5. Battery Coolant Heater
6. DC-DC Converter
7. Cabin Heater
8. High Voltage Battery
9. On-board Charger
10. Charge Port
11. Rear Motor
12. HV Cable to Rear HVAC Assembly

⚠ WARNING: The high voltage system has no user serviceable parts. Do not disassemble, remove or replace high voltage components, cables or connectors. High voltage cables are typically colored orange for easy identification.



 **WARNING:** Read and follow all instructions provided on the labels that are attached to Model X. These labels are there for your safety.

 **WARNING:** In the unlikely event that a fire occurs, immediately contact your local fire emergency responders.

Charging Equipment

Charging equipment designed specifically to charge your Model X is available from Tesla.

For information on the charging equipment **available for your region**, go to <http://shop.tesla.com>.

- A Wall Connector, which installs in your parking space, is the fastest way to charge your vehicle for daily use.
- A Mobile Connector allows you to plug into most commonly used power outlets. When using the Mobile Connector, attach the smart adapter (if required) to the Mobile Connector before plugging it in to the power outlet, and then plug in your vehicle.
- Tesla also offers adapters that allow you to plug into the most commonly used public charging stations in your region. At a public charge station, first attach the adapter to the station's charging connector and then plug in your vehicle.



High Voltage Battery Information

Model X has one of the most sophisticated battery systems in the world. The most important way to preserve the high voltage Battery is to **LEAVE YOUR VEHICLE PLUGGED IN** when you are not using it. This is particularly important if you are not planning to drive Model X for several weeks.

NOTE: When left idle and unplugged, your vehicle periodically uses energy from the Battery for system tests and recharging the low voltage battery when necessary.

There is no advantage to waiting until the Battery's level is low before charging. In fact, the Battery performs best when charged regularly.

NOTE: If you allow the Battery to discharge to 0%, other components may become damaged or require replacement (for example, the low voltage battery). In these cases, you are responsible for repair and/or transporting expenses. Discharge-related expenses are not covered by the warranty or under the Roadside Assistance policy.

The peak charging rate of the Battery may decrease slightly after a large number of DC Fast Charging sessions, such as those at Superchargers. To ensure maximum driving range and Battery safety, the Battery charge rate is decreased when the Battery is too cold, the Battery's charge is nearly full, and when the Battery conditions change with usage and age. These changes in the condition of the Battery are driven by battery physics and may increase the total Supercharging duration by a few minutes over time. You can minimize the amount of charge time by using Trip Planner (if available in your market region) to warm the Battery while driving to a Supercharger. See [Trip Planner on page 162](#) for more information.

Battery Care

Never allow the Battery to fully discharge.

Even when Model X is not being driven, its Battery discharges very slowly to power the onboard electronics. The Battery can discharge at a rate of approximately 1% per day, though the discharge rate may vary depending on environmental factors (such as cold weather), vehicle configuration, and your selected settings on the touchscreen. Situations can arise in which you must leave Model X unplugged for an extended period of time (for example, at an airport when traveling). In these situations, keep the 1% in mind to ensure that you leave the Battery with a sufficient charge level. For example, over a two week period (14 days), the Battery may discharge by approximately 14%.

Discharging the Battery to 0% may result in damage to vehicle components. To protect against a complete discharge, Model X enters a low-power consumption mode when the displayed charge level drops to approximately 0%. In this mode, the Battery stops supporting the onboard electronics and auxiliary low voltage battery. Once this low-power consumption mode is active, immediately plug in Model X to prevent a jump start and low voltage battery replacement.

NOTE: If Model X is unresponsive and does not unlock, open, or charge, the low voltage battery may be discharged. In this situation, try jump starting the low voltage battery (see [Jump Starting on page 218](#)). If the vehicle is still unresponsive, use the mobile app to schedule a service appointment.

Temperature Limits

For better long-term performance, avoid exposing Model X to ambient temperatures above 60° C or below -30° C for more than 24 hours at a time.

Energy Saving Feature

Model X has an energy-saving feature that reduces the amount of energy being consumed by the displays when Model X is not in use. On newer vehicles, this feature is automated to provide an optimal level of energy saving. However, on older vehicles, you can control the amount of energy being consumed by the displays by touching **Controls > Display > Energy Saving**. For more information on maximizing range and saving energy, see [Getting Maximum Range on page 180](#).

Submerged Vehicle

As with any vehicle, if your Tesla has been exposed to flooding, extreme weather events or has otherwise been submerged in water (especially in salt water), treat it as if it's been in an accident. See [Submerged Vehicle Guidance on page 220](#) for more information.

NOTE: Damage caused by water is not covered under warranty.

Battery Warnings and Cautions



WARNING: The high voltage system must be serviced **only** by a trained technician. Under no circumstances should you open or tamper with the Battery. Do not disassemble, remove or replace high voltage components, cables or connectors. High voltage cables are typically colored orange for easy identification.



CAUTION: If the Battery's charge level falls to 0%, you must plug it in. If you leave it unplugged for an extended period, it may not be possible to charge or use Model X without jump starting or replacing the low voltage battery. Leaving Model X unplugged for an extended period can also result in permanent Battery damage. If you are unable to charge Model X after attempting to jump start the low voltage battery, schedule a service appointment.



CAUTION: The Battery requires no owner maintenance. Do not remove the coolant filler cap and do not add fluid. If the instrument panel warns you that the fluid level is low, use the mobile app to schedule a service appointment.



CAUTION: Do not use the Battery as a stationary power source. Doing so voids the warranty.



Charging Instructions

Opening the Charge Port

The charge port is located on the left side of Model X, behind a door that is part of the rear tail light assembly. Park Model X to ensure that the charge cable easily reaches the charge port.

With Model X in Park, press and release the button on the Tesla charge cable to open the charge port door.



You can also open the charge port door using any of these methods:

- On the touchscreen, touch the Charge Port icon (lightning bolt).
- On the touchscreen, navigate to **Controls > Charging > Open Charge Port**.
- Press the charge port door when Model X is unlocked and a recognized key is nearby.
- On the key fob, hold down the rear trunk button for 1-2 seconds.
- Press the button on the charge cable to open the charge port door.
- Use voice commands to open the charge port door (see [Voice Commands on page 17](#)). You can also use voice commands to close the charge port door, and begin or stop charging.

NOTE: The following image is provided for demonstration purposes only. Depending on market region and date of manufacture, your charge port may be slightly different.

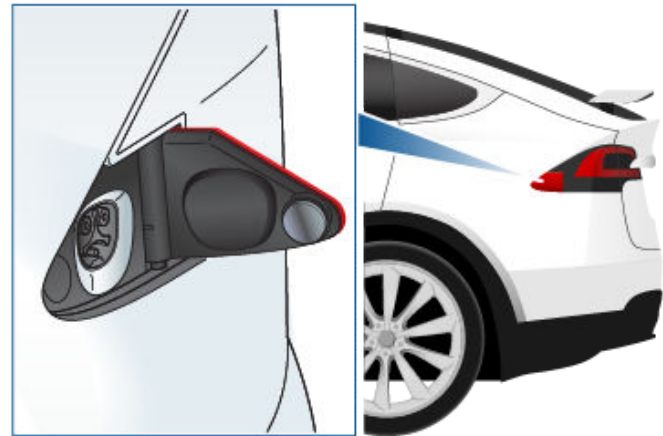

NOTE: The charge port lights up white when you open the charge port door. If you do not insert a charge cable into the charge port within a few minutes after opening the charge port door, the charge port door closes. If this happens, use the touchscreen to open the charge port door again.

NOTE: In extremely cold weather or icy conditions, it is possible that your charge port latch may freeze in place. In cases where you cannot remove or insert the charge cable, or the vehicle is not Supercharging due to the latch being frozen in place, use your Tesla mobile app to precondition your vehicle on **HI** for approximately 30-45 minutes (you must use your mobile app to precondition the vehicle; setting your climate to **HI** using the touchscreen is not effective). This can help thaw ice on the charge port latch so the charge cable can be removed or inserted.



CAUTION: Do not try to force the charge port door open.

Plugging In

If desired, use the touchscreen to change the charge limit and the charging current (see [Charge Settings on page 175](#)).

To charge at a public charging station, plug the appropriate adapter into the vehicle's charging port, and then connect the station's charging connector to the adapter. The most commonly used adapter(s) for each market region are provided. Depending on the charging equipment you are using, you may need to start and stop charging using a control on the charging equipment.

If you are using the Mobile Connector, plug into the power outlet before plugging in Model X.

Align the connector to the charge port and insert fully. When the connector is properly inserted, charging begins automatically after Model X:

- Engages a latch that holds the connector in place;
- Shifts into Park (if it was in any other drive mode);
- Heats or cools the Battery, if needed. If the Battery requires heating or cooling, you may notice a delay before charging begins.



NOTE: Whenever Model X is plugged in but not actively charging, it draws energy from the charging equipment instead of using energy stored in the Battery. For example, if you are sitting in Model X and using the touchscreen while parked and plugged in, Model X draws energy from the charging equipment instead of the Battery.

In some cases when Model X is plugged in but using very little energy, however, it may draw it directly from the Battery. For example, if you leave Model X plugged in for several days without using it, it may gradually draw a small amount of energy directly from the Battery to support vehicle systems.

Once the Battery discharges enough, it starts charging to reach the limit again. Depending on when you check, the Battery may not have discharged enough yet to trigger a charge cycle. As a result, it may be slightly under the charge limit even after being plugged in for a long period. This is normal, and Model X will start charging again once it has discharged enough. Alternatively, to start a new charge cycle manually, unplug and then plug in Model X.

CAUTION: The connector end of the charge cable can damage the paint if you drop it onto Model X.

- **WHITE (OR LIGHT BLUE):** The charge port door is open. Model X is ready to charge and the connector is not inserted, or the charge port latch is unlocked and the connector is ready to be removed.
- **BLUE:** The charger is connected, but Model X is not charging (such as when scheduled charging is active).
- **BLINKING BLUE:** Model X is communicating with the charger, but has not started charging yet (such as when your vehicle is preparing to charge).
- **BLINKING GREEN:** Charging is in progress. As Model X approaches a full charge, the frequency of the blinking slows.
- **SOLID GREEN:** Charging is complete.
- **SOLID AMBER:** The connector is not fully plugged in. Realign the connector to the charge port and insert fully.
- **BLINKING AMBER:** Model X is charging at a reduced current (AC charging only).
- **RED:** A fault is detected and charging has stopped. Check the instrument panel or touchscreen for an alert.

Charge Port Light

After you insert a charge cable into Model X, wait a few seconds and confirm that the charge port light begins blinking green and that your vehicle is charging. If the light is amber or red, troubleshoot the issue before you leave to ensure a successful charging session.

Charging Status

Charging status displays on the instrument panel when the charge port door is open.

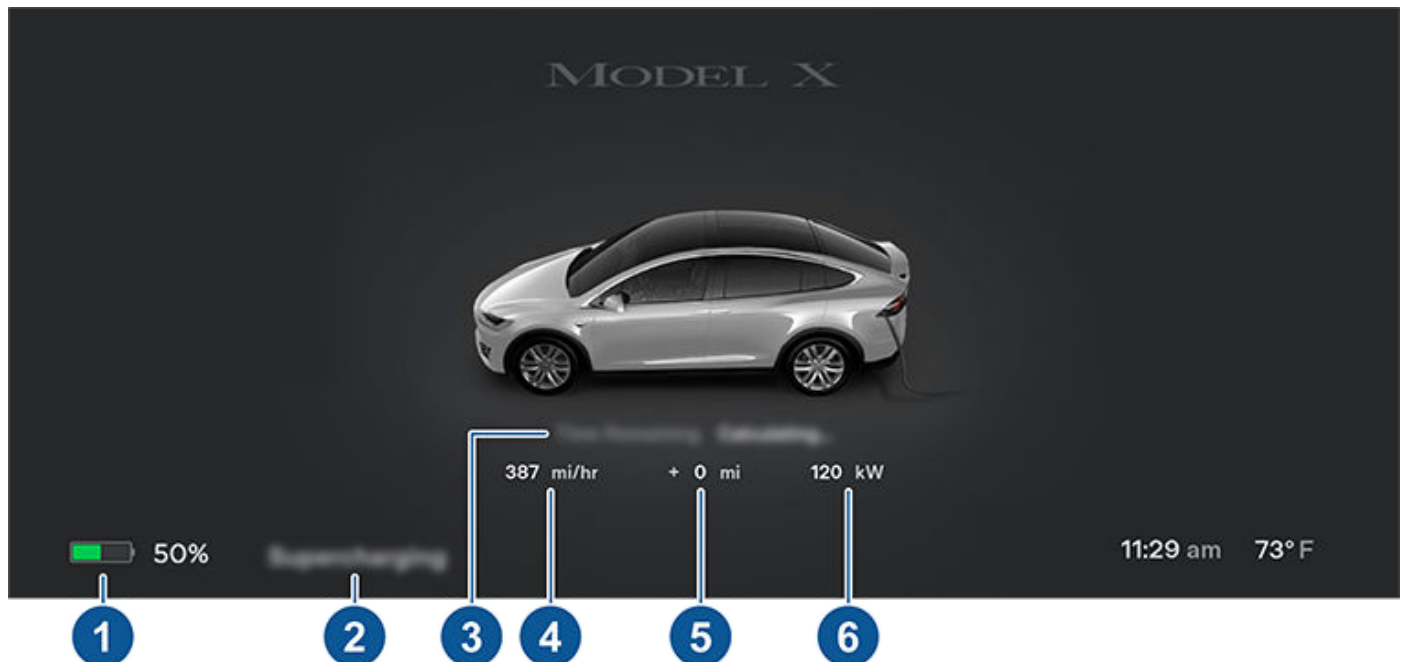



Charging Instructions

1. **Driving distance:** Displays the total estimated driving distance or energy percentage (depending on your display setting) available.

NOTE: To change how energy units are displayed, touch **Controls > Display > Energy Display**.

2. **Charge status:** Charge status messages (such as Supercharging, Scheduled Charging) display here (see [Scheduled Precondition and Charge on page 178](#)).
3. **Time remaining:** The estimated time remaining to charge to your set limit (see [Charge Settings on page 175](#)).

NOTE: When charging to 100%, the vehicle may continue to charge with low power when charging is displayed as complete. This is expected operation. Because the added energy beyond this point is low, it is usually not beneficial to continue charging.

4. **Charging rate:** The current charging speed that the vehicle is charging.
5. **Range gained:** Estimated increase in driving distance achieved in the charging session.
6. **Charging:** The current power of the charger.



If connected to a 3-phase power supply (if applicable in your region), the available current represents the current per phase and the 3-phase symbol displays.

During Charging

During charging, the charge port light pulses green, and the instrument panel displays real-time charging status. The frequency at which the green charge port light pulses slows down as the charge level approaches full. When charging is complete, the light stops pulsing and is solid green.

NOTE: If Model X is locked, the charge port light does not light up.

If the charge port light turns red while charging, a fault is detected. Check the instrument panel or touchscreen for an alert describing the fault. A fault can occur due to something as common as a power outage. If a power outage occurs, charging resumes automatically when power is restored.

NOTE: It is normal to hear sounds during charging. Particularly at high currents, the refrigerant compressor and fan operate as needed to keep the Battery cool.

NOTE: Air conditioning performance is generally not affected by charging. However, in some circumstances (for example, charging at high currents during a particularly warm day), the air coming from the vents may not be as cool as expected and a message displays on the instrument panel. This is normal and ensures that the Battery stays within an optimum temperature range while charging to support longevity and optimum performance.



WARNING: Never spray liquid at a high velocity (for example, a pressure washer) towards the charge port while charging. Doing so can result in serious injury or damage to the vehicle, charging equipment, or property.

Stopping Charging

Stop charging at any time by disconnecting the charge cable or touching **Stop Charging** on the touchscreen.

NOTE: To prevent unauthorized unplugging of the charge cable, the charge cable latch remains locked and Model X must be unlocked or able to recognize your key before you can disconnect the charge cable.

To disconnect the charge cable:

1. Press and hold the button on the connector handle to release the latch.

NOTE: You can also release the latch using the touchscreen or mobile app, or by pressing and holding the rear trunk button on the key fob. If your vehicle is equipped with a motorized charge port, you can also press the button to the left of the charge port to release the latch.

2. Pull the connector from the charge port.

If the charge cable gets frozen stuck while plugged in due to freezing temperatures, touch **Controls > Service > Charge Port Heater**. This heats the charge port for up to two hours to unfreeze the charging cable.

NOTE: You can also close the charge port door using any of these methods:

- On the touchscreen, touch the Charge Port icon (lightning bolt) on the car status overview.
- On the touchscreen, navigate to **Controls > Charging > Close Charge Port**.
- Use voice commands to close the charge port door (see [Voice Commands on page 17](#)).

To disconnect the charge cable when using an adapter at a public charge station:

1. Unlock Model X.



2. While holding the public charging handle in one hand and the adapter in the other hand, press and hold the button on the public charging handle and pull both outwards, removing the handle and adapter at the same time.

NOTE: If the charging station handle separates from the adapter, leaving the adapter in Model X, use the touchscreen to unlock the charge port.

3. Press and hold the button on the charging handle again to release the adapter from the public charging handle.

NOTE: You can also close the charge port door using any of these methods:

- On the touchscreen, touch the Charge Port icon (lightning bolt) on the car status overview.
- On the touchscreen, navigate to **Controls > Charging > Close Charge Port**.
- Use voice commands to close the charge port door (see [Voice Commands on page 17](#)).

CAUTION: Tesla strongly recommends leaving Model X plugged in when not in use. This maintains the Battery at the optimum level of charge.

Charge Settings

Access charge settings by touching **Controls > Charging** when Model X is in Park. You can also touch the charge icon on the touchscreen to access charge settings.

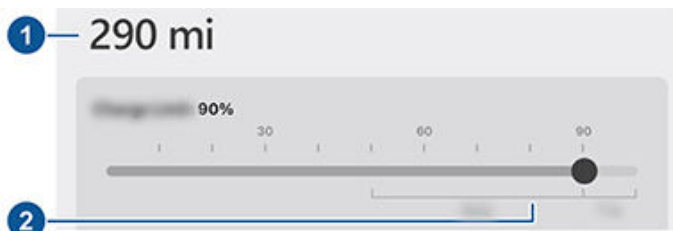

1. **Driving distance:** Displays the total estimated driving distance available.
2. **Set limit:** Adjust the charge slider to the level of charging you want. The setting you choose applies to immediate and scheduled charging sessions.

NOTE: Tesla recommends limiting the Battery's full charge level to below 90% for **Daily** use and charging to 100% only if needed for a long **Trip**.

NOTE: A portion of the battery image may appear blue. This indicates that a small portion of the energy stored in the battery is not available because the battery is cold. This is normal and no reason for concern. When the battery warms up, the blue portion no longer displays.

Slide the charge limit past the daily recommended charge limit for a pop-up option to temporarily charge above the daily recommended limit for one-time only. This is helpful for long trips and, if selected, resets back to the previous charge limit.

You can further adjust charge settings:

- **Charge current at this location:** The current automatically sets to the maximum current available from the attached charge cable, unless it was previously reduced to a lower level. If needed, touch - or + to change the current (for example, you may want to reduce the current if you are concerned about overloading a domestic wiring circuit shared by other equipment). It is not possible to set the charging current to a level that exceeds the maximum available from the attached charge cable. When you change the current, Model X remembers the location. If you charge at the same location, you do not need to change it again.

When charging using the Mobile Connector with domestic outlets, your vehicle may automatically select a default charge current. Override this default current to a higher setting by customizing **Charge Current at this location** or through the mobile app.

NOTE: For 3-phase charging, the available current represents the current per phase (up to 24A). During charging, the right status flag displays the 3-phase symbol in front of the displayed current.

NOTE: If Model X is charging and detects unexpected fluctuations in input power, the charging current is automatically reduced by 25%. For example, a 16 amp current is reduced to 12 amps. This automatic current reduction increases robustness and safety in situations when an external problem exists (for example, a home wiring system, receptacle, adapter or cord is unable to meet its rated current capacity). As a precaution, when Model X automatically reduces current, it saves the reduced current at the charging location. Although you can manually increase it, Tesla recommends charging at the lower current until the underlying problem is resolved and the charging location can provide consistent power.

- **Open Charge Port, Unlock Charge Port and Stop Charging:** When not charging, touch **Open Charge Port** or **Unlock Charge Port** to open the charge port door or to unlock the charge cable from the charge port. Use **Stop Charging** when you are finished charging.
- **Schedule:** Displays the precondition and charging schedule. You can create a precondition or charge schedule for your saved home and work locations, or your current location (see [Scheduled Precondition and Charge on page 178](#)).
- **Supercharging:** Displays Supercharger usage fees, the location, the time that charging started, and a cost estimate for the session (see [Supercharger Fees on page 176](#)).



Charging Instructions

NOTE: To reduce congestion at high-usage Supercharger sites, you may be limited to a maximum charge of 80% when not using Trip Planner (if available in your market region). See [Trip Planner on page 162](#)).

Supercharger Fees

When charging at a Tesla Supercharger, information about the charging session displays at the bottom of the charging screen. This includes the location, the time that charging started, and a cost estimate for the session. When you stop Supercharging, the estimated cost of the session displays until a new Supercharging session begins. If free charging is applicable, the estimated cost displays as zero.

NOTE: Estimated cost may not reflect the final cost of the Supercharging session. Final pricing for Supercharging sessions can be found in your Tesla account.

When charging at a Tesla supercharger, you are subject to idle fees. Idle fees are designed to encourage drivers to move their vehicle from the Supercharger when charging is complete. Idle fees are in effect only when half or more of the Superchargers at a site are occupied. The Tesla mobile app notifies you when charging is almost complete, and again when charging is complete. Additional notifications are sent if idle fees are incurred. Idle fees are waived if you move your vehicle within five minutes of when charging completed.

Log into your Tesla account to view fees and details about Supercharger sessions, track the remaining balance of free credits, set up a payment method, and make payments. Once a payment method is saved, fees are automatically paid from your account.

Manually Releasing Charge Cable

If the usual methods for releasing a charge cable from the charge port (using the charge handle release button, touchscreen, or mobile app) do not work, try pressing and holding down the rear trunk button on the key fob for 1-2 seconds. If it still doesn't release, carefully follow these steps:

1. Ensure that Model X is not actively charging by displaying the charging screen on the touchscreen. If necessary, touch **Stop Charging**.
2. Open the rear trunk.
3. Pull the charge port's release cable downwards to unlatch the charge cable.

 **WARNING:** Do not pull the release cable while simultaneously attempting to remove the charge cable from the charge port. Always pull the release cable *before* attempting to remove the charge cable. Failure to follow these instructions can result in electric shock and serious injury.



NOTE: The release cable may be recessed within the opening of the trim.

4. Pull the charge cable from the charge port.

 **CAUTION:** Use the release cable **only** in situations where you can not release the charge cable using the usual methods. Continuous use can damage the release cable or charging equipment.

 **WARNING:** Do not perform this procedure when your vehicle is charging, or if any orange high voltage conductors are exposed. Failure to follow these instructions can result in electric shock and serious injury or damage to the vehicle. If you are uncertain as to how to safely perform this procedure, contact your nearest Service Center.

Charging Best Practices

- Avoid allowing the Battery to get too low (the Battery icon turns yellow when the capacity remaining in the Battery drops to 20% or below).
- Refer to the information on the vehicle touchscreen (navigate to **Controls > Charging**) or the mobile App (touch the **Charging** icon) for recommended daily and trip charging limits.
- After you plug in your vehicle, confirm that the charge port light begins blinking green (indicating that Model X is charging) before you walk away. If Model X does not begin charging after a few seconds, the connector may not be fully inserted into the charge port, or there may be an issue preventing charging. Check the touchscreen for an alert with more information.



NOTE: If the charge port light begins blinking amber, Model X is charging at a reduced current. If the charge port light is solid blue, the charger is connected but the vehicle is not charging (such as when a charge is scheduled). For more information, see [Charge Port Light on page 173](#).

Fast charging tips:

- Find fast chargers by filtering for three lightning bolts in the navigation search bar.
- Navigate to fast chargers to allow for preconditioning of the high voltage Battery. An optimal Battery temperature can help speed up charging.
- Typically, a lower state of charge results in faster charging.

NOTE: It is your responsibility to monitor your vehicle's charge at all times. Do not wait until the vehicle is discharged to plug it in. Always ensure you have more than enough charge to safely get to a charger.

- At Superchargers, leave some space between other vehicles, as neighboring stalls may share power.



Scheduled Precondition and Charge

Schedule preconditioning and charging for Model X. You can schedule preconditioning to help your vehicle charge more efficiently, or to prepare Model X for departure.

NOTE: You can also access **Schedule** from the Climate Controls screen, the Charging window, and the Tesla mobile app (v4.34.5 or higher required).

Model X automatically saves your schedule for each location you create a schedule at. When you select **Current Location**, the configured schedule can only be used when you return to the same approximate physical location.

NOTE: Scheduled charge cannot be used with fast chargers, including Tesla Superchargers. Charging schedules you create are ignored when you charge at a fast charger.

Create a Schedule

Create a **Precondition** and **Charge** schedule to specify the time and days you want Model X to precondition or charge. To create a schedule:

1. Touch **Controls** > **Schedule**.
2. Select the location for which you want to configure a schedule.
 - **Current Location:** The current location of your car, based on your GPS coordinates.

NOTE: You must be parked to create a schedule for your current location.
 - **Home/Work:** The saved location for your home and workplace. You can't choose these options if you don't have a saved home or work (see [Home, Work, and Favorite Destinations on page 160](#)).
3. Touch **Precondition** to configure the time and the frequency you want the vehicle to precondition by.
4. Touch **Charge** to configure the time you want to start and stop, and the frequency you want to charge.
5. Select **Create** to create the schedule.

NOTE: If **Repeat Weekly** is not toggled, Model X performs the schedule once. The vehicle then disables the schedule until you manually re-enable the schedule.

Using Scheduled Charging

When you create or enable a scheduled charge, you can plug in your vehicle for a charge. If you scheduled a precondition or charge for later in the day, Model X waits until that time to precondition or charge.

When your schedules overlap, the vehicle uses the largest block of time for charging, if necessary. Example: You scheduled Model X to start charging at 2 AM and at 3 AM, but to stop charging at 2:30 AM and 5 AM, the vehicle combines the two charge schedules into a single block from 2 AM to 5 AM.

When you specify an **End by** time, but not a **Start at** time, the vehicle briefly draws power when plugging in for scheduled charging (you may hear clicking) to calculate the necessary start time to meet your charge limit. Example: You configure an **End by** time of 2 AM and the vehicle needs 2 hours to charge to meet the charge limit. If you plug in your vehicle at 9 PM, Model X briefly draws power to calculate the start time and begins charging at 12 AM.

If you specify a **Start at** time and no **End by** time, the vehicle begins charging at the specified time and continues until your charge limit is reached.

There are scenarios where **Scheduled Charging** starts immediately. These scenarios can occur when Model X is plugged in:

- During a scheduled charge.
- Up to 6 hours after the start of a scheduled charge, if there is no specified **End by** time.
- When the next scheduled charge is more than 18 hours away and not the current day.
- When you haven't configured a **Start at** time and there is not enough time to reach the charge limit by the **End by** time.

NOTE: Model X does NOT automatically start charging if you plug in your vehicle within 6 hours after the **End by** time of a scheduled charge, unless there is another scheduled charge.

You can schedule your charge to finish right at a planned departure time to reduce energy costs, even in market regions where off-peak utility rates are not applicable. Example, if charging starts as soon as you plug in, charging may complete much sooner. This causes the Battery to cool down to ambient temperatures and requires energy to warm it back up by your departure time. Therefore, even if off-peak utility rates are not applicable to you, Tesla recommends that you charge until your planned departure time in order to reduce energy consumption by specifying your departure time as the scheduled **End by** time.

Preconditioning

Use **Precondition** to schedule a time when you want Model X to be ready to drive. Model X automatically calculates when it needs to start preconditioning. This ensures that the cabin climate and Battery are preconditioned by your departure time.

Precondition warms the Battery for improved performance and ensures a comfortable cabin climate at your set departure time. If you don't schedule a **Precondition**, Model X only warms the Battery before charging if the Battery is too cold to charge, and doesn't prepare the cabin climate.

NOTE: When Model X is not plugged in, preconditioning operates but only when the Battery's charge level is above 20%.



Preconditioning can also help to increase range on your next trip because a preconditioned cabin and battery consumes less energy when you begin driving. Preconditioning can reduce energy consumption while driving in vehicles with heat pumps, because heat in the battery can be used to warm the cabin while driving.



Getting Maximum Range

Factors Affecting Energy Consumption

While driving:

- Elevated driving speed.
- Environmental conditions such as cold or hot weather and wind.
- Using climate controls to heat or cool the cabin.
- Uphill travel: Driving uphill requires more energy and depletes range at a faster rate. However, driving downhill allows your vehicle to regain a portion of its expended energy through regenerative braking (see [Regenerative Braking on page 87](#)).
- Short trips or stop-and-go traffic: It takes energy to bring the cabin and Battery to a specified temperature when starting the vehicle. You may see a higher average consumption when the vehicle is used for very short trips or in heavy traffic.
- Heavy cargo load.
- Windows rolled down.
- Wheels and tires not maintained.
- Customized settings or third-party accessories (roof or trunk racks, third party wheels).

While parked and not plugged in to a charger:

- Preconditioning the cabin or using climate controls.
- Vehicle infotainment and climate controls system.
- Sentry mode.
- Tesla or third-party mobile app requests.

Tips to Maximize Range

You can maximize your driving range using the same driving habits you use to conserve fuel in a gasoline-powered vehicle. To achieve maximum range:

- Slow down your driving and avoid frequent and rapid acceleration. Consider using Chill Mode (touch **Controls > Pedals & Steering > Acceleration**) and Speed Assist (see [Speed Assist on page 141](#)) to assist in controlling your acceleration and speed.
- If safe to do so, modulate the accelerator pedal instead of using the brake pedal when gradually slowing down. Whenever Model X is moving and you are not pressing the accelerator pedal, regenerative braking slows down the vehicle and feeds surplus energy back to the Battery (see [Regenerative Braking on page 87](#)).
- Limit the use of resources such as heating and air conditioning. Using seat and steering wheel heaters (if equipped) to keep warm is more efficient than heating the cabin using climate controls.

- With your vehicle plugged in, use the mobile app to precondition your vehicle to ensure the cabin is at a comfortable temperature and windows are defrosted (if needed) before your drive by touching **Climate > On** and customizing your preferences (see [Mobile App on page 66](#)).
- Touch **Schedule**, (also available on both the charging and climate control screens) to set a time when you want your vehicle to be ready to drive (see [Scheduled Precondition and Charge on page 178](#)).
- Set Stopping Mode to **Hold** to gain the benefit of regenerative braking at low driving speeds.
- Ensure the wheels are aligned to specification, the tires are kept at the recommended inflation pressures (see [Tire Care and Maintenance on page 185](#)), and are rotated when needed (see [Maintenance Service Intervals on page 183](#)).
- Lighten your load by removing any unnecessary cargo.
- Fully raise all windows.
- Turn on Range Mode, if equipped (see [Range Mode on page 181](#)).
- Features such as Sentry Mode and Cabin Overheat Protection can impact range. Disable features when not needed.
- To prevent an excessive amount of energy consumption while the vehicle is idle, keep the vehicle plugged in when not in use.

It is normal for estimated range to decrease slightly over the first few months before leveling off. Over time, you may see a gradual, but natural, decrease in range at full charge – this depends on factors such as the mileage and age of the Battery. Your Model X will inform you in the unlikely event a hardware issue is causing excessive Battery or range degradation.

The power meter on the instrument panel provides feedback on energy usage.

Range Assurance

The driving range displayed in Model X is an estimate of the remaining battery energy based on EPA-rated consumption. It may not account for your personal driving patterns or external conditions. The displayed range on the instrument panel may decrease faster than the actual distance driven. To view estimated range based on your recent energy consumption, open the Energy app to display the graph.

NOTE: Rated driving range is based on EPA-rated consumption in the United States, which deviates from tests advertised and performed in other jurisdictions.

Your vehicle continuously monitors its energy level and proximity to known charging locations.



Touch **Chargers** in the Navigation search bar to toggle between types of chargers, including Superchargers and destination charging sites.

When you are at risk of driving beyond the range of known charging locations, the touchscreen displays a message giving you the opportunity to display a list of charging locations that are within range. When you select a charging location from the list, Model X provides navigation instructions and the turn-by-turn direction list displays the predicted amount of energy that will remain when you arrive at the charging destination.

Trip Planner (if available in your market region) routes you through Supercharger locations to minimize the amount of time you spend charging and driving. To enable, touch **Controls > Navigation > Trip Planner**.

Energy App

The Energy app provides a visual representation of your vehicle's real-time and projected energy usage. To use the Energy app, navigate to **Application Launcher > Energy** on the touchscreen. Choose from two types of charts:

- **Consumption:** Display how much energy Model X has consumed over the past 10, 25 or 50 km.

Touch **Instant Range** or **Average Range** to adjust the projected range estimation. Instant Range uses only the latest few data points to estimate the projected range, whereas Average Range uses the past 10, 25 or 50 km of energy consumption to provide a more accurate projected range.

- **Trip:** You can monitor the amount of energy being used while navigating to a destination. You can track actual usage against the initial prediction. The green line represents the actual usage whereas the gray line represents predicted usage. To change the zoom level, touch the zoom icon located in the top right corner of the chart.

NOTE: The Trip chart displays energy usage only if you are currently navigating to a destination.

Range Mode

Range Mode (if equipped) conserves energy by limiting the power of the climate control system and turns off the signature lights. Turn Range Mode on by touching **Controls > Driving > Range Mode**. When turned on in an All-Wheel Drive vehicle, Range Mode also optimizes torque distribution between the motors to maximize range.

Saving Energy

Model X has an energy-saving feature that reduces the amount of energy being consumed when Model X is not in use. On newer vehicles, this feature is automated to provide an optimal level of energy saving. However, on older vehicles, you can touch **Controls > Display > Energy Saving** and choose from the following options:

- **OFF** - Model X automatically shifts to the energy-saving mode only at night (10 pm to 5 am). Idle energy consumption may increase.
- **ON** - Significantly less energy is consumed whenever Model X is not in use. The start-up time of the instrument panel and Bluetooth could be slower.
- **Always Connected** - Preserves cellular connectivity when energy saving is active. This allows the mobile app to connect to Model X quicker, and provides immediate internet access when entering the car. Slightly more energy is consumed.



Loading New Software

Tesla updates your vehicle's software over the air, constantly providing new features. Tesla recommends you install software updates at the earliest opportunity on your vehicle. To ensure the fastest and most reliable delivery of software updates, leave Wi-Fi turned on and connected whenever possible. In most cases, your vehicle must be connected to Wi-Fi to download the software update (see [Wi-Fi on page 68](#)).

Downloading vs. Installing New Software

There are two steps to receiving a new update: downloading the software (which requires Wi-Fi), and installing it. For your convenience, you can start downloads and installations using the Tesla mobile app.

Download

When a software update is available for download, the download occurs automatically, showing a green arrow at the top of the touchscreen. If the vehicle is not connected to Wi-Fi, a yellow download icon appears. Although you can drive while the software update is being downloaded, doing so can interrupt the download if your vehicle loses the Wi-Fi connection. When the software update is fully downloaded and ready to install, a clock icon displays at the top of the touchscreen.

NOTE: To ensure the fastest and most reliable download of software updates, leave the Wi-Fi turned on and connected whenever possible (see [Wi-Fi on page 68](#)).

Install

You CANNOT drive while software is being installed. If plugged in, your vehicle will stop charging until the installation is complete. To start the installation, touch the yellow clock icon at the top of the touchscreen. Touch **Install Now** to begin the installation immediately or touch **Set For This Time** to choose a different start time. At any time before the update installs, you can touch this clock icon to reschedule. If you are driving Model X at the scheduled update time, the update is canceled and must be rescheduled. You can also view, download, and install software updates by navigating to **Controls > Software**. If available, connect to Wi-Fi to download the update.

Software updates are not performed when certain features are active, such as Keep Climate On, Dog Mode, or Camp Mode and Smart Preconditioning.

NOTE: Software updates will not install if Keep, Dog, or Camp mode are enabled (see [Keep Climate On, Dog, and Camp on page 152](#)).

NOTE: On an as-needed basis, Tesla also sends software updates using a cellular connection.

NOTE: Some software updates take approximately 30 minutes to complete (some may take longer). Model X must be in Park while the software is being updated.



WARNING: Do not attempt to use the vehicle while the software is being installed. Vehicle functions, including some safety systems and opening or closing the doors or windows, may be limited or disabled when installation is in progress and you could damage the vehicle.

Software Update Preferences

Tesla determines how, when, and where to send updates to vehicles based on various factors unique to each release. In **Controls > Software**, you can choose how quickly you want to receive updates that are ready for your vehicle. Be an early adopter by selecting **Advanced** (which will have additional releases), or wait until others have installed (which will result in fewer releases) by selecting **Standard**. Choosing **Advanced** does not enroll your vehicle in Tesla's early access program.

Tesla does not update your software upon request for those wanting to receive the latest features and improvements. Selecting **Advanced** and consistently connecting to Wi-Fi (see [Wi-Fi on page 68](#)) is the best way to quickly receive the latest software updates.

If the touchscreen displays a message indicating that a software update was not successfully completed, wait for the next software update to deploy to your vehicle.

NOTE: The software update screen persists until you install the update. Install a software update as soon as possible. Any harm resulting from failure to install a software update is not covered by the vehicle's warranty. Failure or refusal to install updates can cause some vehicle features to become inaccessible or digital media devices may become incompatible.

NOTE: Tesla may update or reinstall your vehicle's software as part of the normal diagnostic, repair, and maintenance process within Tesla Service.

NOTE: Reverting to a previous software version is not possible.

Charging

If Model X is charging when the software update begins, charging stops. Charging resumes automatically when the software update is complete.

Viewing Release Notes

When a software update is complete, read the release notes displayed on the touchscreen to learn about changes or new features. To display release notes about the current version of your vehicle's software at any time, touch **Controls > Software > Release Notes**.

Tesla strongly recommends reading all release notes. They may contain important safety information or operating instructions for your Model X.



Service Intervals

Tesla recommends the following maintenance items and intervals, as applicable to your vehicle, to ensure continued reliability and efficiency of your Model X.

For additional information on vehicle alerts, see [Troubleshooting Alerts on page 221](#).

- Brake fluid health check every 4 years (replace if necessary)*.
- A/C desiccant bag replacement every 4 years.
- Cabin air filter replacement every 2 years.
- HEPA filters and carbon filters replacement every 3 years.
- Clean and lubricate brake calipers every year or 12,500 miles (20,000 km) if in an area where roads are salted during winter.
- Rotate tires every 10,000 km or if tread depth difference is 1.5 mm or greater, whichever comes first.

*Heavy brake usage due to towing, mountain descents, or performance driving -- especially for vehicles in hot and humid environments -- may necessitate more frequent brake fluid checks and replacements.

NOTE: Any damage caused by opening the Battery coolant reservoir is excluded from the warranty.

NOTE: The above intervals are based on typical driving behaviors and scenarios. Depending on various circumstances such as driving behavior, usage, environmental conditions, etc., the above maintenance items may need to be performed more or less frequently than specified. Additionally, the above list should not be considered comprehensive and does not include consumable parts such as windshield wipers, brake pads, low voltage battery, etc.

NOTE: Damages or failures caused by maintenance or repairs performed by non-Tesla certified technicians are not covered by the warranty.

For more do-it-yourself maintenance procedures and information, see <https://www.tesla.com/support/do-it-yourself-guides>.

Schedule Service

Scheduling a service visit through the mobile app is easy. After touching **Service**, select the type of service needed and follow the directions in the mobile app. Provide as much detail as possible to better help the Service team identify the cause of concern, such as:

- Photos, sound recordings, or videos.
- Date(s), time(s), and time zone when the issue occurred.
- Country of use and location.
- Approximate speed the vehicle was traveling (if applicable).

- Environmental conditions (rain, snow, cold, etc.).
- Road name and type of road (if applicable).
- Quality of lane markings (if applicable).
- Applicable vehicle settings.
- Identifiable symptoms.

Visit <https://www.tesla.com/support/service-visits> for more information on scheduling service.

Daily Checks

- Check the Battery's charge level, displayed on the instrument panel or mobile app.
- Check the condition and pressure of each tire (see [Tire Care and Maintenance on page 185](#)).
- Check that all exterior lights, horn, turn signals, and wipers and washers are working.
- Check for any unexpected indicator lights or vehicle alerts on the touchscreen or instrument panel.
- Check the operation of the brakes, including the parking brake.

NOTE: Because Model X uses regenerative braking (see [Regenerative Braking on page 87](#)), the brake pads are typically used less frequently than those in traditional braking systems. To avoid the accumulation of rust and corrosion, Tesla recommends frequently pressing the brake pedal to apply the mechanical brakes, which dries the brake pads and rotors.

- Check the operation of the seat belts (see [Seat Belts on page 41](#)).
- Look for abnormal fluid deposits underneath Model X that might indicate a leak. It is normal for a small pool of water to form (caused by the air conditioning system's dehumidifying process).
- Look around the exterior of Model X and immediately remove any corrosive substances (such as bird droppings, tree resin, tar spots, dead insects, industrial fallout, etc.) to prevent damage to the exterior (see [Cleaning on page 191](#)).

Monthly Checks

- Check windshield washer fluid level and top up if necessary (see [Topping Up Windshield Washer Fluid on page 195](#)).
- Check that the air conditioning system is operating correctly (see [Operating Climate Controls on page 149](#)).



Maintenance Service Intervals

NOTE: In addition to cooling the interior, the air conditioning compressor also cools the Battery. Therefore, in hot weather, the air conditioning compressor can turn on even if you turned it off. This is normal because the system's priority is to cool the Battery to ensure it stays within an optimum temperature range to support longevity and optimum performance. Also, even when not in use, you may hear Model X emit a whining noise or the sound of water circulating. These sounds are normal and occur when the internal cooling systems turn on to support various vehicle functions, such as maintaining the low voltage battery and balancing the temperature of the high voltage Battery.

Periodic Checks

Perform the following checks as needed:

- Over time, when driving in dusty or polluted conditions, your vehicle's radiator may become clogged. This can affect air flow and heating/AC performance. Use the mobile app to schedule a service appointment.
- The inside of the windshield within the camera enclosure (see [Cameras on page 19](#)) must be cleaned periodically to maintain clear visibility and optimal camera function. To check if such cleaning is needed, review your vehicle's maintenance summary by touching **Controls > Service > Maintenance**. When needed, use the mobile app to schedule a service appointment.

Maintenance Summary

You can view current status of maintenance items by navigating to **Controls > Service > Maintenance** on your vehicle's touchscreen.

Maintenance Summary keeps track of when regular maintenance items, such as windshield wiper blades and filters, were last performed and provides suggestions for when they should be performed again. You can [perform them yourself](#) or enlist the help of Tesla or an independent repairer. Once completed, you can reset the maintenance item on your vehicle's touchscreen. Model X captures a time stamp and applicable information (such as your current mileage) and resets the maintenance item to remind you for next time. Vehicle service history records persist on the vehicle, providing you and future owners with a record of previously performed services. The service history record is not affected by a factory reset.

NOTE: Although Tesla updates the maintenance summary during a service visit as needed, it is the responsibility of the vehicle's owner to ensure the accuracy of the information, especially for service or maintenance performed by independent repairers or through do-it-yourself means.

Fluid Replacement Intervals

Battery coolant and brake fluid levels should only be checked by Tesla or a professional automotive repair shop. Specific service information is available in the Service Manual.

- **Battery coolant:** Your Battery coolant does not need to be replaced for the life of your vehicle under most circumstances.

NOTE: Any damage caused by opening the Battery coolant reservoir is excluded from the warranty.

- **Brake fluid:** Do not top up your brake fluid.

Software

Updating software is important to ensure proper operation and longevity of your vehicle's components. You must install a software update at the earliest opportunity. See [Software Updates on page 182](#).

Tesla may update or reinstall your vehicle's software as part of the normal diagnostic, repair, and maintenance process within Service.

High Voltage Safety

Your Model X has been designed and built with safety as a priority. However, be aware of these precautions to protect yourself from the risk of injury inherent in all high-voltage systems:

- Read and follow all instructions provided on the labels that are attached to Model X. These labels are there for your safety.
- The high voltage system has no user-serviceable parts. Do not disassemble, remove or replace high voltage components, cables or connectors. High voltage cables are colored orange for easy identification.
- If a collision occurs, do not touch any high voltage wiring, connectors, or components connected to the wiring.
- In the unlikely event that a fire occurs, immediately contact your local fire emergency responders.

 **WARNING:** Always disconnect the charge cable before working underneath Model X, even if charging is not in progress.

 **WARNING:** Keep your hands and clothing away from cooling fans. Some fans operate even when Model X is powered off.

 **WARNING:** Some fluids (Battery acid, Battery coolant, brake fluid, windshield washer additives, etc.) used in vehicles are poisonous and should not be inhaled, swallowed, or brought into contact with open wounds. For your safety, always read and follow instructions printed on fluid containers.



Displaying Tire Pressures

You can display tire pressures on the instrument panel by using the right or left steering wheel buttons to display **Car Status** (see [Using Left Steering Wheel Buttons on page 77](#) or [Using Right Steering Wheel Buttons on page 78](#)). The pressure of each tire displays in the visualization of your vehicle, in addition to what time the tire pressures were last measured. To choose whether you want to display tire pressures using Bar or PSI, touch **Controls > Display > Tire Pressure**.

You can also view tire pressures in the Tesla mobile app.

NOTE: You may need to drive briefly before the visualization displays the tire pressure values.

Maintaining Tire Pressures

Keep tires inflated to the pressures shown on the Tire Information label, even if it differs from the pressure printed on the tire itself. The Tire and Loading Information label is located on the center door pillar and is visible when the driver door is open.

If you are towing a trailer, do not use the tire pressures printed on the Tire and Loading Information Label. Instead, refer to the tire pressures published in the towing section (see [Towing and Accessories on page 104](#)).



The Tire Pressure indicator light on the instrument panel alerts you if one or more tires is under- or over-inflated.

The Tire Pressure indicator light does not immediately turn off when you adjust tire pressure. After inflating the tire to the recommended pressure, you must drive over 25 km/h for a short amount of time to activate the Tire Pressure Monitoring System (TPMS), which turns off the Tire Pressure indicator light.

If the indicator light flashes for one minute whenever you power on Model X, a fault with the TPMS is detected (see [TPMS Malfunction on page 188](#)).

NOTE: Your vehicle's tire pressures will drop in cold ambient temperatures. If the TPMS indicator light appears, inflate the tires before driving. The tires will lose one PSI for every 6° C drop in outside temperature. Proper tire pressures help protect tires from potholes and improve range when properly inflated.



WARNING: Under-inflation is the most common cause of tire failures and can cause a tire to overheat, resulting in severe tire cracking, tread separation, or blowout, resulting in unexpected loss of vehicle control and increased risk of injury. Under-inflation also reduces the vehicle's range and tire tread life.



WARNING: The Low Tire Pressure indicator light alerts you only in situations when a tire is below the recommended threshold (as indicated on the Tire and Loading Information label) under normal driving conditions. It does not alert you when a tire is under-inflated based on the load you are carrying.



WARNING: Check tire pressures using an accurate pressure gauge when tires are cold. It takes only about 1.6 kms of driving to warm up the tires sufficiently to affect tire pressures. Parking the vehicle in direct sunlight or in hot weather can also affect tire pressures. If you must check warm tires, expect increased pressures. Do not let air out of warm tires in an attempt to match recommended cold tire pressures. A hot tire at or below the recommended cold tire inflation pressure is dangerously under-inflated.

Checking and Adjusting Tire Pressures

Follow these steps when tires are cold and Model X has been stationary for over three hours:

1. Refer to the Tire Information label located on the driver's center door pillar for the target tire pressure.
2. Remove the valve cap.
3. Firmly press an accurate tire pressure gauge onto the valve to measure pressure.
4. If required, add or remove air to reach the recommended pressure.

NOTE: You can release air by pressing the metal stem in the center of the valve.

5. Re-check pressure using the accurate tire gauge.
6. Repeat steps 3 and 4 as necessary until the tire pressure is correct.
7. Reinstall the valve cap to prevent dirt from entering. Periodically check the valve for damage and leaks.

Inspecting and Maintaining Tires

Regularly inspect the tread and side walls for any sign of distortion (bulges), foreign objects, cuts or wear.



Tire Care and Maintenance

⚠ WARNING: Do not drive Model X if a tire is damaged, excessively worn, or inflated to an incorrect pressure. Check tires regularly for wear, and ensure there are no cuts, bulges or exposure of the ply/cord structure. In addition, pay attention for wear on the tire's inner shoulder.

Tire Wear

Adequate tread depth is important for proper tire performance. Tires with a tread depth less than 3 mm are more likely to hydroplane in wet conditions and should not be used. Tires with a tread depth less than 4 mm do not perform well in snow and slush and should not be used when driving in winter conditions.

Model X is originally fitted with tires that have wear indicators molded into the tread pattern. When the tread has been worn down to 2 mm, the indicators start to appear at the surface of the tread pattern, producing the effect of a continuous band of rubber across the width of the tire. For optimal performance and safety, Tesla recommends replacing tires before the wear indicators are visible.

To improve vehicle handling characteristics and minimize hydroplaning in wet conditions, put tires with the most tread on the rear of the car.

Tire Rotation, Balance, and Wheel Alignment

Tesla recommends rotating the tires every 10,000 km or if tread depth difference is 1.5 mm or greater, whichever comes first.

Tire rotation is an essential part of tire maintenance. It helps maintain an even treadwear pattern which enhances the tire's overall wear quality, decreases road noise and maximizes tire life.

Vehicles with staggered wheels and non-directional tires can be rotated side-to-side (left-to-right) but not front-to-back as the front and rear tire size is different. Left-to-right rotation can increase tread life by changing the direction of rotation for each tire and balancing shoulder wear.

Unbalanced wheels (sometimes noticeable as vibration through the steering wheel) affect vehicle handling and tire life. Even with regular use, wheels can get out of balance. Therefore, they should be balanced as required.

If tire wear is uneven (on one side of the tire only) or becomes abnormally excessive, check the wheel alignment.

Punctured Tires

A puncture eventually causes the tire to lose pressure, which is why it is important to check tire pressures frequently. Permanently repair or replace punctured or damaged tires as soon as possible.

Your tubeless tires may not leak when penetrated, provided the object remains in the tire. If, however, you feel a sudden vibration or ride disturbance while driving, or you suspect a tire is damaged, immediately reduce your speed. Drive slowly, while avoiding heavy braking or sharp steering and, when safe to do so, stop the vehicle. Arrange to have Model X transported to a Tesla Service Center, or to a nearby tire repair center.

NOTE: In some cases, you can temporarily repair small tire punctures (under 6 mm) using an optional tire repair kit available from Tesla. This allows you to slowly drive Model X to Tesla or to a nearby tire repair facility.

⚠ WARNING: Do not drive with a punctured tire that has not been repaired, even if the puncture has not caused the tire to deflate. A punctured tire can deflate suddenly at any time.

Flat Spots

If Model X is stationary for a long period, tires can form flat spots. When Model X is driven, these flat spots cause a vibration which gradually disappears as the tires warm up and regain their original shape.

Improving Tire Mileage

To improve the mileage you get from your tires, maintain tires at the recommended tire pressures, observe speed limits and advisory speeds, and avoid:

- Pulling away quickly, or hard acceleration.
- Fast turns and heavy braking.
- Potholes and objects in the road.
- Hitting curbs when parking.
- Contaminating tires with fluids that can cause damage.

Replacing Tires and Wheels

Tires degrade over time due to the effects of ultraviolet light, extreme temperatures, high loads, and environmental conditions. It is recommended that tires are replaced every six years, or sooner if required, even if tread depth is above the minimum.

If tires need to be replaced early, for example due to a flat tire, we recommend replacing the tires in pairs unless the other tires are within 1.5 mm of tread depth of the new tire. When replacing tires, it is important to match the brand and model of the older tires. Always place a pair of new tires on the rear if all four tires are the same size. Always balance the wheel and tire after replacing a tire. Consult with a professional tire retailer and installer for further guidance. It may take up to 24 hours after a tire replacement or repair before the tire lubricant is completely dry and tires achieve maximum adherence to the rims. Avoid hard accelerations during this period to avoid tire slip on the rim.



NOTE: Regardless of the number of tires replaced, a complete set of matching tires is recommended for optimum performance.

If tires other than those specified are used, ensure that the load and speed ratings marked on the tire (see [Understanding Tire Markings on page 210](#)) equal or exceed those of the original specification.

For the specification of the original wheels and tires installed on Model X, see [Wheels and Tires on page 209](#).

If you replace a wheel, the TPMS (Tire Pressure Monitoring System) sensors need to be reset to ensure they provide accurate warnings when tires are under- or over-inflated (see [Automatic Reset of TPMS Sensors on page 189](#)).

WARNING: For your safety, use only tires and wheels that match the original specification. Tires that do not match the original specification can affect the operation of the TPMS.

WARNING: Never exceed the speed rating of your vehicle's tires. The speed rating is shown on the sidewall of your tires (see [Understanding Tire Markings on page 210](#)).

Asymmetric Tires

Some Model X tires are asymmetric and must be mounted on the wheel with the correct sidewall facing outward. The sidewall of the tire is marked with the word **OUTSIDE**. When new tires are installed, make sure that the tires are correctly mounted on the wheels.



WARNING: Road holding is seriously impaired if the tires are incorrectly installed on the wheels.

Removing and Installing Aero Covers

If your Model X is equipped with aero covers, you must remove them to access the lug nuts.

To remove an aero cover:

1. Grasp the aero cover firmly with both hands.
2. Pull the aero cover toward you to release the retaining clips.

To install an aero cover:

1. Align the aero cover with the valve stem.

2. Firmly press the center of the cover to secure it in place, then work your way out to firmly pressing the outer perimeter of each spoke. You may need to hold onto the opposite side of the cover until all spokes are secured.
3. Firmly press the center of the cap with your hands (do not hit the cover with your hands) to ensure it is secured.
4. As a final check, quickly pull each spoke to confirm they are secured in place.

CAUTION: To prevent the aero cover from falling off, ensure that it is fully secured before driving.

Removing and Installing Lug Nut Covers

If your Model X is equipped with lug nut covers, you must remove them to access the lug nuts.

To remove a lug nut cover:

1. Insert the curved part of the lug nut cover tool, if equipped (located in the glovebox in some vehicles, or you can use a small allen wrench) into the hole at the base of the Tesla "T".

NOTE: The lug nut cover tool can also be purchased at an auto parts store or through online retailers.



2. Maneuver the lug nut cover tool so that it is fully inserted into the hole in the lug nut cover.
3. Twist the lug nut cover tool so that the curved part is touching the middle of the lug nut cover.
4. Firmly pull the lug nut tool away from the wheel until the lug nut cover is released.



To install the lug nut cover:

1. Align the lug nut cover into position.
2. Push firmly on the lug nut cover until it fully snaps into place.

 **CAUTION:** Make sure the lug nut cover is fully secure before driving to prevent it from falling off.

Wheel Configuration

If you are installing new wheels or swapping them for different ones, update your vehicle's wheel configuration by touching **Controls > Service > Wheel & Tire > Wheels**. This allows Model X to learn the new wheels and provide more accurate status updates on your vehicle. Select a wheel from the drop down menu that matches the new wheels you plan to install on Model X. Selecting new wheels in the wheel configuration also changes the wheels that appear on your vehicle's avatar on the touchscreen.

Ensure you are aware if your vehicle is equipped with staggered wheels, meaning the wheels are different sizes in the front and rear. Check the front and rear tire sizes marked on the tire sidewall to see if they match or are different sizes. If the wheels are staggered, take extra precaution to ensure the new wheels you install are staggered in the same way as the previous wheels.

NOTE: Changing your vehicle's wheel configuration can impact range estimates, tire pressure warning levels, and vehicle visualization.

 **WARNING:** Only use Tesla-approved wheels when installing or swapping wheels. Using non Tesla-approved wheels can cause serious damage. Tesla is not liable for damage caused by using wheels not approved by Tesla.

Tire Pressure Monitoring



The Model X is equipped with a tire pressure monitoring system that warns the driver of significant under-inflation or over-inflation of the tires by displaying the Tire Pressure Indicator Light. Check the Tire Information label located on the driver's door pillar for more details, or see [Maintaining Tire Pressures](#) on page 185.

Each tire, including the spare (if provided), should be checked monthly when cold and inflated to the inflation pressure recommended by the vehicle manufacturer on the vehicle placard or tire inflation pressure label. (If your vehicle has tires of a different size than the size indicated on the vehicle placard or tire inflation pressure label, you should determine the proper tire inflation pressure for those tires.)

As an added safety feature, your vehicle has been equipped with a tire pressure monitoring system (TPMS) that illuminates a low tire pressure telltale when one or more of your tires is significantly under-inflated. Accordingly, when the low tire pressure telltale illuminates, you should stop and check your tires as soon as possible, and inflate them to the proper pressure. Driving on a significantly under-inflated tire causes the tire to overheat and can lead to tire failure. Under-inflation also reduces fuel efficiency and tire tread life, and may affect the vehicle's handling and stopping ability.

Please note that the TPMS is not a substitute for proper tire maintenance, and it is the driver's responsibility to maintain correct tire pressure, even if under-inflation has not reached the level to trigger illumination of the TPMS low tire pressure telltale.

TPMS Malfunction

Your vehicle has also been equipped with a TPMS malfunction indicator to indicate when the system is not operating properly. The TPMS malfunction indicator is combined with the low tire pressure telltale. When the system detects a malfunction, the telltale will flash for approximately one minute and then remain continuously illuminated. This sequence will continue upon subsequent vehicle start-ups as long as the malfunction exists.

When the malfunction indicator is illuminated, the system may not be able to detect or signal low tire pressure as intended. TPMS malfunctions may occur for a variety of reasons, including the installation of replacement or alternate tires or wheels on the vehicle that prevent the TPMS from functioning properly. Always check the TPMS malfunction telltale after replacing one or more tires or wheels on your vehicle to ensure that the replacement or alternate tires and wheels allow the TPMS to continue to function properly.



The TPMS malfunction indicator is combined with the tire pressure indicator light. If Model X detects a fault with the TPMS, this indicator flashes for one minute whenever you power on Model X.

NOTE: If a tire has been replaced or repaired using a different tire sealant than the one available from Tesla, and a low tire pressure is detected, it is possible that the tire sensor has been damaged.

NOTE: Installing accessories that are not approved by Tesla can interfere with the TPMS.

Automatic Reset of TPMS Sensors

After replacing one or more wheels (but not after replacing a tire or rotating wheels), the TPMS sensors are reset to ensure tire pressure warnings are accurate. TPMS sensors reset automatically after driving over 25 km/h for longer than 10 minutes.

NOTE: After replacing a wheel, false tire pressure warnings may display before you've driven 25 km/h for longer than 10 minutes.

Replacing a Tire Sensor

If the Tire Pressure warning indicator displays frequently, use the mobile app to schedule a service appointment to determine if a tire sensor needs to be replaced. If a non-Tesla Service Center repairs or replaces a tire, the tire sensor may not work until Tesla performs the setup procedure.

Seasonal Tire Types

Understand Your Tire Type

The type of tires that your vehicle is originally equipped with depends on vehicle model and market region. It is important to understand the capabilities of your vehicle's tires and whether they are suited for summer, all-season, or winter driving. Check the information on the sidewall of a tire for information about a tire's performance characteristics (see [Understanding Tire Markings on page 210](#)).

Summer and All-Season Tires

Summer tires and all season tires are designed for maximum dry and wet road performance but are not designed to perform well in winter conditions. All-season tires are designed to provide adequate traction in most conditions year-round, but may not provide the same level of traction as winter tires in snowy or icy conditions. All-season tires can be identified by "ALL SEASON" and/or "M+S" (mud and snow) on the tire sidewall.

If driving in cold temperatures or on roads where snow or ice may be present, Tesla recommends using winter tires.



WARNING: In cold temperatures or on snow or ice, summer and all-season tires do not provide adequate traction. Selecting and installing the appropriate tires for winter conditions is important to ensure the safety and optimum performance of your Model X.

Winter Tires

Use winter tires to increase traction in snowy or icy conditions. When installing winter tires, always install a complete set of four tires at the same time. Winter tires must be the same diameter, brand, construction and tread pattern on all four wheels.



Winter tires can be identified by a mountain/snowflake symbol on the tire's sidewall.

When driving with winter tires, you may experience more road noise, shorter tread life, and less traction on dry roads.



WARNING: Never exceed the speed rating of your vehicle's tires. The speed rating is shown on the sidewall of your tires (see [Understanding Tire Markings on page 210](#)).

Driving in Low Temperatures

Tire performance is reduced in low ambient temperatures, resulting in reduced grip and an increased susceptibility to damage from impacts. Performance tires (summer applications) have reduced traction in ambient temperatures below 5° C, and are not recommended in snow/ice conditions. Performance tires can temporarily harden when cold, causing you to hear rotational noise for the first few kilometers until the tires warm up.

Using Tire Chains

Tesla has tested and approved the following tire chains (also called snow chains) to increase traction in snowy conditions. Tire chains should only be installed on the rear tires. The approved tire chains can be purchased from Tesla.

Tire Size	Recommended Chain
20"/22"	König K-Summit K67



CAUTION: Do not put tire chains on summer tires. Doing so can cause damage.

When installing tire chains, follow the instructions and warnings provided by the tire chain manufacturer. Mount them evenly and as tight as possible.

When using tire chains:

- Inspect the tire chains for loose fittings and damaged links before each use.





Tire Care and Maintenance

- Set air suspension to Standard (see [Air Suspension on page 90](#)).
- Avoid heavily loading Model X (heavy loads can reduce the clearance between the tires and the body).
- Do not drive the vehicle without the chains properly installed.
- Drive slowly. Do not exceed 48 km/h.
- Remove the tire chains as soon as conditions allow.

NOTE: Tire chains are prohibited in some jurisdictions. Check local laws before installing tire chains.

 **CAUTION:** Air suspension should remain in the **Medium** ride height setting to avoid damage.

 **CAUTION:** Using non-recommended tire chains, or using tire chains on other sized tires can damage the suspension, body, wheels, and/or brake lines. Damage caused by using non-recommended tire chains, or incorrectly installing tire chains, is not covered by the warranty.

 **CAUTION:** Do not use snow chains on the front tires.

 **CAUTION:** Never deflate your tires to put on tire chains. When re-inflated, the chains might fit too tightly and cause tire damage.

 **CAUTION:** Ensure that the tire chains cannot touch suspension components or brake lines. If you hear the chains making unusual noises that would indicate contact with Model X, stop and investigate immediately.

Cleaning the Exterior

To prevent damage to the paint, immediately remove corrosive substances (grease, oil, bird droppings, tree resin, dead insects, tar spots, road salt, industrial fallout, etc.). Do not wait until Model X is due for a complete wash. If necessary, use denatured alcohol to remove tar spots and stubborn grease stains, then immediately wash the area with water and a mild, non-detergent soap to remove the alcohol.

Keep the exterior cameras free of dirt, condensation, or obstructions. These substances can cause unclear pictures or Autopilot and safety features to stop working (see [Cleaning a Camera on page 191](#)).

Follow these steps when washing the exterior of Model X:

1. Before washing, flush grime and grit from the vehicle using a hose. Flush away accumulations of mud in areas where debris easily collects (such as wheel wells and panel seams). If salt has been used on the highways (such as during winter months), thoroughly rinse all traces of road salt from the underside of the vehicle, wheel wells, and brakes.
2. Hand wash Model X using a clean soft cloth and cold or lukewarm water and a mild, high-quality car shampoo.

 **CAUTION:** Some cleaners and car shampoos contain chemicals that can cause damage or discoloration, especially for plastic trim pieces, exterior lights, or camera lenses. For example, some car cleaning formulas contain hydroxide or other highly alkaline or caustic ingredients that can damage exterior components. Do not use acidic products either. Damage or discoloration resulting from cleaning products is not covered by the warranty.

3. After washing, rinse with clean water to prevent soap from drying on the surfaces.
4. Dry thoroughly with a chamois. If necessary, dry the brakes by going on a short drive and applying the brakes multiple times.

Use isopropyl alcohol wipes (such as those used to clean glasses or screens) to clean away small stains.

Window Cleaning and Treatments

Clean windows and mirrors using an automotive glass cleaner. Do not scrape or use any abrasive cleaning fluid on glass or mirrored surfaces. Follow the directions in [Cleaning the Exterior on page 191](#) for best practices in cleaning the exterior glass.

To add a hydrophobic coating to your vehicle's windows, apply the coating only to the side and rear windows, not the front windshield—doing so may affect the visibility of the autopilot cameras. Follow the hydrophobic coating manufacturer's instructions for application details.

NOTE: Tesla is not responsible for any damage associated with applying window treatments on your vehicle.

Cleaning a Camera

To ensure a clear picture, the camera lens must be clean and free of obstructions.

Remove any build-up of dirt or debris by spraying water onto the camera lens with a spray bottle. Do not attempt to remove dirt or debris by wiping an exposed lens with your hands or a cloth. This debris can damage the surface of the lens when rubbed against it during wiping.

NOTE: The inside of the windshield within front camera enclosure (see [Cameras on page 19](#)) must be cleaned periodically to maintain clear visibility and optimal camera function. To check if such cleaning is needed, review your vehicle's maintenance summary by touching **Controls** > **Service** > **Maintenance**. When needed, use the mobile app to schedule a service appointment.

 **CAUTION:** Do not use chemical-based or abrasive cleaners. Doing so can damage the surface of the lens.

 **CAUTION:** Do not clean an ultrasonic sensor (if equipped) or camera lens with a sharp or abrasive object that can scratch or damage its surface.

Cautions for Exterior Cleaning

 **CAUTION:** Do not wash in direct sunlight.

 **CAUTION:** Do not use windshield treatment fluids. Doing so can interfere with wiper friction and cause a chattering sound.

 **CAUTION:** Do not use hot water, detergents, highly alkaline or caustic cleaning ingredients or solvents, specifically those containing hydroxide. Avoid exposure to soaps and chemicals above pH 13. If unsure, check the product label or ask the staff at the car wash. Damage caused by improper washing is not covered by the warranty.

 **CAUTION:** If using a pressure washer, maintain a distance of at least 30 cm between the nozzle and the surface of Model X. Avoid aiming the water jet directly at parking sensors (if equipped). Keep the nozzle moving and do not concentrate the water jet on any one area.

 **CAUTION:** Do not aim water hoses directly at windows, door, or hood seals or at electronic modules or exposed cabling.

 **CAUTION:** To avoid corrosive damage that may not be covered by the warranty, rinse away any road salt from the underside of the vehicle, wheel wells, and brakes. After cleaning the vehicle, dry the brakes by going on a short drive and applying the brakes multiple times.

 **CAUTION:** Avoid using tight-napped or rough cloths, such as washing mitts. A high-quality microfiber cleaning cloth is recommended.



Cleaning

- ⚠ CAUTION:** If washing in an automatic car wash, use touchless car washes only. These car washes have no parts, such as brushes, that touch the surfaces of Model X.
- ⚠ CAUTION:** If washing in an automatic car wash, make sure the vehicle is locked. In addition, avoid using controls on the touchscreen that can result in accidentally opening doors or trunks while the vehicle is being washed. Any damage caused is not covered by the warranty.
- ⚠ CAUTION:** Ensure the wipers are off before washing Model X to avoid the risk of damaging the wipers.
- ⚠ CAUTION:** Do not use chemical based wheel cleaners or pre-wash products. These can damage the finish on the wheels.
- ⚠ WARNING:** Never spray liquid at a high velocity (for example, if using a pressure washer) towards the charge port while Model X is charging. Failure to follow these instructions can result in serious injury or damage to the vehicle, charging equipment, or property.

Cleaning the Interior

Frequently inspect and clean the interior to maintain its appearance and to prevent premature wear. If possible, immediately wipe up spills and remove marks. For general cleaning, wipe interior surfaces using a soft cloth (such as microfiber) dampened with a mixture of warm water and mild non-detergent cleaner (test all cleaners on a concealed area before use). To avoid streaks, dry immediately with a soft lint-free cloth.

Interior Glass

Do not scrape, or use any abrasive cleaning fluid on glass or mirrored surfaces. This can damage the reflective surface of the mirror and the heating elements in the rear window.

Airbags

Do not allow any substance to enter an airbag cover. This could affect correct operation.

Dashboard and Plastic Surfaces

Do not polish the upper surfaces of the dashboard. Polished surfaces are reflective and could interfere with your driving view.

Interior Lighting

NOTE: The Tesla warranty does not cover damage caused by improper maintenance, including the use of cleaning solutions or tools that are not recommended in this Owner's Manual.

Do not use any soap or chemical cleaning solutions on interior lighting. Common cleaning solutions and substances can degrade the lenses or components of the lighting, causing cracks and damage over time. When you want to clean interior lighting, Tesla recommends that you use a soft cloth moistened with warm water to gently wipe away soiled areas or stains. Interior lighting includes, but is not limited to, these lights (if equipped):

- Footwell
- Puddle
- Projection
- Dome
- Ambient

When you want to clean the interior with soap or a mild non-detergent cleaner, Tesla recommends that you first cover all lighting with some form of protection, such as:

- Fabric.
- Masking tape.
- Plastic film.
- Protective covers for car interiors.

Seats

NOTE: The Tesla warranty does not cover damage caused by improper maintenance, including the use of cleaning solutions or tools that are not recommended in this Owner's Manual.

Your vehicle's seats are made of a custom, sustainable, vegan leather which is softer than leather, yet far more durable and stain resistant. Tesla recommends that you regularly clean and vacuum the interior of your vehicle to maintain performance and an as-new appearance. You can purchase an all-purpose cleaning kit on the [Tesla Shop](#).

Avoid contact with harsh chemicals, including certain cosmetics. Such substances can cause damage, degradation, or discoloration over time.

For general spills and stains, wipe spills and chemical residues from interior surfaces as soon as possible. Moisten a soft cloth (preferably microfiber) with warm water and mild soap and gently wipe the stain in a circular motion. Then, wipe dry using a soft, lint-free cloth. Do not blow dry. Anything more than soap can be too harsh. Using other cleaning agents, disinfectants, conditioners, or protectants is not recommended.

For white seats: As a last resort, moisten a soft cloth (such as microfiber) with warm water and isopropyl alcohol and gently wipe the stain in a circular motion (DO NOT use this method on black seats). Clean off any remaining isopropyl alcohol residue with a soft, damp cloth. Aggressive or extended use of isopropyl alcohol will damage the top coat of the material, allowing stains to occur more readily and violating the warranty.



CAUTION: Do not use products containing alcohol, bleach (sodium hypochlorite), citrus, naphtha, or silicon-based additives. Do not spray the seat directly with any spray. Do not get water into the seat belt mechanism.

A variety of clothing, accessories, and cosmetics may contain dyes or oils which can transfer onto the seats over time. These stains are difficult to prevent and cannot always be safely cleaned off.

CAUTION: Do not use aftermarket, non-Tesla seat covers. Seat covers may cause staining or damage to the seats and may inhibit the sensitivity of a seat's occupancy sensors or restrict deployment of airbags.

If equipped with leather seats, note that leather is prone to dye-transfer which can cause discoloration, particularly on light colored leather. White and tan leather is coated with an anti-soiling treatment. Using detergents or commercially available leather cleaners and conditioners is not recommended because they can discolor or dry out the leather.

Carpets

Avoid over-wetting carpets. For heavily soiled areas, use a diluted upholstery cleaner.

Seat Belts

Extend the belts to wipe. Do not use any type of detergent or chemical cleaning agent. Allow the belts to dry naturally while extended, preferably away from direct sunlight.

Door Seals

Wipe door seals with a damp cloth to remove any debris. Excessive debris on the door seals can cause damage when contacting surrounding surfaces. Avoid using alcohol wipes or any chemical products that can potentially deteriorate the coating on the door seals.

Touchscreen and Instrument Panel

Clean the touchscreen(s) and instrument panel using a soft lint-free cloth specifically designed to clean monitors and displays. Do not use cleaners (such as a glass cleaner) or alcohol-based gel products (such as hand sanitizer) and do not use a wet wipe or a dry statically-charged cloth (such as a recently washed microfiber). To wipe the front touchscreen without activating buttons and changing settings, you can enable Screen Clean Mode. Touch **Controls > Display > Screen Clean Mode**. The display darkens to make it easy to see dust and smudges. To exit Screen Clean Mode, press and hold **HOLD TO EXIT**.

Chrome and Metal Surfaces

Polish, abrasive cleaners, alcohol-based gel products (such as hand sanitizer), and hard cloths can damage the finish on chrome and metal surfaces.

Cautions for Interior Cleaning

- CAUTION:** Using solvents (including alcohol), alcohol-based gel products (such as hand sanitizer), bleach, citrus, naphtha, or silicone-based products or additives on interior components can cause damage.
- CAUTION:** Statically-charged materials can cause damage to the touchscreen or instrument panel.
- WARNING:** If you notice any damage on an airbag or seat belt, contact Tesla immediately.
- WARNING:** Do not allow any water, cleaners, or fabric to enter a seat belt mechanism.
- WARNING:** Exposure to chemical cleaners can be hazardous and can irritate eyes and skin. Read and observe the instructions provided by the manufacturer of the chemical cleaner.

Polishing, Touch Up, and Body Repair

To preserve the cosmetic appearance of the body, you can occasionally treat the paint surfaces with an approved polish containing:

- Very mild abrasive to remove surface contamination without removing or damaging the paint.
- Filling compounds that fill scratches and reduce their visibility.
- Wax to provide a protective coating between the paint and environmental elements.

Regularly inspect the exterior paint for damage. Treat minor chips and scratches using a paint touch-up pen (available for purchase from Tesla, depending on market region). Use the touch-up pen after washing but before polishing or waxing.

Repair rock chips, fractures or scratches. Refer to <https://www.tesla.com/support/body-shop-support> for more information on repair locations and available services.

- CAUTION:** Do not use cutting pastes, color restoration compounds, or polishes containing harsh abrasives. These can scour the surface and permanently damage the paint.
- CAUTION:** Do not use chrome polish or other abrasive cleaners.

Using a Car Cover

To preserve the cosmetic appearance of the body when Model X is not being used, use a genuine Tesla car cover. Car covers can be purchased online from the Tesla Shop.

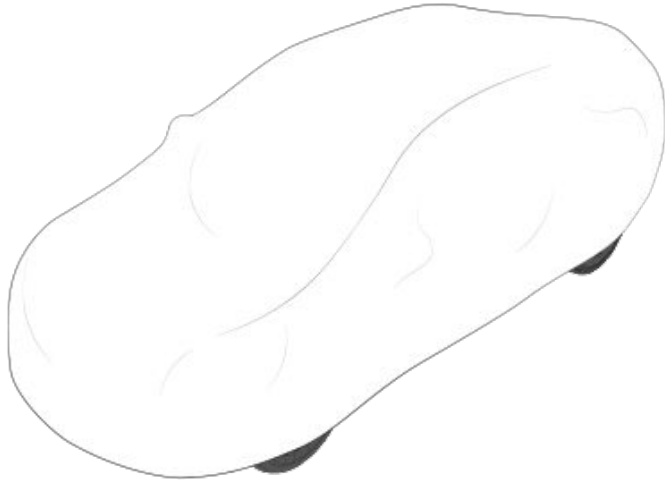

⚠ CAUTION: Use only a Tesla-approved car cover when Model X is plugged in. Using a non-Tesla car cover can prevent the Battery from being adequately cooled during charging.

Floor Mats

To extend the life of your carpet and make them easier to clean, use genuine Tesla floor mats available online at <http://www.tesla.com>. Maintain floor mats by regularly cleaning them and checking that they are properly attached. Replace floor mats if they become excessively worn.

⚠ WARNING: To avoid potential interference with a foot pedal, ensure that the driver's floor mat is securely fastened, and never place an additional floor mat on top of it. Floor mats should always rest on top of the vehicle carpeting surface and not on another floor mat or other covering.



Topping Up Windshield Washer Fluid

The only reservoir into which you can add fluid is the windshield washer fluid reservoir, which is located behind the front trunk. When the level is low, a message displays on the instrument panel.

To top up the washer fluid:

1. Open the hood.
2. Clean around the filler cap before opening it to prevent dirt from entering the reservoir.
3. Open the filler cap.
4. While avoiding spilling, fill the reservoir until the fluid level is visible just below the filler neck.

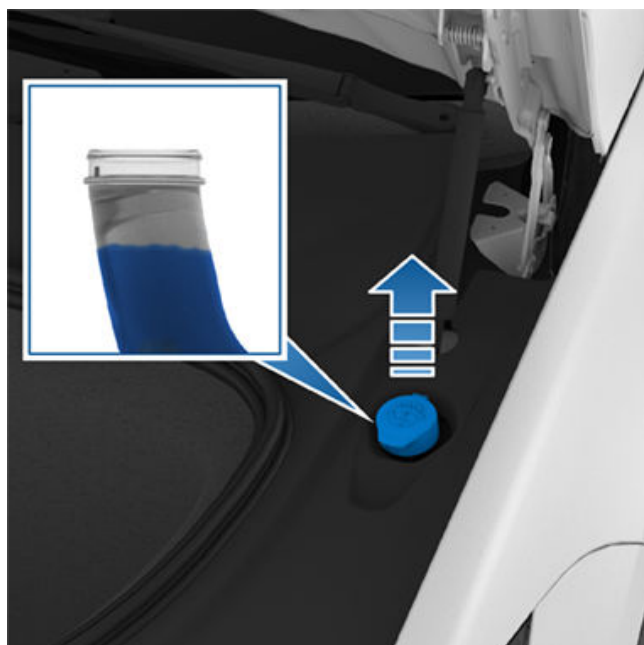

5. Wipe up any spills immediately and wash the affected area with water.
6. Reinstall the filler cap.

NOTE: Some national or local regulations restrict the use of Volatile Organic Compounds (VOCs). VOCs are commonly used as antifreeze in washer fluid. Use a washer fluid with limited VOC content only if it provides adequate freeze resistance for all climates in which you drive Model X.

CAUTION: Use only ethanol-based windshield washer fluid meant for automotive vehicles. Using other substances, such as untreated water, can result in bacterial growth within the climate control system resulting in odor or potential damage that is not covered by warranty.

CAUTION: Do not add formulated washer fluids that contain water repellent or bug wash. These fluids can cause streaking, smearing, and squeaking or other noises.

WARNING: In temperatures below 4° C, use a washer fluid with antifreeze. In cold weather, using a washer fluid without antifreeze can impair visibility through the windshield.

WARNING: Windshield washer fluid can irritate eyes and skin. Read and observe the instructions provided by the washer fluid manufacturer.

Checking and Cleaning Wiper Blades

Periodically clean the edge of the wiper blades and check the rubber for cracks, splits, and roughness. If damaged, replace the blade immediately to prevent damage to the glass and improve visibility.

Contaminants on the windshield, or on the wiper blades, can reduce the effectiveness of the wipers. Contaminants include ice, wax spray from car washes, washer fluid with bug and/or water repellent, bird droppings, tree sap, and other organic substances.

Follow these guidelines for cleaning:

- Clean the windshield and wiper blades using washer fluid, isopropyl (rubbing) alcohol, or non-abrasive glass cleaner approved for use on automotive glass and rubber. Inappropriate products can cause damage or smears, and create glare on the windshield.
- Lift the wiper arm a short distance away from the windshield, just far enough to access the wiper blade. Do not lift a wiper arm beyond its intended position.

If the wipers remain ineffective after cleaning, replace the wiper blades.

NOTE: Ineffective wipers can lead to reduced visibility for the front windshield cameras, which may lead to degraded performance or unavailability of Autopilot features. For more information, see [Cameras on page 19](#) and refer to [Autopilot Limitations and Warnings on page 131](#).

Replacing Wiper Blades

For optimum performance, replace the wiper blades at least once a year. Replacement blades must meet the following criteria:

- The blade on the driver's side must be 650 mm long and 530 mm long for the blade on the passenger's side.
- Ensure the connector on the replacement blade is the same as the original blade. Different connectors may prevent the replacement blade from connecting to the wiper arm on the vehicle.

You can purchase replacement wiper blades on the [Tesla Shop](#).

NOTE: Only install replacement blades that are identical to the original blades. Using inappropriate blades can damage the wiper system and windshield.



Windshield Wiper Blades, Jets and Fluid

NOTE: The wiper washing system is an integrated part of the wiper blades on Model X.

To replace the wiper blades:

1. Shift into Park and turn off the wipers.
2. Touch **Controls > Service > Wiper Service Mode** to move the wipers to the service position.
3. Lift the wiper arm a short distance away from the windshield, just far enough to access the wiper blade.

CAUTION: Wiper blades do not lock into a lifted position. Do not lift a wiper arm beyond its intended position.

4. Squeeze the two tabs to release the wiper blade from the wiper arm.

CAUTION: The wiper blade is still connected to the washer hose and cannot be removed yet.

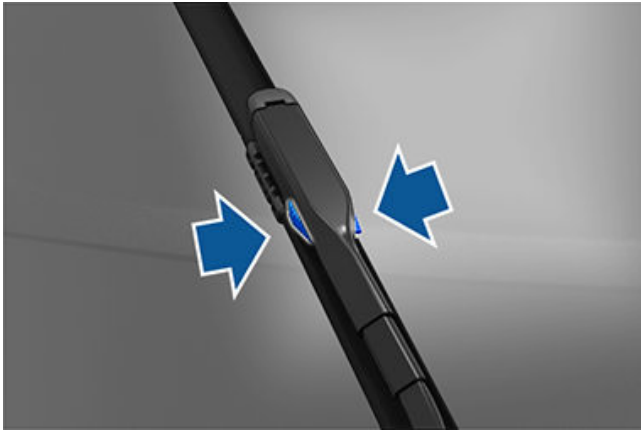

5. Place a towel between the wiper arm and windshield to avoid scratching or cracking the windshield.
6. Disconnect the washer hose from the wiper blade, taking care to avoid spilling any washer fluid.



7. Hold the wiper arm and press the locking tab while sliding the blade down the arm.
8. Fully insert the washer hose onto the nipple of the new wiper blade.

9. Align the new wiper blade on the wiper arm and slide it toward the end of the wiper arm until it locks into place.

CAUTION: Ensure the new blade is locked in place and does not move. Perform a push-pull test to confirm. If not locked in place (you can hear and feel a "click"), the wiper blade may come off during use, resulting in serious damage.

10. Turn Wiper Service Mode off to return the wipers to their normal position.

Cleaning Washer Jets

If a windshield washer jet becomes blocked, use a thin strand of wire to clear any blockages from the nozzles.

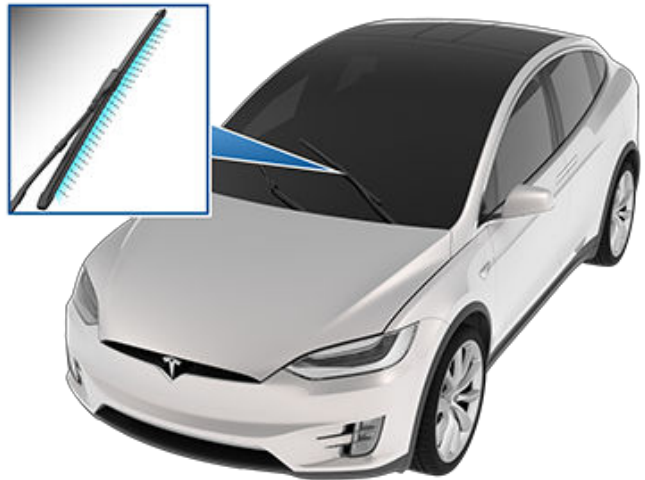

WARNING: Do not operate the washers while cleaning Model X. Windshield washer fluid can irritate eyes and skin. Read and observe the washer fluid manufacturer's instructions.



Follow the steps below to lift Model X. Ensure that any non-Tesla repair facility is aware of these instructions, including lift points and warnings.

1. Position Model X centrally between the lift posts.
2. If your Model X is equipped with air suspension, it automatically self-levels, even when the vehicle is "asleep" and the touchscreen is powered off (see [Jack Mode on page 197](#)). Use the touchscreen to set the suspension as follows:
 - Touch **Controls** > **Suspension**.
 - Press the brake pedal, then touch **Very High** to maximize the height of the suspension.
 - Touch **Controls** > **Service** > **Jack Mode** to disable self-leveling.
3. Close the falcon wing doors.
4. Position the lift arm pads under the designated body lift points at the locations shown.

WARNING: DO NOT position the lift arm pads under the Battery or side rails.

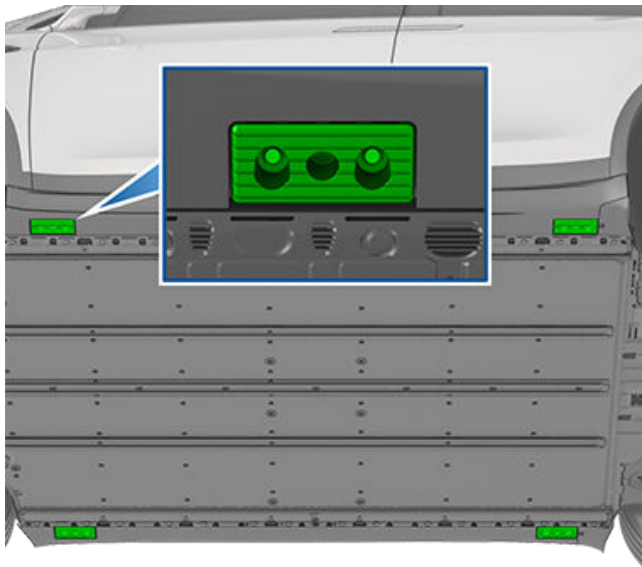

5. Adjust the height and position of the lift arm pads to ensure that they are correctly located.
6. With assistance, raise the lift to the desired height, ensuring the lift arm pads remain in their correct positions.
7. Engage any lift safety locks. Follow the lift manufacturer's instructions.
8. After lowering the vehicle, disengage Jack Mode by touching **Controls** > **Service**.

WARNING: The air suspension system automatically self-levels, even when the vehicle is "asleep" and the touchscreen is powered off. You **MUST** disable this system by engaging Jack mode before lifting or jacking. If you do not disable the air suspension, Model X can attempt to self-level, causing serious damage, bodily injury, or death.

WARNING: Never raise Model X when the charge cable is connected, even if charging is not in progress.

WARNING: Do not work on an incorrectly supported vehicle. Doing so can cause serious damage, bodily injury, or death.

CAUTION: It is your responsibility to be observant of the vehicle and it's surroundings. Ensure the area is clear when lifting and lowering Model X and that the doors, front trunk, and liftgate are closed as necessary to avoid damage.

CAUTION: DO NOT lift from under the Battery or side rails. Place the lift arm pads under the designated body lift points only. The locations shown are the only approved lifting points for Model X. Lifting at any other points can cause damage. Damage caused by incorrectly lifting Model X is not covered by the warranty.

Jack Mode

WARNING: Failure to enable Jack Mode can result in the vehicle self-leveling, resulting in damage, injury, or death.

If Model X is equipped with air suspension, it automatically self-levels, even when the vehicle is "asleep" and the touchscreen is powered off. To prevent damage when jacking or lifting the vehicle, you must activate Jack mode to disable self-leveling. Jack mode prevents the self-leveling that occurs automatically.

NOTE: Jack mode may be unexpectedly enabled in situations where an object is supporting the vehicle's weight (for example the bumper of the vehicle is resting on a curb).



Parts, Accessories, and Modifications

Use only genuine Tesla parts and accessories. Tesla performs rigorous testing on parts to ensure their suitability, safety, and reliability. Purchase these parts from Tesla, where they are professionally installed and where you can receive expert advice about modifications to Model X. Accessories are available for purchase from Tesla stores or online at www.tesla.com.

NOTE: Adding accessories to your vehicle may impact expected range, vehicle dimensions, etc.

NOTE: Some accessories may not be available in your market region.

Tesla is unable to assess parts manufactured by other distributors and therefore accepts no responsibility if you use non-Tesla parts on Model X.

 **WARNING:** Installing non-approved parts and accessories, or performing non-approved modifications, can affect the performance of Model X and the safety of its occupants. Any damage caused by using or installing non-approved parts, or by performing non-approved modifications, is not covered by the warranty.

 **WARNING:** Tesla does not accept liability for death, personal injury or damage that occurs if you use or install non-approved accessories or make non-approved modifications.

Body Repairs

If your Model X is in a collision, contact Tesla or a Tesla-approved Body Shop to ensure that it is repaired with genuine Tesla parts. Tesla has selected and approved body shops that meet strict requirements for training, equipment, quality, and customer satisfaction.

Some repair shops and insurance companies might suggest using non-original equipment or salvaged parts to save money. However, these parts do not meet Tesla's high standards for quality, fit and corrosion resistance. In addition, non-original equipment and salvaged parts (and any damage or failures they might cause) are not covered by the warranty.

Using RFID Transponders

When attaching an RFID transponder (used by many automated toll systems) inside Model X, place the transponder near the topmost area of the windshield. This ensures best results and minimizes any obstruction to your driving view. Refer to the RFID manufacturer's instructions for specific placement.

NOTE: You can also attach a weather-proof transponder to the front license plate.



You can purchase the temporary tire repair kit on the [Tesla Shop](#).

⚠ WARNING:

- Do not drive on a deflated tire.
- Do not remove any foreign objects found embedded in the tire.
- Do not leave the compressor on for over 20 consecutive minutes.
- Do not drive at high speeds or long periods of time. The temporary repair is designed to get your vehicle immediately and safely to a tire repair shop. Driving on temporarily repaired tires for long periods of time may cause serious damage or injury.

⚠ CAUTION: Follow all directions and warnings on the tire inflation kit.

Tire Repair

The tire inflation kit is a temporary repair only. You must repair or replace a damaged tire as soon as possible. For punctures larger than 1/4" (6 mm), severe tread damage, a damaged sidewall, ripped tires or tires that have come off the rim, contact Roadside Assistance. To temporarily repair a tire:

1. Park your vehicle in a safe, open location.
2. Ensure the compressor is Off.
3. Remove the punctured tire valve cap on the vehicle and connect the transparent sealant tube to the valve opening.



4. Insert the electrical plug into one of the vehicle's low voltage sockets.

5. Turn the selector switch to the tire icon and turn On. Once the sealant has properly flowed into the tire, the gauge shows the current tire pressure. The ideal pressure is indicated on the driver's side door pillar of the vehicle. After several minutes, ensure the gauge shows the ideal tire pressure before continuing.

NOTE: If the gauge still indicates a pressure of less than 22 PSI (1.5 Bar) after 15 minutes of consecutive operation, disconnect the transparent sealant tube and screw the tire valve cap back on. Drive for a few feet (meters) to allow the sealant to distribute within the tire. Park Model X and re-try steps 2-5. If this still does not work, call Tesla Roadside Assistance.

6. Turn the kit Off and disconnect the tube from the tire. Screw the tire valve cap back on.
7. Drive within the indicated speed limit (shown on sticker on the tire repair kit) without suddenly accelerating or braking. After approximately 10 minutes of driving, park in a safe, open space again. Proceed to inflate the tire(s) now that the sealant has been distributed in the tire.

⚠ WARNING: The sealant liquid is efficient at temperatures between -40°F (-40°C) and 122° F (50°C). Do not use sealant liquid after the expiration date indicated on the label. See [Canister Replacement on page 200](#) for more information on replacing a used or expired canister.

Tire Inflation

1. Make sure tire compressor is Off.
2. Turn the switch to the pump icon.
3. Insert the electrical plug into one of the vehicle's low voltage sockets.
4. Remove the tire valve cap and connect the black inflation tube to the valve opening.





Temporary Tire Repair Kit

5. Turn the compressor On until it reaches the ideal pressure indicated on the driver's side door pillar of the vehicle.
6. Remove the black inflation tube and replace the tire valve cap.
7. Turn the compressor Off and store in a safe, dry place.

Canister Replacement

1. Purchase refills from the manufacturer or online from <https://shop.tesla.com/>.
2. Remove the used canister by taking out the transparent sealant tube and setting it aside.
3. Press the red release button while lifting out the canister.
4. Insert the new canister by pressing it firmly into the case. Re-attach the transparent sealant tube. Take note of the new canister's expiration date.



5. Dispose of the empty canister properly according to local regulations.



Learn how to perform simple Do It Yourself procedures, such as replacing wiper blades and cabin filters, or installing the paint protection film kit. Go to <https://www.tesla.com/support/do-it-yourself-guides> for instructions, animations, and videos of these procedures.

NOTE: Due to market region or vehicle configuration specifics, some parts and procedures may not be available for your vehicle. When navigating to <https://www.tesla.com/support/do-it-yourself-guides>, select your vehicle, region, and/or language to see an updated list of parts and accessories available for your region.



CAUTION: Perform each procedure in a dry and well-lit area. For your safety, only perform a procedure if you feel comfortable doing so, and always follow provided instructions.



Identification Labels

Vehicle Identification Number

You can find the VIN at the following locations:

- Touch **Controls** > **Software**.
- Stamped on a plate located at the top of the dashboard. Can be seen by looking through the windshield.
- Stamped on the chassis under the sill panel on the rear passenger door. To remove the sill panel, gently pry it upward using a flat-bladed tool.

! **CAUTION:** Removing the sill panel to view the VIN is not recommended because damage is likely to occur. The panel is held in place with fragile clips that break easily. Damage caused by removing the sill panel is not covered by the warranty.

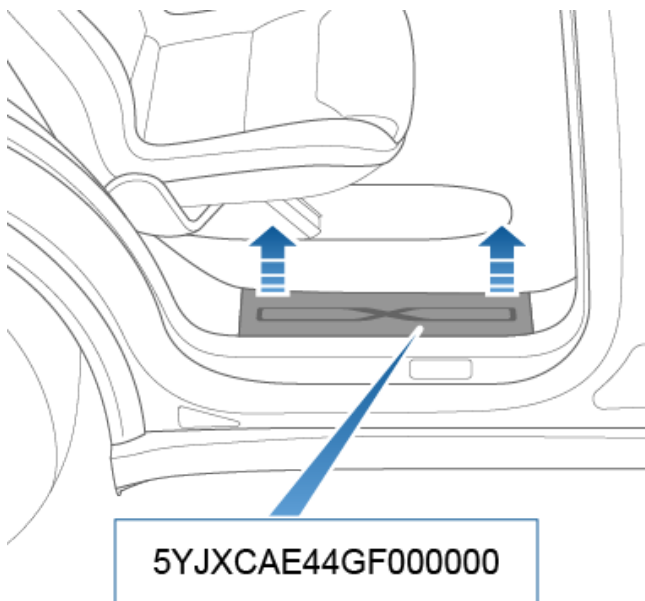

Vehicle Labeling

It is important to understand your vehicle's original tire sizes and pressures, and the TPMLM (Technically Permissible Maximum Label Mass) and TPMAM (Technically Permissible Maximum Mass on Axle). This information can be found on two labels attached to Model X.

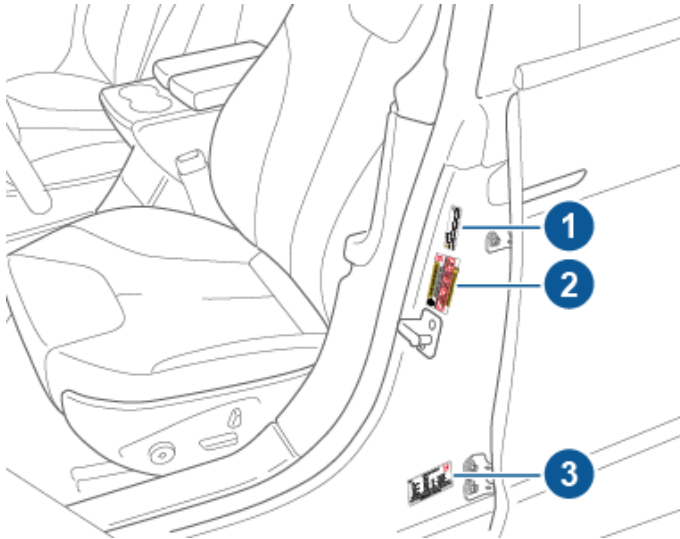

1. Towing label (if equipped)
2. Tire Information Label
3. Statutory Plate

NOTE: Towing capability is available only if Model X is equipped with the Towing Package.

⚠ WARNING: Overloading Model X has an adverse effect on braking and handling, which can compromise your safety or cause damage.

⚠ CAUTION: Never store large amounts of liquid in Model X. A significant spill can cause electrical components to malfunction.

Towing Label

NOTE: Depending on date the vehicle was manufactured, Model X may or may not have a towing label.

Towing capability is available only if Model X is equipped with the Towing Package. If equipped with the towing package, the Towing Label instructs you to refer to the owner's manual for tire pressures that should be used when towing a trailer. Do not use the tire pressures printed on the Tire Information Label. Instead, see the topic "Towing a Trailer" in the Driving section of the onscreen Owner's Manual.

⚠ IMPORTANT!
For towing and high speed driving, please refer to  owner's manual for tire inflation pressure requirements.

Tire Information Label

The Tire Information label provides:

- The maximum number of occupant seating positions.
- The size of the original tires.
- The cold inflation pressures for the original front and rear tires. These pressures are recommended to optimize ride and handling characteristics.

Label Format:

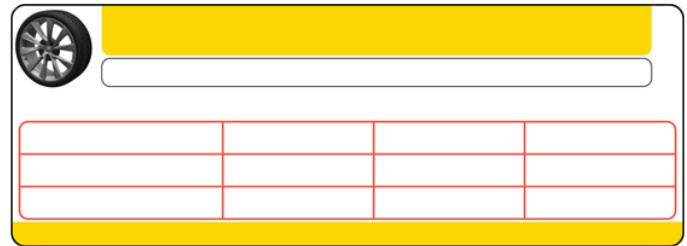

Never change this label, even if you use different tires in the future.

NOTE: If Model X is loaded to its full capacity, double check all tires to ensure they are inflated to their recommended pressure levels.

⚠ WARNING: Tire pressures printed on the Tire Information label **DO NOT APPLY** to towing. When towing, tire pressures must be increased. For information about the tire pressures required when towing, see [Towing and Accessories on page 104](#).

Statutory Plate

In addition to the VIN, the Statutory Plate provides:

- TPMLM - Technically Permissible Maximum Laden Mass. The maximum allowable total mass of Model X. This is calculated as the weight of Model X, all passengers, fluids, and cargo.
- TPMAM - Technically Permissible Maximum Mass on Axle, for the front and rear axles. The TPMAM is the maximum distributed weight that each axle can support.

⚠ CAUTION: To prevent damage, never load Model X so that it is heavier than TPMLM or exceeds the individual TPMAM weights.



Dimensions

Exterior Dimensions

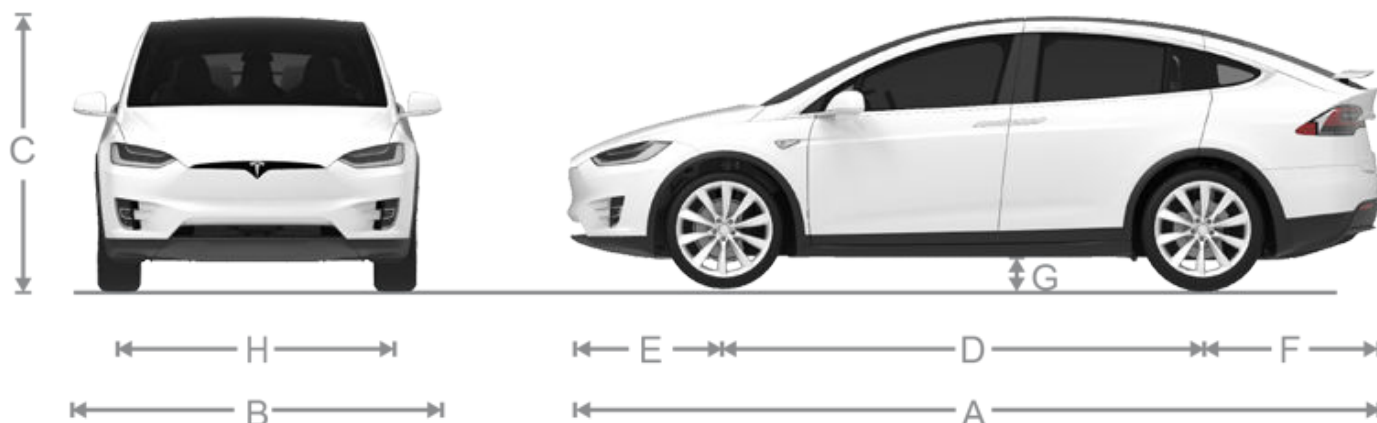

A	Overall Length	198.9 in	5,052 mm
B	Overall Width (including mirrors)	89.4 in	2,271 mm
	Overall Width (including folded mirrors)	81.6 in	2,072 mm
	Overall Width (excluding mirrors)	78.7 in	1,999 mm
C	Overall Height	66 in*	1,684 mm*
D	Wheel Base	116.7 in	2,965 mm
E	Overhang - Front	38.9 in	989 mm
F	Overhang - Rear	43.2 in	1,098 mm
G	Ground Clearance:		
	Standard, with skis	7 in	171 mm
	Standard, without skis	7 in	183 mm
	Very high, with skis	8 in	211 mm
	Very high, without skis	9 in	223 mm
H	Track - Front	67.1 in	1,705 mm
	Track - Rear	67.3 in	1,710 mm

*Values are approximate. Dimensions can vary depending on a vehicle's options and various other factors.

**The track of the vehicle is based on measurements at the wheel center.

⚠ CAUTION: Depending on configuration (such as suspension height or wheel selection), your vehicle's liftgate can open up to approximately 2.5 meters high. See [Adjusting Liftgate Opening Height on page 30](#) to adjust the liftgate height and prevent it from coming into contact with low ceilings or other objects.

Interior Dimensions

Head Room	Front	41.7 in	1059 mm
	Rear	40.9 in	1039 mm
	Third	37.1 in	942 mm



Leg Room	Front	41.2 in	1046 mm
	Rear	38.4 in	975 mm
	Third	32.7 in	831 mm
Shoulder Room	Front	60.7 in	1542 mm
	Rear	56.8 in	1442 mm
	Third	40 in	1016 mm
Hip Room	Front	55.6 in	1412 mm
	Rear	59 in	1498 mm
	Third	38.5 in	978 mm

Cargo Volume

	Front Trunk	Rear*	Total
Seven Seat Vehicles	6.6 cu ft (187 L)	76.5 cu ft (2166 L)**	83.1 cu ft (2353 L)
Six Seat Vehicles	6.6 cu ft (187 L)	70.7 cu ft (2002 L)**	77.3 cu ft (2189 L)
Five Seat Vehicles	6.6 cu ft (187 L)	81.2 cu ft (2299.5 L)**	87.8 cu ft (2486.5 L)

* Maximum cargo volume behind the front row seats. Includes the 12.6 cu ft (357 L) cargo area in the rear trunk (area behind the third row seats, if equipped).

** Second row seats fully forward and/or folded.



Motor Type

Motor	Specifications
Front Motor	AC permanent magnet synchronous motor, liquid-cooled, with variable frequency drive
Rear Motor	AC induction motor, liquid-cooled, with variable frequency drive
Nominal Voltage	320 volts

Maximum Motor Power

Trim	Location	Rated Max Power*
Standard Range	Front	205 kW
	Rear	210 kW
Long Range	Front	205 kW
	Rear	210 kW
Performance	Front	205 kW
	Rear	375 kW

*Tested in accordance with ECE R85.

Maximum Motor Torque

Trim	Location	Nm
Standard Range	Front	420
	Rear	335
Long Range	Front	420
	Rear	335
Performance	Front	420
	Rear	720

Transmission

Type	Specifications
Type	Single speed fixed gear

Type	Specifications
Overall Final Drive Ratio	Small motor: 9.0:1 Large motor: 9.7:1
Reverse Gear	Reverse direction of motor, limited to 24 km/h

Steering

Steering	Specifications
Type	Variable rack and pinion with electronic power steering, speed sensitive
Number of turns lock to lock	2.33
Turning Circle (curb to curb)	40.3 ft/12.3 m

Brakes

Brakes	Specifications
Type	4-wheel anti-lock braking system (ABS) with Electronic Brake Force Distribution, Integrated Advanced Stability Control and Electronic Accelerator pedal actuated regenerative braking system
Rotor Diameters (ventilated)	Front: 13.98"/355 mm Rear: 14.37"/365 mm
Front Rotor thickness	New: 1.26"/32 mm Service limit: 1.18"/30 mm
Rear Rotor thickness	New: 1.10"/28 mm Service limit: 1.02"/26 mm
Front Brake Pad Thickness (excluding back plate)	0.346"/8.8 mm
Rear Brake Pad Thickness (excluding back plate)	0.354"/9 mm
Parking brake	Electrically actuated parking brake calipers
Brake Disc Friction Pair	Front: .31"/8 mm Rear: .28"/7 mm

Suspension

Suspension	Specifications
Front	Independent, virtual pivot double wishbone
Rear	Independent, virtual pivot double wishbone



Battery - Low Voltage

Battery - Low Voltage	Specifications
Rating	33 amp hour or higher
Voltage and Polarity	Low voltage negative (-) ground

Battery - High Voltage

Battery - High Voltage	Specifications
Type	Liquid-cooled lithium ion (Li-ion)
Temperature Range	Do not expose Model X to ambient temperatures above 60° C or below -30° C for more than 24 hours at a time.



Wheel Specifications (Factory)

Wheel Type	Size	Offset
20" All Season - Front	20 x 9.0J	1.575" (40 mm)
20" All Season - Rear	20 x 9.5J	1.378" (35 mm)
20" Summer - Front	20 x 9.0J	1.575" (40 mm)
20" Summer - Rear	20 x 10.0J	1.378" (35 mm)
22" Summer - Front	22 x 9.0J	1.575" (40 mm)
22" Summer - Rear	22 x 10.0J	1.378" (35 mm)
Lug Nut Torque	129 lb. ft (175 Nm)	
Lug Nut Socket Size	21 mm	

NOTE: For instructions on how to jack/lift Model X, see [Jacking and Lifting on page 197](#).

Tire Specifications (Factory)

Tire Type	Size	Load Index / Speed Rating
20" - Michelin - Front	255/45R20	105 / Y
20" - Michelin - Rear	275/45R20	110 / Y
22" - Continental, Goodyear, or Pirelli - Front	265/35R22	102 / W
22" - Continental, Goodyear, or Pirelli - Rear	285/35R22	106 / W
Refer to the tire pressures printed on the Tire Information label. This label is located on the driver's door pillar and is visible when the driver's door is open (see Maintaining Tire Pressures on page 185).		
Winter tires can be purchased from a Tesla service center or may be available for purchase on the Tesla web site.		



Understanding Tire Markings

Laws require tire manufacturers to place standardized information on the sidewall of all tires. This information identifies and describes the fundamental characteristics of the tire.



1. **Tire category:** P indicates that the tire is for passenger vehicles.
2. **Tire width:** This 3-digit number is the width (in millimeters) of the tire from sidewall edge to sidewall edge.
3. **Aspect ratio:** This 2-digit number is the sidewall height as a percentage of the tread width. So, if the tread width is 205 mm, and the aspect ratio is 50, the sidewall height is 102 mm.
4. **Tire construction:** R indicates that the tire is of Radial ply construction.
5. **Wheel diameter:** This 2-digit number is the diameter of the wheel rim in inches.
6. **Load index:** This 2 or 3-digit number is the weight each tire can support. This number is not always shown.
7. **Speed rating:** When stated, indicates the maximum speed (in mph) at which the tire can be used for extended periods. Q=99 mph (160 km/h), R=106 mph (170 km/h), S=112 mph (180 km/h), T=118 mph (190 km/h), U=124 mph (200 km/h), H=130 mph (210 km/h), V=149 mph (240 km/h), W=168 mph (270 km/h), Y=186 mph (300 km/h), (Y)=vehicle's top speed (exceeds the "Y" rating).
8. **Tire composition and materials:** The number of plies in both the tread area and the sidewall area indicates how many layers of rubber coated material make up the structure of the tire. Information is also provided on the type of materials used.
9. **Maximum tire load:** The maximum load which can be carried by the tire.



10. **Maximum permissible inflation pressure:** This pressure should not be used for normal driving.
11. **U.S. DOT Tire Identification Number (TIN):** Begins with the letters DOT and indicates that the tire meets all federal standards. The next 2 digits/letters represent the plant code where it was manufactured, and the last 4 digits represent the week and year of manufacture. For example, the number 1712 is used to represent the 17th week of 2012. The other numbers are marketing codes used at the manufacturer's discretion. This information can be used to contact consumers if a tire defect requires a recall.
12. **Treadwear grade:** This number indicates the tire's wear rate. The higher the treadwear number is, the longer it should take for the tread to wear down. A tire rated at 400, for example, lasts twice as long as a tire rated at 200.
13. **Traction grade:** Indicates a tire's ability to stop on wet roads. A higher graded tire should allow you to stop your vehicle in a shorter distance than a tire with a lower grade. Traction is graded from highest to lowest as AA, A, B, and C.
14. **Temperature grade:** The tire's resistance to heat is grade A, B, or C, with A indicating the greatest resistance. This grading is provided for a correctly inflated tire, which is being used within its speed and loading limits.



Instructions for Transporters

DO NOT TRANSPORT WITH WHEELS ON THE GROUND

The front motor in Model X generates power when the wheels spin. Always transport Model X with all four tires off the ground. Ensure that the tires are unable to spin at any time during transport.

WARNING: NEVER TRANSPORT YOUR VEHICLE WITH THE TIRES IN A POSITION WHERE THEY CAN SPIN. DOING SO CAN LEAD TO SIGNIFICANT DAMAGE AND OVERHEATING. IN RARE CASES EXTREME OVERHEATING MAY CAUSE THE SURROUNDING COMPONENTS TO IGNITE.



Do not transport Model X using any method that is not specified by Tesla. Adhere to the instructions provided in the following sections and observe all warnings and cautions provided. Damage caused by improper transporting of your vehicle is not covered by the warranty.

NOTE: Tesla is not liable or responsible for reimbursing services not dispatched through Tesla Roadside Assistance.

Approved Methods for Transporting

NOTE: The tires are allowed to rotate slowly (under 5 km/h) and for a very short distance (less than 10 meters) only when Transport Mode is enabled (see [Activate Transport Mode on page 213](#)) while the vehicle is being winched onto a flatbed truck or pulled out of a parking space for repositioning. Exceeding these boundaries can lead to significant damage and overheating that is not covered by the warranty.

A flatbed truck or comparable transport vehicle is the recommended method of transporting Model X. The vehicle can face either direction when using a flatbed.



If Model X must be transported without a flatbed truck, then wheel lifts and dollies must be used to ensure that all four wheels are off of the ground. This method may only be used for a maximum of 55 km, and must not exceed the manufacturer speed rating of the dollies. With this method, Tesla recommends the vehicle facing forward so that the front wheels are lifted and the rear wheels are on dollies.

NOTE: Transporting Model X with the front wheels on dollies is not recommended, but may be done if an external steering wheel lock is applied and care is taken to prevent the front wheels from spinning. DO NOT TRANSPORT YOUR VEHICLE IF THERE IS ANY CHANCE OF THE FRONT WHEELS SPINNING.



CAUTION: Enable Transport Mode (see [Activate Transport Mode on page 213](#)) before winching Model X onto a flatbed truck (see [Pull onto the Flatbed Truck - With Tow Eye on page 213](#)). If Transport Mode is not available or the touchscreen is not accessible, self-loading dollies or tire skates must be used to load the vehicle into the approved transportation position. Tesla is not responsible for any damage caused by or during the transport of Model X, including personal property damage or damage caused by using self-loading dollies or tire skates.

WARNING: Model X is equipped with high voltage components that may be compromised as a result of a collision (see [High Voltage Components on page 168](#)). Before transporting Model X, it is important to assume these components are energized. Always follow high voltage safety precautions (wearing personal protection equipment, etc.) until emergency response professionals have evaluated the vehicle and can accurately confirm that all high voltage systems are no longer energized. Failure to do so may result in serious injury.

Disable the Self-Leveling Air Suspension System

If Model X is equipped with the air suspension system, it automatically self-levels, even when power is off. To prevent damage, you must activate Jack Mode to disable self-leveling:

1. Touch **Controls** > **Suspension** on the touchscreen.
2. Press the brake pedal, then touch **Very High** to maximize height.
3. Touch **Controls** > **Service** > **Jack Mode**.

NOTE: Jack Mode cancels when driving speed exceeds 7 kph.



⚠ WARNING: Failure to activate Jack Mode on a vehicle equipped with the air suspension system can result in the vehicle becoming loose during transport, which may cause significant damage.

Activate Transport Mode

Transport Mode keeps the parking brake disengaged while winching Model X onto a flatbed truck. When active, Transport Mode displays a message indicating that the vehicle will remain free-rolling. The following are required to enable Transport Mode:

- Low voltage power is required. You are unable to use the touchscreen to activate Transport Mode if Model X has no power.
- Model X must detect a key fob. Transport Mode is available only when a key fob is detected.
- Ensure the vehicle is not connected to a charger. Transport Mode is not available if Model X is still plugged in.

To activate Transport Mode:

1. Ensure the vehicle is in Park.
2. Chock the tires or otherwise ensure Model X is secure.
3. Press and hold the brake pedal, then on the touchscreen, touch **Controls** > **Service** > **Towing**. The touchscreen displays a message reminding you how to properly transport Model X.
4. Touch **Enter Transport Mode**. The button turns blue to show that Model X is now in Transport Mode. Model X is now free-rolling and can be rolled slowly (no faster than walking speed) for short distances or winched (for example, onto a flatbed truck).

To cancel Transport Mode, touch **Exit Transport Mode** or shift Model X into Park. If your phone key is not detected, canceling Transport Mode powers off Model X. You may need your key card to restart your vehicle.

NOTE: If Model X loses low voltage power after Transport Mode is enabled, Transport Mode cancels.

⚠ CAUTION: If the electrical system is not working, and you therefore cannot use the touchscreen to activate Transport Mode, use self-loading dollies or tire skates. Before doing so, always check the manufacturer's specifications and recommended loading capacity.

Pull onto the Flatbed Truck - With Tow Eye

1. Locate the tow eye.
2. Remove the tow eye cover by inserting a small flat screwdriver into the slot located along the top of the cover, then prying gently to release the cover from the top snap.



NOTE: Keep the tow eye cover in a safe place so you can replace it when towing is complete.

3. Fully insert the tow eye into the opening, then turn it counter-clockwise until securely fastened.



4. Attach the winch cable to the tow eye.

⚠ CAUTION: Before pulling, make sure the tow eye is securely fastened.

5. Activate Transport Mode by touching **Controls** > **Service** > **Towing**.
6. Pull Model X slowly onto the flatbed truck.



Instructions for Transporters

Pull onto the Flatbed Truck - Without Tow Eye

CAUTION: To avoid damage, only pull the vehicle onto a flatbed truck using a properly-installed tow eye. Using the chassis, frame, or suspension components to pull the vehicle can result in damage.

WARNING: If the vehicle is pulled onto the flatbed truck without a tow eye, all suspension fasteners should be checked for proper torque and all components should be visually inspected for damage prior to driving the vehicle again. If a fastener is loose, or if any damage is found, the affected component(s) should be replaced.

It is strongly recommended that you connect the winch to your vehicle's tow eye, as described previously. However, if a situation arises in which the tow eye is not available (lost, misplaced, etc.), the following instructions describe how to attach tow straps.

1. Attach the tow straps to each of the lower suspension arms underneath the front of the vehicle.



2. To protect the underbody from damage, place a protective barrier (such as a piece of wood) between the tow strap and underbody.
3. Activate Transport Mode by touching **Controls** > **Service** > **Towing**.
4. Pull Model X slowly onto the flatbed truck.

Secure the Tires

The vehicle's tires must be secured onto the truck using the eight-point tie-down method.

- Ensure any metal parts on the tie-down straps do not contact painted surfaces or the face of the wheels.
- Do not place tie-down straps over body panels or through the wheels.

CAUTION: Attaching the tie-down straps to the chassis, suspension or other parts of the vehicle's body may cause damage.



If Vehicle Has No Power

If Model X has no low voltage power, perform the following steps to open the hood or jump start the low voltage battery.

1. Open the hood. See [Opening the Hood with No Power on page 217](#) for more information on opening the hood if the vehicle does not have power.
2. Jump start the low voltage battery (see [Jump Starting on page 218](#)).

NOTE: Tow providers: See [Running Out of Range on page 216](#) for more information on transporting the vehicle to a charging station and preparing the vehicle to charge.



Tesla Roadside Assistance is available to you 24 hours a day, 365 days a year, for the duration of your warranty period. Tesla Roadside Assistance is also available to speak with roadside service professionals to answer any questions and explain the proper procedure for transporting your vehicle.

When contacting Tesla Roadside Assistance, please provide:

- The Vehicle Identification Number (VIN). The VIN is displayed when you touch **Controls > Software**. The VIN can also be seen by looking through the driver's side of the windshield.
- Your exact location.
- The nature of the problem.

If available in your region, you can also expedite your request, by choosing the Roadside Assistance option in the Tesla mobile app.

NOTE: For a detailed description of Tesla's Roadside Assistance policy, go to the support page on the Tesla web site for your region.

Regional Phone Number(s)

United Arab Emirates: [+971 4 5217699](tel:+97145217699)

NOTE: The phone number is also available by touching **Controls > Service**.



Running Out of Range

CAUTION: It is your responsibility to monitor the state of the high voltage Battery and the remaining range of your vehicle. Do not assume that there is any range available when the range displayed on the instrument cluster is at 0 km (or 0%). Damage to the low voltage battery due to running out of range is not covered by the warranty.

NOTE: In the unlikely event your vehicle runs out of range while driving, pull over when safe to do so and contact [Tesla Roadside Assistance on page 215](#) or your preferred tow provider.

If Model X runs out of range, the low voltage battery is no longer supported – and when low voltage is not supported, the vehicle cannot charge. Therefore, the low voltage battery must be supported by an external power supply to allow you to charge the High Voltage (HV) Battery. Once the vehicle begins charging, the external power supply is no longer required.

In the case of running out of range away from a charger, the tow provider should transport Model X to the nearest charging station and unload the vehicle within the charging cable's reach. Once the vehicle is positioned next to a charger, follow these instructions:

NOTE: If the vehicle is being transported to a charger, make sure the tow provider does not leave until confirming that the vehicle's high voltage Battery is successfully charging.

1. Jump start the low voltage system (see [Jump Starting on page 218](#)). The low voltage battery must be jump started to support the high voltage Battery.
2. Wait a few minutes. Once the touchscreen powers on, plug the charge cable into Model X to begin charging the high voltage Battery.
3. When Model X begins to charge, disconnect the external power supply from the low voltage battery.

Before transporting to a non-Tesla charger, ensure your vehicle is equipped with an adapter that accommodates the specific type of charging station you will be using. Even at a non-Tesla charger, you will need to jump start the low voltage system before you can begin charging.

CAUTION: Always ensure Model X has enough range for your drive, or for being stored for an extended period. Do not rely on the range estimates displayed on the touchscreen or mobile app as range can decrease faster than projected due to ambient temperature, driving habits, wind, vehicle settings (such as Sentry Mode), etc.

NOTE: Towing your vehicle as a result of running out of range is not covered by the warranty.



Opening the Hood with No Power

If Model X has no electrical power, or if you are unable to open the front trunk using the touchscreen or key, follow these steps to open it:

1. Remove the tow eye cover (see [Instructions for Transporters on page 212](#)).
2. Locate the two straps. One of these straps is labeled 'A' and the other is labeled 'B'.
3. Pull strap 'A' to release the primary latch.
4. Pull strap 'B' to release the secondary latch.
5. Lift the hood. You may need to push the hood down slightly to release the pressure against the secondary latch.

NOTE: It is important to pull the straps in the correct sequence or the appropriate latch does not release and the front trunk can not open.

When opening the front trunk using this method, the latches remain in the open position and you can not close it again without electrical power. To close a front trunk that has been opened by pulling the manual straps:

1. Charge the low voltage battery (for instructions, contact Tesla).
2. Press the **Front Trunk** button on the touchscreen to reset the primary and secondary latches.



Jump Starting

The following instructions assume you are using an external low voltage power supply (such as a portable jump starter). If jump starting Model X using another vehicle, refer to the vehicle manufacturer's instructions.

 **CAUTION:** Model X cannot be used to jump start another vehicle. Doing so can result in damage.

 **CAUTION:** Avoid short circuits when jump starting Model X. Connecting cables to the wrong jump post, touching leads together, etc., can damage Model X.

Follow these steps:

Ensure you have an external power supply. After opening the hood:

1. Remove the maintenance panel.
2. Find the positive (+) and negative (-) jump posts.
3. Release the cover from the red positive (+) jump post, and then connect the low voltage power supply's red positive (+) cable to the red positive (+) jump post.
4. Connect the low voltage power supply's black negative (-) cable to the vehicle.
5. Turn on the external power supply (refer to the manufacturer's instructions). Touch the touchscreen to wake it up.
NOTE: It may take several minutes to receive enough power to wake up the touchscreen.
6. When external low voltage power is no longer required, disconnect both cables, beginning with the black negative (-) cable.
7. On top of the low voltage battery, push the connector housing towards the electrical connector so that the electrical connector engages the low voltage battery.
8. On top of the low voltage battery, push down the locking tab that attaches the electrical connector to the connector housing.
9. Replace the maintenance panel by placing it back in its original location and pressing down until it is secure.
10. Close the hood.



Opening a Front Door with No Power

If Model X has no electrical power, the front doors open as usual using the interior door handles.

Opening a Rear Door with No Power

To open the falcon wing doors in the unlikely situation when Model X has no power, carefully remove the speaker grille from the door and pull the mechanical release cable down and towards the front of the vehicle. After the latch is released, manually lift up the door.



⚠ CAUTION: Manual door releases are designed to be used only in situations when Model X has no power. When Model X has power, use the button located at the top of the interior door handle.



Submerged Vehicle Guidance

Vehicle submersion can be caused by a flood or other extreme weather conditions. Tesla wants to ensure you have the resources should there be a risk of vehicle submersion or if your vehicle experiences submersion in water.

Review these recommendations to help prepare for a potential vehicle submersion, know how to handle a submerged vehicle, and find available resources.

Best Practices to Prepare for Potential Flooding

If a submersion event is in the forecast and it is safe for you to preemptively move your vehicle, Tesla recommends you attempt to move Model X to a location that is not at risk, or to higher ground. Keep in mind that charging infrastructure may be impacted, so Tesla recommends charging to 100% ahead of time.

However, if you are unable to move your vehicle to an area that is not at risk of flooding, consider the following best practices which may help prevent damage:

- Make sure to unplug the charger from your vehicle.
- Reduce the state of charge. This can be done by driving the vehicle ahead of time and leaving it unplugged, or by turning on climate controls or enabling **Keep Climate On** using your vehicle touchscreen or Tesla mobile app (see [Operating Climate Controls on page 149](#)). The intention is to have the charge level as low as possible if the vehicle becomes submerged.
- Change the air suspension (if equipped) and raise the vehicle height to **High** or **Very High** prior to leaving the vehicle.
- Lift the vehicle so that the high voltage Battery is above a potential flood line by raising it on jack stands, cylinder blocks, ramps, etc. Remember to enable **Jack Mode** with air suspension (if equipped) to avoid damage from self-leveling (see [Jacking and Lifting on page 197](#)).
- Leave Model X in a water-tight car cover, or similar product, specifically designed to protect vehicles from flooding.

Handling a Submerged Vehicle

Know what to do if your vehicle, whether it's an electric vehicle or internal combustion engine vehicle, has been exposed to prolonged submersion.

 **WARNING:** If you notice fire, smoke, audible popping/hissing or heating coming from your vehicle, step away and immediately contact your local first responders.

Follow these steps once the vehicle is no longer submerged and is safe to access:

1. Treat your vehicle as if it has been in an accident and contact your insurance company.

2. Do not attempt to operate the vehicle until an authorized shop has inspected it. If you are a Tesla vehicle owner, you can schedule your inspection with Tesla Service.
3. Safely tow the vehicle at least 15 meters from structures or other combustible materials such as other cars and personal property.
 - Tesla owners can request towing assistance from Tesla. See [Contacting Tesla Roadside Assistance on page 215](#) for more information.
 - Refer to [Instructions for Transporters on page 212](#) for information on how to safely tow or move your vehicle.



APP_w009 **Automatic Emergency Braking is unavailable** **Feature may be restored on next drive**

What this alert means:

The Automatic Emergency Braking feature is unavailable for the rest of your current drive. This alert does not specifically indicate any other braking functions or features are unavailable.

This alert may be present for several reasons. Other alerts may be present for conditions that also cause Automatic Emergency Braking to be unavailable.

What to do:

No action is typically required. Automatic Emergency Braking will usually be available again when you start your next drive.

If this alert persists across multiple drives, or occurs with increasing frequency over several drives, it is recommended that you schedule service at your earliest convenience.

For more information, see [Collision Avoidance Assist on page 138](#).

APP_w048 **Autopilot features temporarily unavailable** **Features may be restored on next drive**

What this alert means:

Autopilot features are currently unavailable on your vehicle. Depending on the configuration of your vehicle, Autopilot features that are disabled may include:

- Autosteer
- Traffic-Aware Cruise Control
- Automatic Emergency Braking
- Forward Collision Warning
- Lane Departure Warning

What to do:

This alert can be set for several reasons. Check for additional alerts that indicate the cause of this condition.

Typically, Autopilot features are restored on your next drive. If this alert persists across multiple drives, schedule service at your earliest convenience.

For more information and the full list of Autopilot features, see [About Autopilot on page 112](#).

APP_w207 **Autosteer temporarily unavailable**

What this alert means:

Autosteer is temporarily unavailable. This could be a temporary condition caused by an external factor, such as:

- Missing or faded lane markers.
- Narrow or winding roads.
- Poor visibility due to rain, snow, fog, or other weather.



Troubleshooting Alerts

- Extremely hot or cold temperatures.
- Bright light due to other vehicle headlights, direct sunlight, or other light sources.

This alert will also be present if you exceeded the maximum speed limit for Autosteer with Autosteer active. In this case, Autosteer will not be available for the rest of your current drive.

What to do:

Continue to your destination. If Autosteer is not available by the time you reach your destination, and remains unavailable during your next planned drive, check for the following:

- Damage or obstruction caused by mud, ice, snow, or other environmental factors
- Obstruction caused by an object mounted on the vehicle, like a bike rack
- Obstructions caused by adding paint or adhesive products like wraps, stickers, or rubber coatings to your vehicle
- A damaged or misaligned bumper

If there are no obvious obstructions, or if you find damage to the vehicle, schedule service at your convenience. Your vehicle is OK to drive in the meantime.

For more information, see [#unique_73](#) on page .

APP_w218

Autosteer speed limit exceeded Take control of steering wheel

What this alert means:

Autosteer is unavailable because your vehicle has exceeded the maximum speed limit for this driver assistance feature.

What to do:

Take immediate control of the steering wheel and maintain control until you reach your destination.

In most cases, Autosteer will not be available for the rest of your current drive. To reset it, bring the vehicle to a complete stop and shift into Park. When you shift into Drive to travel to your next destination, Autosteer should be available again.

NOTE: If this alert becomes active while you are driving in Germany, Autosteer should be available again once your vehicle is traveling below the Autosteer speed limit.

If Autosteer is not available during your next drive, and remains unavailable throughout subsequent drives, schedule service at your convenience. Your vehicle is OK to drive in the meantime.

For more information, see [#unique_73](#) on page .

APP_w221

Cruise control unavailable Reduced front radar visibility

What this alert means:

Traffic-Aware Cruise Control and Autosteer are unavailable because the radar located in the front bumper area of your vehicle has no or low visibility.

This could be a temporary obstruction caused by factors like snow, ice, dirt, or mud.

What to do:

Continue to your destination. Your vehicle is OK to drive. Traffic-Aware Cruise Control and Autosteer will remain unavailable as long as the radar lacks adequate visibility.



If the alert persists throughout your drive, examine the front bumper before your next planned drive and attempt to clear any obstruction. See [Cleaning a Camera on page 191](#) for more information on clearing dirt or debris from that area of the vehicle.

If this alert persists throughout subsequent drives but no obstruction is visible on the front bumper where the radar is located, schedule service at your earliest convenience. Your vehicle is OK to drive in the meantime.

APP_w222

Cruise control unavailable

Reduced front camera visibility

What this alert means:

Traffic-Aware Cruise Control and Autosteer are unavailable because one or more of the front cameras in your vehicle is blocked or blinded by external conditions.

Traffic-Aware Cruise Control and Autosteer will remain unavailable while a front camera lacks adequate visibility. Cameras may have limited or no visibility due to:

- Dirt or debris on the camera surface.
- Environmental conditions like rain, fog, snow, or dew.
- Bright sunlight or glare from another light source.
- Low or limited light conditions, including unlit or poorly lit roadways at night.
- Condensation (water droplets or mist) on the camera surface.
- Monotonous environmental features, including tunnel walls or highway dividers.

What to do:

Continue to your destination. Your vehicle is OK to drive.

This is often a temporary issue that clears up on its own. If the alert does not clear by the end of your drive:

- Inspect and clean the front camera area at the top center of the windshield before your next planned drive.
- Check the camera surface for condensation, dirt, or other debris and attempt to clear any obstruction.

See [Cleaning a Camera on page 191](#) for more information on clearing dirt or debris from that area of the vehicle.

Although condensation on the inside of the front camera enclosure cannot be wiped clean, you can usually clear it quicker by following these steps:

1. Pre-condition the cabin with the temperature set to High and A/C turned ON.
2. Turn on the front windshield defroster.

If this alert persists throughout subsequent drives but no front camera obstruction is visible, schedule service at your earliest convenience. Your vehicle is OK to drive in the meantime.

APP_w224

Cruise control unavailable

Continue driving to allow cameras to calibrate

What this alert means:

Traffic-Aware Cruise Control and Autosteer are unavailable because the cameras on your vehicle are not fully calibrated.

Your vehicle must maneuver with great precision when features like Traffic-Aware Cruise Control and Autosteer are active. Before these features can be used for the first time, the cameras must complete an initial self-calibration. Occasionally, one or more cameras can become uncalibrated.

**What to do:**

Continue to your destination. Your vehicle is OK to drive.

Traffic-Aware Cruise Control and Autosteer will remain unavailable until camera calibration is complete.

When calibration is complete, Traffic-Aware Cruise Control and Autosteer should be available.

For your convenience, a calibration progress indicator is displayed on the touchscreen. Calibration typically completes after your vehicle has driven 20–25 miles (32–40 km), but the distance varies depending on road and environmental conditions. For example, driving on a straight road with highly visible lane markings helps the cameras calibrate quicker.

If the alert persists and camera calibration has not completed after your vehicle has driven 100 miles (160 km) or more, or Traffic-Aware Cruise Control and Autosteer remain unavailable despite successful camera calibration, schedule service at your earliest convenience. Your vehicle is OK to drive in the meantime.

APP_w304**Camera blocked or blinded****Clean camera or wait for it to regain visibility****What this alert means:**

One or more of the vehicle cameras has limited visibility, or no visibility at all, due to external conditions. When the cameras on your vehicle cannot provide accurate visual information, some or all Autopilot features may be temporarily unavailable.

Cameras may have limited or no visibility due to:

- Dirt or debris on the camera surface.
- Environmental conditions like rain, fog, snow, or dew.
- Bright sunlight or glare from another light source.
- Low or limited light conditions, including unlit or poorly lit roadways at night.
- Condensation (water droplets or mist) on the camera surface.
- Monotonous environmental features, including tunnel walls or highway dividers.

What to do:

Continue to your destination. Your vehicle is OK to drive. This is often a temporary issue that will be resolved when condensation evaporates, or when a particular environmental condition or feature is no longer present.

If the alert does not clear by the time you reach your destination, check camera surfaces for condensation, dirt, or other debris. For camera locations, see [Cameras on page 19](#).

Clean the cameras as necessary before your next planned drive. For recommended cleaning procedures, see [Cleaning a Camera on page 191](#).

If you continue to see this alert after cleaning the cameras, check the inside surfaces of the door pillar camera enclosures for condensation. Although condensation inside the camera enclosures cannot be wiped clean, you can usually clear it faster by following these steps:

1. Precondition the cabin by turning Climate ON, setting temperature to High, and making sure A/C is ON.
2. Turn on the front windshield defroster.
3. Direct the air vents toward the door pillar cameras.

For more information on clearing condensation from camera enclosures, see [Cleaning a Camera on page 191](#).

If the alert does not clear by the end of your next planned drive, despite cleaning the indicated camera(s) and following recommended steps to clear condensation, schedule service at your next convenient opportunity. Your vehicle is OK to drive in the meantime.



BMS_u006

Vehicle shutting down - PULL OVER SAFELY Battery charge level too low

What this alert means:

Your vehicle has detected that the high voltage battery does not have enough energy remaining to support driving.

Your vehicle will be unable to drive or continue driving until charged.

If this alert is present while you are driving, your vehicle needs to shut down. A separate vehicle alert should be present to indicate this condition. It is also possible your vehicle may shut down unexpectedly.

If this alert is present when your vehicle is parked, you may be unable to drive.

This alert is usually present because your vehicle's high voltage battery charge level has been reduced through normal operation.

What to do:

Charge your vehicle immediately. Charging your vehicle should restore your vehicle's ability to drive.

If this alert occurs during subsequent drives, despite a displayed battery charge level of 5% or higher, schedule service at your earliest convenience.

For more information on the high voltage battery, see [High Voltage Battery Information on page 170](#).

For more information on charging, see [Charging Instructions on page 172](#).

BMS_u018

Maximum battery charge level reduced OK to drive - Schedule service

What this alert means:

Your vehicle has detected a condition internal to the high voltage battery that is limiting the battery's performance. As a result, maximum charge level and range are reduced. Service is required to restore full performance.

What to do:

If this alert persists, schedule service soon. Without service, your vehicle's maximum charge level and range will remain limited.

Your vehicle is OK to drive and charge.

For more information on the high voltage battery, see [High Voltage Battery Information on page 170](#).

BMS_u030

Charging adapter has electric arc flash hazard Use different charging equipment

What this alert means:

Charging is unavailable because your vehicle has detected an electric arc flash hazard in the third-party charging adapter used to connect a Combined Charging System (CCS) charge handle to your vehicle's charge port.

An electric arc flash can occur if you attempt to unplug **while actively charging with the third-party charging adapter**, and an electric arc flash can cause serious bodily injury and/or property damage.

What to do:



Troubleshooting Alerts

Follow the steps below to mitigate this risk:

- Make sure charging is completely stopped.
 1. Use your vehicle touchscreen to confirm charging has stopped, or to stop charging if necessary.
 2. Use the charging station display and controls to confirm charging has stopped, or to end any active charging session.
- Make sure no flashing green or blue light (LED) is visible on your vehicle's charge port.
- Unplug the charging adapter from your vehicle's charge port.
- Confirm again that the charging station indicates no active charging session.
- Unplug the charging adapter from the charge handle.

Use different charging equipment to charge your vehicle. For more information on charging, see [Charging Instructions on page 172](#).

You can also try charging your vehicle using a Tesla Supercharger or Destination Charging location, all of which can be located through the map on your vehicle's touchscreen display. See [Maps and Navigation on page 158](#) for more details.

BMS_u031

Battery fuse requires replacement soon

OK to drive - Schedule service

What this alert means:

A fuse in your vehicle's high voltage battery is very near the end of its lifetime and requires replacement.

What to do:

It is recommended that you schedule service as soon as possible to have the high voltage battery fuse replaced.

Your vehicle is OK to drive in the meantime. However, you may notice reduced speed and acceleration while driving.

For more information on the high voltage battery system, see [High Voltage Battery Information](#).

BMS_u032

Battery fuse replacement required

OK to drive - Schedule service

What this alert means:

A fuse in your vehicle's high voltage battery is very near the end of its lifetime and requires replacement.

What to do:

It is recommended that you schedule service as soon as possible to have the high voltage battery fuse replaced.

Your vehicle is OK to drive in the meantime. However, you may notice reduced speed and acceleration while driving.

For more information on the high voltage battery system, see [High Voltage Battery Information](#).

BMS_w176

Battery fuse replacement required

OK to drive - Schedule service immediately

What this alert means:

A fuse in your vehicle's high voltage battery is at the end of its lifetime and requires immediate replacement.

What to do:



It is recommended that you schedule service immediately to have the high voltage battery fuse replaced.

Continue to your immediate destination. Your vehicle is OK to drive. However, you may notice reduced speed and acceleration while driving.

For more information on the high voltage battery system, see [High Voltage Battery Information](#).

BMS_w179

Vehicle may not restart Service is required

What this alert means:

The battery management system on your vehicle has detected that the high voltage battery smart fuse needs to be replaced.

If this alert is present while you are driving, your vehicle will enter a limited power mode to prevent any potential damage to the battery pack and drive power will be reduced until the condition has been resolved.

What to do:

It is recommended that you schedule service at your earliest convenience. The replacement procedure for the smart fuse is minor and should restore your vehicle's full performance once completed.

Without service, your vehicle will no longer start, charge, or support the low voltage system.

For more information on the high voltage battery system, see [High Voltage Battery Information](#).

CC_f001

Unable to charge - Insufficient grounding Proper wiring or outlet grounding must be verified

What this alert means:

No ground connection detected in the Wall Connector.

What to do:

Have the Wall Connector inspected by an electrician to make sure it is properly grounded. Your electrician should ensure there is proper grounding at your circuit breaker or power distribution box and also ensure that appropriate connections are made to the Wall Connector.

For more information, see the [installation guide](#) for your Wall Connector.

CC_f002

Unable to charge - Insufficient grounding Disconnect and retry or use different equipment

What this alert means:

Ground fault. Current is leaking through an unsafe path. Possible Line to ground or Neutral to ground fault.

What to do:

Try charging again by disconnecting the Wall Connector from the vehicle and reconnecting. If the issue persists, turn OFF the circuit breaker servicing the Wall Connector, wait 10 seconds, turn the circuit breaker ON again, then try reconnecting the Wall Connector to the vehicle. If the issue persists, consult your electrician or contact Tesla.

For more information, see the [installation guide](#) for your Wall Connector.



CC_f003

Unable to charge - Wall Connector GFCI tripped Disconnect and retry or use different equipment

What this alert means:

Ground fault. Current is leaking through an unsafe path. Possible Line to ground or Neutral to ground fault.

What to do:

Try charging again by disconnecting the Wall Connector from the vehicle and reconnecting. If the issue persists, turn OFF the circuit breaker servicing the Wall Connector, wait 10 seconds, turn the circuit breaker ON again, then try reconnecting the Wall Connector to the vehicle. If the issue persists, consult your electrician or contact Tesla.

For more information, see the [installation guide](#) for your Wall Connector.

CC_f004

Unable to charge - Wall Connector issue Wall Connector needs service

What this alert means:

Wall Connector hardware issue. Possible issues include:

1. Contactor not working
2. Self-test of internal ground fault monitoring circuit failed
3. Thermal sensor disconnected
4. Other hardware component issues

What to do:

An internal issue was detected by the Wall Connector.

1. Try charging again by disconnecting the Wall Connector from the vehicle and reconnecting.
2. If the issue persists, turn OFF the circuit breaker for the Wall Connector, wait 10 seconds, and turn the circuit breaker ON again. Then try reconnecting the Wall Connector to the vehicle.
3. If the issue persists, have an electrician make sure all wires are properly connected and torqued according to the instructions in the Wall Connector Installation Manual.
4. Once your electrician has completed all work and restored power to the Wall Connector, try charging again by reconnecting the Wall Connector to the vehicle.
5. If the issue persists, the Wall Connector requires service.

For more information, see the [installation guide](#) for your Wall Connector.

CC_f005

Unable to charge - Wall Connector GFCI tripped Disconnect and retry or use different equipment

What this alert means:

Ground fault. Current is leaking through an unsafe path. Possible Line to ground or Neutral to ground fault.

What to do:



Try charging again by disconnecting the Wall Connector from the vehicle and reconnecting. If the issue persists, turn OFF the circuit breaker servicing the Wall Connector, wait 10 seconds, turn the circuit breaker ON again, then try reconnecting the Wall Connector to the vehicle. If the issue persists, consult your electrician or contact Tesla.

For more information, see the [installation guide](#) for your Wall Connector.

CC_f006

Unable to charge - Wall Connector overcurrent Disconnect and retry or use different equipment

What this alert means:

Over current protection.

What to do:

Reduce the vehicle's charge current setting. If the issue persists, service is required.

For more information, see the [installation guide](#) for your Wall Connector.

CC_f007

Unable to charge - Input voltage too high Voltage must be within Wall Connector rating

What this alert means:

Over or under voltage protection.

What to do:

Consult your electrician to ensure appropriate voltage on the circuit breaker that services the Wall Connector.

For more information, see the [installation guide](#) for your Wall Connector.

CC_f008

Unable to charge - Input voltage too low Voltage must be within Wall Connector rating

What this alert means:

Over or under voltage protection.

What to do:

Consult your electrician to ensure appropriate voltage on the circuit breaker that services the Wall Connector.

For more information, see the [installation guide](#) for your Wall Connector.

CC_f009

Unable to charge - Input wired incorrectly Input wiring to Wall Connector must be corrected

What this alert means:

Input miswired: possibly Line and Neutral are swapped.

What to do:



Troubleshooting Alerts

The wiring between the wall power and the Wall Connector has been incorrectly installed. Consult your electrician.

For more information, see the [installation guide](#) for your Wall Connector.

CC_f010

Unable to charge - Wall Connector issue Wall Connector needs service

What this alert means:

Wall Connector hardware issue. Possible issues include:

1. Contactor not working
2. Self-test of internal ground fault monitoring circuit failed
3. Thermal sensor disconnected
4. Other hardware component issues

What to do:

An internal issue was detected by the Wall Connector.

1. Try charging again by disconnecting the Wall Connector from the vehicle and reconnecting.
2. If the issue persists, turn OFF the circuit breaker for the Wall Connector, wait 10 seconds, and turn the circuit breaker ON again. Then try reconnecting the Wall Connector to the vehicle.
3. If the issue persists, have an electrician make sure all wires are properly connected and torqued according to the instructions in the Wall Connector Installation Manual.
4. Once your electrician has completed all work and restored power to the Wall Connector, try charging again by reconnecting the Wall Connector to the vehicle.
5. If the issue persists, the Wall Connector requires service.

For more information, see the [installation guide](#) for your Wall Connector.

CC_f011

Unable to charge - Wall Connector too hot Let Wall Connector cool and try again

What this alert means:

Over temperature protection (latchoff).

What to do:

Make sure the Wall Connector is not covered by anything and that there is no heat source nearby. If the problem persists in normal ambient temperatures (under 38°C), service is required.

For more information, see the [installation guide](#) for your Wall Connector.

CC_f012

Unable to charge - Wall connection too hot Outlet or Wall Connector wiring must be checked

High temperature detected by Wall Connector alerts indicate the building connection to the Wall Connector is getting too warm, so charging has stopped to protect the wiring and Wall Connector.

This is not typically an issue with your vehicle or your Wall Connector, but rather an issue with the building wiring. This may be caused by a loose building wiring connection to the Wall Connector and can be fixed quickly by an electrician.



To regain normal charge operation, try the following steps.

If the Wall Connector is plugged into a wall outlet, make sure:

- The plug is fully inserted into the receptacle / outlet
- The plug / outlet area is not blocked or covered by anything
- There is no heat source nearby

If the issue persists or the Wall Connector is hard-wired, contact an electrician to inspect the building wiring connection to the Wall Connector. They should make sure that all wires are properly connected and torqued according to the installation guide for the Wall Connector.

For more information, see the [installation guide](#) for your Wall Connector.

CC_f013

Unable to charge - Charge handle too hot Check charge handle or charge port for debris

What this alert means:

Over temperature protection (latchoff).

What to do:

Make sure the connector is fully inserted into the charge inlet in the vehicle's charging port, is not covered by anything, and there is no heat source nearby. If the issue persists in normal ambient temperatures (under 38°C), service is required.

For more information, see the [installation guide](#) for your Wall Connector.

CC_f014

Unable to charge - Wall Connector issue Wall Connector needs service

What this alert means:

Wall Connector hardware issue. Possible issues include:

1. Contactor not working
2. Self-test of internal ground fault monitoring circuit failed
3. Thermal sensor disconnected
4. Other hardware component issues

What to do:

An internal issue was detected by the Wall Connector.

1. Try charging again by disconnecting the Wall Connector from the vehicle and reconnecting.
2. If the issue persists, turn OFF the circuit breaker for the Wall Connector, wait 10 seconds, and turn the circuit breaker ON again. Then try reconnecting the Wall Connector to the vehicle.
3. If the issue persists, have an electrician make sure all wires are properly connected and torqued according to the instructions in the Wall Connector Installation Manual.
4. Once your electrician has completed all work and restored power to the Wall Connector, try charging again by reconnecting the Wall Connector to the vehicle.
5. If the issue persists, the Wall Connector requires service.

For more information, see the [installation guide](#) for your Wall Connector.



CC_f015

Unable to charge - Vehicle connection issue **Insert charge handle fully into charge port**

What this alert means:

A communication error occurred between the Wall Connector and the vehicle.

What to do:

Try charging again by disconnecting the Wall Connector from the vehicle and reconnecting.

1. If the issue persists, turn OFF the circuit breaker servicing the Wall Connector, wait 10 seconds, turn the circuit breaker ON again, then try reconnecting the Wall Connector to the vehicle.
2. If the issue persists and other charging equipment is available, plug the vehicle into another Wall Connector or a Mobile Connector to determine if the vehicle is able to communicate with other charging equipment.
3. If the issue persists, service is required.

For more information, see the [installation guide](#) for your Wall Connector.

CC_f016

Unable to charge - Vehicle connection issue **Insert charge handle fully into charge port**

What this alert means:

A communication error occurred between the Wall Connector and the vehicle.

What to do:

Try charging again by disconnecting the Wall Connector from the vehicle and reconnecting.

1. If the issue persists, turn OFF the circuit breaker servicing the Wall Connector, wait 10 seconds, turn the circuit breaker ON again, then try reconnecting the Wall Connector to the vehicle.
2. If the issue persists and other charging equipment is available, plug the vehicle into another Wall Connector or a Mobile Connector to determine if the vehicle is able to communicate with other charging equipment.
3. If the issue persists, service is required.

For more information, see the [installation guide](#) for your Wall Connector.

CC_f017

Unable to charge - Vehicle connection issue **Insert charge handle fully into charge port**

What this alert means:

A communication error occurred between the Wall Connector and the vehicle.

What to do:

Try charging again by disconnecting the Wall Connector from the vehicle and reconnecting.

1. If the issue persists, turn OFF the circuit breaker servicing the Wall Connector, wait 10 seconds, turn the circuit breaker ON again, then try reconnecting the Wall Connector to the vehicle.
2. If the issue persists and other charging equipment is available, plug the vehicle into another Wall Connector or a Mobile Connector to determine if the vehicle is able to communicate with other charging equipment.



3. If the issue persists, service is required.

For more information, see the [installation guide](#) for your Wall Connector.

CC_f018

Unable to charge - Vehicle connection issue

Insert charge handle fully into charge port

What this alert means:

A communication error occurred between the Wall Connector and the vehicle.

What to do:

Try charging again by disconnecting the Wall Connector from the vehicle and reconnecting.

1. If the issue persists, turn OFF the circuit breaker servicing the Wall Connector, wait 10 seconds, turn the circuit breaker ON again, then try reconnecting the Wall Connector to the vehicle.
2. If the issue persists and other charging equipment is available, plug the vehicle into another Wall Connector or a Mobile Connector to determine if the vehicle is able to communicate with other charging equipment.
3. If the issue persists, service is required.

For more information, see the [installation guide](#) for your Wall Connector.

CC_f019

Unable to charge - Vehicle connection issue

Insert charge handle fully into charge port

What this alert means:

A communication error occurred between the Wall Connector and the vehicle.

What to do:

Try charging again by disconnecting the Wall Connector from the vehicle and reconnecting.

1. If the issue persists, turn OFF the circuit breaker servicing the Wall Connector, wait 10 seconds, turn the circuit breaker ON again, then try reconnecting the Wall Connector to the vehicle.
2. If the issue persists and other charging equipment is available, plug the vehicle into another Wall Connector or a Mobile Connector to determine if the vehicle is able to communicate with other charging equipment.
3. If the issue persists, service is required.

For more information, see the [installation guide](#) for your Wall Connector.

CC_f020

Unable to charge - Wall Connector issue

Wall Connector needs service

What this alert means:

Wall Connector hardware issue. Possible issues include:

1. Contactor not working
2. Self-test of internal ground fault monitoring circuit failed
3. Thermal sensor disconnected



4. Other hardware component issues

What to do:

An internal issue was detected by the Wall Connector.

1. Try charging again by disconnecting the Wall Connector from the vehicle and reconnecting.
2. If the issue persists, turn OFF the circuit breaker for the Wall Connector, wait 10 seconds, and turn the circuit breaker ON again. Then try reconnecting the Wall Connector to the vehicle.
3. If the issue persists, have an electrician make sure all wires are properly connected and torqued according to the instructions in the Wall Connector Installation Manual.
4. Once your electrician has completed all work and restored power to the Wall Connector, try charging again by reconnecting the Wall Connector to the vehicle.
5. If the issue persists, the Wall Connector requires service.

For more information, see the [installation guide](#) for your Wall Connector.

CC_f021

Unable to charge - No primary Wall Connector Check that primary unit is powered and available

What this alert means:

Load sharing (circuit breaker sharing) network: Need one (and only one) Wall Connector set as primary.

What to do:

Only one Wall Connector can be set to a primary configuration. Have your electrician confirm:

1. Only one of the Wall Connectors is set as primary.
2. All other Wall Connectors linked to the primary unit are set to paired position (position F).

For more information, see the [installation guide](#) for your Wall Connector.

CC_f022

Unable to charge - More than 1 primary unit Ensure only 1 Wall Connector is set as primary

What this alert means:

Load sharing (circuit breaker sharing) network: Need one (and only one) Wall Connector set as primary.

What to do:

Only one Wall Connector can be set to a primary configuration. Have your electrician confirm:

1. Only one of the Wall Connectors is set as primary.
2. All other Wall Connectors linked to the primary unit are set to paired position (position F).

For more information, see the [installation guide](#) for your Wall Connector.



CC_f023

Unable to charge - Too many Wall Connectors Ensure no more than 3 units paired with primary

What this alert means:

Load sharing (circuit breaker sharing) network: More than three Wall Connectors are paired with the same primary unit.

What to do:

Consult your electrician to have one or more paired Wall Connectors moved to a different circuit and disconnected (unpaired) from this load sharing (circuit breaker sharing) network.

For more information, see the [installation guide](#) for your Wall Connector.

CC_f024

Unable to charge - Low Wall Connector current Primary unit current setting must be increased

What this alert means:

Incorrect rotary switch setting.

What to do:

Have your electrician adjust the Wall Connector's internal rotary switch to a valid operating current setting. They should first make sure there is no power to the Wall Connector. The correlation between switch setting and current should be printed on the inside of the Wall Connector. Your electrician should also refer to the Set the Operating Current section in the Wall Connector Installation Manual.

If the Wall Connector is set up for load sharing (circuit breaker sharing) and paired with other Wall Connectors, the rotary switch of the primary unit must be set to an operating current setting that allows each paired Wall Connector to receive at least 6A of charge current.

Example: Three Wall Connectors are paired for load sharing. The primary unit needs to be set to a current of at least $3 * 6A = 18A$ or greater.

For more information, see the [installation guide](#) for your Wall Connector.

CC_f025

Unable to charge - Wall Connector issue Wall Connector needs service

What this alert means:

Wall Connector hardware issue. Possible issues include:

1. Contactor not working
2. Self-test of internal ground fault monitoring circuit failed
3. Thermal sensor disconnected
4. Other hardware component issues

What to do:

An internal issue was detected by the Wall Connector.

1. Try charging again by disconnecting the Wall Connector from the vehicle and reconnecting.



Troubleshooting Alerts

2. If the issue persists, turn OFF the circuit breaker for the Wall Connector, wait 10 seconds, and turn the circuit breaker ON again. Then try reconnecting the Wall Connector to the vehicle.
3. If the issue persists, have an electrician make sure all wires are properly connected and torqued according to the instructions in the Wall Connector Installation Manual.
4. Once your electrician has completed all work and restored power to the Wall Connector, try charging again by reconnecting the Wall Connector to the vehicle.
5. If the issue persists, the Wall Connector requires service.

For more information, see the [installation guide](#) for your Wall Connector.

CC_f026

Unable to charge - Wall Connector issue Wall Connector needs service

What this alert means:

Wall Connector hardware issue. Possible issues include:

1. Contactor not working
2. Self-test of internal ground fault monitoring circuit failed
3. Thermal sensor disconnected
4. Other hardware component issues

What to do:

An internal issue was detected by the Wall Connector.

1. Try charging again by disconnecting the Wall Connector from the vehicle and reconnecting.
2. If the issue persists, turn OFF the circuit breaker for the Wall Connector, wait 10 seconds, and turn the circuit breaker ON again. Then try reconnecting the Wall Connector to the vehicle.
3. If the issue persists, have an electrician make sure all wires are properly connected and torqued according to the instructions in the Wall Connector Installation Manual.
4. Once your electrician has completed all work and restored power to the Wall Connector, try charging again by reconnecting the Wall Connector to the vehicle.
5. If the issue persists, the Wall Connector requires service.

For more information, see the [installation guide](#) for your Wall Connector.

CC_f027

Unable to charge - Wall Connector issue Wall Connector needs service

What this alert means:

Wall Connector hardware issue. Possible issues include:

1. Contactor not working
2. Self-test of internal ground fault monitoring circuit failed
3. Thermal sensor disconnected
4. Other hardware component issues

What to do:



An internal issue was detected by the Wall Connector.

1. Try charging again by disconnecting the Wall Connector from the vehicle and reconnecting.
2. If the issue persists, turn OFF the circuit breaker for the Wall Connector, wait 10 seconds, and turn the circuit breaker ON again. Then try reconnecting the Wall Connector to the vehicle.
3. If the issue persists, have an electrician make sure all wires are properly connected and torqued according to the instructions in the Wall Connector Installation Manual.
4. Once your electrician has completed all work and restored power to the Wall Connector, try charging again by reconnecting the Wall Connector to the vehicle.
5. If the issue persists, the Wall Connector requires service.

For more information, see the [installation guide](#) for your Wall Connector.

CC_f028

Unable to charge - Incorrect switch setting Wall Connector rotary switch must be adjusted

What this alert means:

Incorrect rotary switch setting.

What to do:

Have your electrician adjust the Wall Connector's internal rotary switch to a valid operating current setting. They should first make sure there is no power to the Wall Connector. The correlation between switch setting and current should be printed on the inside of the Wall Connector. Your electrician should also refer to the Set the Operating Current section in the Wall Connector Installation Manual.

If the Wall Connector is set up for load sharing (circuit breaker sharing) and paired with other Wall Connectors, the rotary switch of the primary unit must be set to an operating current setting that allows each paired Wall Connector to receive at least 6A of charge current.

Example: Three Wall Connectors are paired for load sharing. The primary unit needs to be set to a current of at least $3 * 6A = 18A$ or greater.

For more information, see the [installation guide](#) for your Wall Connector.

CC_f029

Unable to charge - Vehicle connection issue Insert charge handle fully into charge port

What this alert means:

A communication error occurred between the Wall Connector and the vehicle.

What to do:

Try charging again by disconnecting the Wall Connector from the vehicle and reconnecting.

1. If the issue persists, turn OFF the circuit breaker servicing the Wall Connector, wait 10 seconds, turn the circuit breaker ON again, then try reconnecting the Wall Connector to the vehicle.
2. If the issue persists and other charging equipment is available, plug the vehicle into another Wall Connector or a Mobile Connector to determine if the vehicle is able to communicate with other charging equipment.
3. If the issue persists, service is required.

For more information, see the [installation guide](#) for your Wall Connector.



CC_f030

Unable to charge - Primary / paired unit mismatch Wall Connector current ratings must match

What this alert means:

Load sharing (circuit breaker sharing) network: The paired Wall Connectors have different maximum current capabilities.

What to do:

Only Wall Connectors with the same maximum current capabilities can be paired in a load sharing (circuit breaker sharing) network. Have your electrician inspect the type labels on the Wall Connectors and make sure the current capabilities match. It is further recommended that your electrician only pair Wall Connectors with the same part number, as an easy way to make sure paired units are compatible.

For more information, see the [installation guide](#) for your Wall Connector.

CC_f041

Charge rate reduced - Wall connection hot Outlet or Wall Connector wiring must be checked

What this alert means:

High temperature detected by Wall Connector alerts indicate the building connection to the Wall Connector is getting too warm, so charging has been slowed to protect the wiring and Wall Connector.

This is not typically an issue with your vehicle or your Wall Connector, but rather an issue with the building wiring. This may be caused by a loose building wiring connection to the Wall Connector and can be fixed quickly by an electrician.

What to do:

Contact an electrician to inspect the building wiring connection to the Wall Connector. They should make sure that all wires are properly connected and torqued according to the installation guide for the Wall Connector.

For more information, see the [installation guide](#) for your Wall Connector.

CHG_f035

Charging equipment communication error Try again or try different equipment

What this alert means:

Your vehicle is unable to charge because it cannot communicate effectively with the external charging equipment. It cannot sense a valid control pilot signal coming from the charging equipment.

This alert is usually specific to external charging equipment and power sources and does not typically indicate an issue with your vehicle that can be resolved by scheduling service.

What to do:

First, confirm the lack of effective communication is caused by the external charging equipment rather than an issue with your vehicle. This is usually the case.

Try charging the vehicle using different external charging equipment (including charge cable, charging station, or charging stall).

- If the vehicle begins charging, the issue was likely with the equipment.
- If the vehicle still does not charge, the issue may be with the vehicle.



If the issue is suspected to be with the vehicle, inspect the charge port inlet and the charge cable connector for any obstructions, such as debris, moisture, and/or foreign objects. Make sure any charge port inlet obstruction has been removed and any moisture has been allowed to dry, then try re-inserting the cable into the charge port.

You can also try charging your vehicle using a Tesla Supercharger or Destination Charging location, all of which can be located through the map on your vehicle's touchscreen display. See [Maps and Navigation on page 158](#) for more details.

For more information on troubleshooting Mobile Connector or Wall Connector status lights, refer to the product's Owner's Manual at [Charging & Adapter Product Guides](#).

For more information on charging, see [Charging Instructions on page 172](#).

CHG_f083

Cannot charge - Poor grid power quality possible Retry / Try other charge location or Supercharging

What this alert means:

Power has been lost during charging. This could result from the charging equipment losing power from the source (for example, a wall outlet) or from an issue with the charging equipment.

What to do:

This alert is often accompanied by other alerts that can help you identify and troubleshoot the issue. Start by investigating any other displayed alerts that relate to charging issues.

Alternatively, you can check Mobile Connector or Wall Connector status lights to confirm power to the device, and also refer to the product owner's manual for troubleshooting information based on blink codes. If using other (non-Tesla) external charging equipment, check for a display or other user interface that provides troubleshooting help.

If there is clearly no power to the charging equipment, check the circuit breaker for the wall outlet / Wall Connector to make sure it has not tripped.

Further troubleshooting tips based on equipment type:

- If using a Mobile Connector, try charging the vehicle with a different wall outlet.
 - If the vehicle starts to charge, the issue was likely with the original wall outlet.
 - If the vehicle still does not charge, the issue may be with the Mobile Connector.
- If using a Wall Connector, try charging the vehicle with different charging equipment like a Mobile Connector powered by a separate wall outlet.
 - If the vehicle starts to charge, the issue was likely with the Wall Connector.

If the issue is with the original wall outlet or the Wall Connector, contact an electrician to inspect the wiring connection.

This alert is usually specific to external charging equipment and power sources and does not typically indicate an issue with your vehicle that can be resolved by scheduling service.

You can also try charging your vehicle using a Tesla Supercharger or Destination Charging location, all of which can be located through the map on your vehicle's touchscreen display. See [Maps and Navigation on page 158](#) for more details.

For more information on troubleshooting Mobile Connector or Wall Connector status lights, refer to the product's Owner's Manual at [Charging & Adapter Product Guides](#).

CHG_f091

Charging equipment not recognized Try again or try different equipment

What this alert means:



Troubleshooting Alerts

The charge port is unable to detect whether a charge cable is inserted, or the type of charge cable connected.

This alert is usually specific to external charging equipment and power sources and does not typically indicate an issue with your vehicle that can be resolved by scheduling service.

What to do:

If this alert appears while a charge cable **is** connected, determine whether the issue is caused by the charging equipment or the vehicle. Try charging the vehicle using different external charging equipment (including charge cable, charging station, or charging stall).

- If the vehicle begins charging, the issue was likely with the equipment.
- If the vehicle still does not charge, the issue may be with the vehicle.

If this alert appears while a charge cable is **not** connected or if the issue is suspected to be with the vehicle, inspect the charge port inlet and the charge cable connector for any obstructions, such as debris, moisture, and/or foreign objects. Make sure any charge port inlet obstruction has been removed and any moisture has been allowed to dry, then try re-inserting the cable into the charge port.

You can also try charging your vehicle using a Tesla Supercharger or Destination Charging location, all of which can be located through the map on your vehicle's touchscreen display. See [Maps and Navigation on page 158](#) for more details.

For more information on troubleshooting Mobile Connector or Wall Connector status lights, refer to the product's Owner's Manual at [Charging & Adapter Product Guides](#).

For more information on charging, see [Charging Instructions on page 172](#).

CHGS_f083

Cannot charge - Poor grid power quality possible Retry / Try other charge location or Supercharging

What this alert means:

Power has been lost during charging. This could result from the charging equipment losing power from the source (for example, a wall outlet) or from an issue with the charging equipment.

What to do:

This alert is often accompanied by other alerts that can help you identify and troubleshoot the issue. Start by investigating any other displayed alerts that relate to charging issues.

Alternatively, you can check Mobile Connector or Wall Connector status lights to confirm power to the device, and also refer to the product owner's manual for troubleshooting information based on blink codes. If using other (non-Tesla) external charging equipment, check for a display or other user interface that provides troubleshooting help.

If there is clearly no power to the charging equipment, check the circuit breaker for the wall outlet / Wall Connector to make sure it has not tripped.

Further troubleshooting tips based on equipment type:

- If using a Mobile Connector, try charging the vehicle with a different wall outlet.
 - If the vehicle starts to charge, the issue was likely with the original wall outlet.
 - If the vehicle still does not charge, the issue may be with the Mobile Connector.
- If using a Wall Connector, try charging the vehicle with different charging equipment like a Mobile Connector powered by a separate wall outlet.
 - If the vehicle starts to charge, the issue was likely with the Wall Connector.

If the issue is with the original wall outlet or the Wall Connector, contact an electrician to inspect the wiring connection.



This alert is usually specific to external charging equipment and power sources and does not typically indicate an issue with your vehicle that can be resolved by scheduling service.

You can also try charging your vehicle using a Tesla Supercharger or Destination Charging location, all of which can be located through the map on your vehicle's touchscreen display. See [Maps and Navigation on page 158](#) for more details.

For more information on troubleshooting Mobile Connector or Wall Connector status lights, refer to the product's Owner's Manual at [Charging & Adapter Product Guides](#).

CHG_u001

Charge rate reduced - Unexpected voltage drop

Remove extension cords / Have wiring inspected

What this alert means:

Charging speed has been reduced because the onboard charger in your vehicle has detected a large voltage drop during charging.

Likely causes of this issue include:

- Problems with the building wiring and/or the wall outlet.
- An extension cord or other wiring that cannot support the requested charge current.

This issue can also result from turning on electric devices that draw a lot of power from the same branch circuit while the vehicle is charging.

What to do:

If this issue has occurred multiple times at your normal charging location, contact an electrician to inspect the electrical installation. They should check the following:

- Any installed charging equipment and its connection to the building wiring.
- The building wiring, including any wall outlet used with a Mobile Connector.
- The electrical connection to the power utility line where it enters the building.

Discuss with the electrician whether the charge current on the vehicle should be lowered, or if the installation should be upgraded to support a higher charge current.

This alert is usually specific to external charging equipment and power sources and does not typically indicate an issue with your vehicle that can be resolved by scheduling service.

You can also try charging your vehicle using a Tesla Supercharger or Destination Charging location, all of which can be located through the map on your vehicle's touchscreen display. See [Maps and Navigation on page 158](#) for more details.

For more information on troubleshooting Mobile Connector or Wall Connector status lights, refer to the product's Owner's Manual at [Charging & Adapter Product Guides](#).

CHG_u002

Charging stopped due to large voltage drop

Remove extension cords / Have wiring inspected

What this alert means:

Charging has been interrupted because the onboard charger in your vehicle has detected an unusually large voltage drop.

Likely causes of this issue include:

- Problems with the building wiring and/or the wall outlet.



Troubleshooting Alerts

- An extension cord or other wiring that cannot support the requested charge current.

This issue can also result from turning on electric devices that draw a lot of power from the same branch circuit while the vehicle is charging.

What to do:

If this issue has occurred multiple times at your normal charging location, contact an electrician to inspect the electrical installation. They should check the following:

- Any installed charging equipment and its connection to the building wiring.
- The building wiring, including any wall outlet used with a Mobile Connector.
- The electrical connection to the power utility line where it enters the building.

Discuss with the electrician whether the charge current on the vehicle should be lowered, or if the installation should be upgraded to support a higher charge current.

This alert is usually specific to external charging equipment and power sources and does not typically indicate an issue with your vehicle that can be resolved by scheduling service.

You can also try charging your vehicle using a Tesla Supercharger or Destination Charging location, all of which can be located through the map on your vehicle's touchscreen display. See [Maps and Navigation on page 158](#) for more details.

For more information on troubleshooting Mobile Connector or Wall Connector status lights, refer to the product's Owner's Manual at [Charging & Adapter Product Guides](#).

CHG_u004

Charging stopped - Power lost while charging Check power source and charging equipment

What this alert means:

Power has been lost during charging. This could result from the charging equipment losing power from the source (for example, a wall outlet) or from an issue with the charging equipment.

What to do:

This alert is often accompanied by other alerts that can help you identify and troubleshoot the issue. Start by investigating any other displayed alerts that relate to charging issues.

Alternatively, you can check Mobile Connector or Wall Connector status lights to confirm power to the device, and also refer to the product owner's manual for troubleshooting information based on blink codes. If using other (non-Tesla) external charging equipment, check for a display or other user interface that provides troubleshooting help.

If there is clearly no power to the charging equipment, check the circuit breaker for the wall outlet / Wall Connector to make sure it has not tripped.

Further troubleshooting tips based on equipment type:

- If using a Mobile Connector, try charging the vehicle with a different wall outlet.
 - If the vehicle starts to charge, the issue was likely with the original wall outlet.
 - If the vehicle still does not charge, the issue may be with the Mobile Connector.
- If using a Wall Connector, try charging the vehicle with different charging equipment like a Mobile Connector powered by a separate wall outlet.
 - If the vehicle starts to charge, the issue was likely with the Wall Connector.

If the issue is with the original wall outlet or the Wall Connector, contact an electrician to inspect the wiring connection.



This alert is usually specific to external charging equipment and power sources and does not typically indicate an issue with your vehicle that can be resolved by scheduling service.

You can also try charging your vehicle using a Tesla Supercharger or Destination Charging location, all of which can be located through the map on your vehicle's touchscreen display. See [Maps and Navigation on page 158](#) for more details.

For more information on troubleshooting Mobile Connector or Wall Connector status lights, refer to the product's Owner's Manual at [Charging & Adapter Product Guides](#).

CHG_u005

Unable to charge - Charge station not powered Check power source or try a different station

What this alert means:

Charging cannot begin because the charging equipment is not ready. A charge handle is detected, but the charging station is not communicating with the vehicle. This issue could occur because:

- The charging station is not powered.
- The control pilot signal between the charging station and the vehicle is interrupted.

This alert is usually specific to external charging equipment and power sources and does not typically indicate an issue with your vehicle that can be resolved by scheduling service.

What to do:

Try charging the vehicle with different charging equipment or at a different charging station.

- If the vehicle begins charging, the issue was likely with the equipment.
- If the vehicle still does not charge, the issue may be with the vehicle.

If using a Mobile Connector or Wall Connector, first check the status lights on the front. If no status lights are visible, check the power source and contact an electrician to inspect the building wiring connection to the wall outlet or the Wall Connector to confirm that all wires are properly connected and torqued.

If using other external charging equipment, consult the product's owner's manual to learn how to confirm that the station is powered. Contact an electrician to inspect the building wiring and charging equipment as necessary.

For more information on troubleshooting Mobile Connector or Wall Connector status lights, refer to the product's Owner's Manual at [Charging & Adapter Product Guides](#).

You can also try charging your vehicle using a Tesla Supercharger or Destination Charging location, all of which can be located through the map on your vehicle's touchscreen display. See [Maps and Navigation on page 158](#) for more details.

CHG_u006

Charge port latch not engaged Fully insert charge cable or check for obstruction

What this alert means:

The charge port latch is unable to latch the charge cable in the charge port inlet. If the latch is not engaged, AC charging (for example, charging with a Mobile Connector or Wall Connector) will be limited to 16A and DC Fast Charging / Supercharging will be unavailable.

The charge port light will pulse amber if this alert appears during AC charging and will be solid amber if this alert appears when attempting to DC Fast Charge / Supercharge.

This alert is usually specific to external charging equipment and power sources and does not typically indicate an issue with your vehicle that can be resolved by scheduling service.



Troubleshooting Alerts

What to do:

Try re-inserting the charge cable fully into the charge port inlet.

If your vehicle begins charging and the charge port light pulses green, the charge cable may not have been fully inserted before. AC charging should no longer be limited, and DC Fast Charging / Supercharging should be available.

If charging is still limited or the vehicle will not charge at all, inspect the charge port inlet and the charge cable connector for any obstructions, such as debris, moisture, and/or foreign objects. Make sure any charge port inlet obstruction has been removed and any moisture has been allowed to dry, then try re-inserting the cable into the charge port.

If charging is still limited or the vehicle will not charge at all, make sure the charge port latch manual release cable (located on the left-hand side in the trunk) has not been pulled. Make sure the handle (usually ring-shaped or a strap) for the manual release cable is free of obstructions and that nothing is attached to it (like a cargo net or umbrella). For more information on using the charge port manual release, see [Manually Releasing Charge Cable on page 176](#).

You can also try charging your vehicle using a Tesla Supercharger or Destination Charging location, all of which can be located through the map on your vehicle's touchscreen display. See [Maps and Navigation on page 158](#) for more details.

For more information on troubleshooting Mobile Connector or Wall Connector status lights, refer to the product's Owner's Manual at [Charging & Adapter Product Guides](#).

For more information on charging, see [Charging Instructions on page 172](#).

CHG_u007

Charging equipment reports error

Check equipment for error code or message

What this alert means:

Charging was interrupted because the external charging equipment has reported a fault that prevents the vehicle from charging.

This alert is usually specific to external charging equipment and power sources and does not typically indicate an issue with your vehicle that can be resolved by scheduling service.

What to do:

Inspect the external charging equipment and look for status lights, displays, or other status indicators on the equipment. For more information on troubleshooting Mobile Connector or Wall Connector status lights, refer to the product's Owner's Manual at [Charging & Adapter Product Guides](#).

Try charging the vehicle with different charging equipment or at a different charging station.

- If the vehicle begins charging, the issue was likely with the equipment.
- If the vehicle still does not charge, the issue may be with the vehicle.

You can also try charging your vehicle using a Tesla Supercharger or Destination Charging location, all of which can be located through the map on your vehicle's touchscreen display. See [Maps and Navigation on page 158](#) for more details.

CHG_u010

External charging equipment error detected

Try different charging equipment

What this alert means:

AC charging cannot begin due to a condition that prevents your vehicle from charging with AC power. DC fast charging / Supercharging should still function as expected.

Your vehicle's onboard charger is detecting input voltage at the charge port when no power has been requested from the external charging equipment, which indicates the external charging equipment is not functioning as expected.



This can sometimes be caused by a hardware issue specific to the external charging equipment, which prevents the charging equipment from switching power to the vehicle on or off when requested. It could also occur due to another condition affecting the external charging equipment, or a condition affecting your vehicle itself.

What to do:

This alert is usually specific to external charging equipment and power sources and does not typically indicate an issue with your vehicle that can be resolved by scheduling service.

Try charging with multiple, different types of charging equipment.

You can also try charging your vehicle using a Tesla Supercharger or Destination Charging location, all of which can be located through the map on your vehicle's touchscreen display. See [Maps and Navigation on page 158](#) for more details.

For more information on troubleshooting Mobile Connector or Wall Connector status lights, refer to the product's Owner's Manual at [Charging & Adapter Product Guides](#).

CHG_u012

Power grid or vehicle issue limiting AC charging Unplug and retry / Try different charging location

What this alert means:

Charging speed has been reduced due to a condition that affects your vehicle's ability to charge with AC power. DC fast charging / Supercharging should still function as expected.

This may be due to power supply disturbances caused by the external charging equipment or by the electrical power grid. In some cases, this condition may be the result of using nearby electric devices that draw a lot of power.

If these possible causes can be ruled out, then a condition with your vehicle itself may also be affecting AC charging.

What to do:

If this alert is accompanied by another alert that specifies the condition affecting AC charging, start by investigating that alert.

Further troubleshooting tips based on equipment type:

- If using a Mobile Connector, try charging the vehicle with a different wall outlet.
 - If the vehicle starts to charge, the issue was likely with the original wall outlet.
 - If the vehicle still does not charge, the issue may be with the Mobile Connector.
- If using a Wall Connector, try charging the vehicle with different charging equipment like a Mobile Connector powered by a separate wall outlet.
 - If the vehicle starts to charge, the issue was likely with the Wall Connector.

If the issue is with the original wall outlet or the Wall Connector, contact an electrician to inspect the wiring connection.

You can also try charging your vehicle using a Tesla Supercharger or Destination Charging location, all of which can be located through the map on your vehicle's touchscreen display. See [Maps and Navigation on page 158](#) for more details.

If this alert persists when attempting to charge at multiple locations and with different charging equipment, it is recommended that you schedule service.

For more information on troubleshooting Mobile Connector or Wall Connector status lights, refer to the product's Owner's Manual at [Charging & Adapter Product Guides](#).



CHG_u013

Charging equipment communication lost

Check power source and charging equipment

What this alert means:

Charging stopped because communication between the vehicle and the external charging equipment was interrupted.

This alert is usually specific to external charging equipment and power sources and does not typically indicate an issue with your vehicle that can be resolved by scheduling service.

What to do:

Confirm whether the external charging equipment is powered by looking for any status lights, displays, or other indicators on the equipment. For more information on troubleshooting Mobile Connector or Wall Connector status lights, refer to the product's Owner's Manual at [Charging & Adapter Product Guides](#).

If the equipment is **not** powered, try to restore the external charging equipment's power source.

- If attempting to charge at a public station and power is unable to be restored, contact the station operator.
- If attempting to charge at a private station (for example: charging at home) and power is unable to be restored, contact an electrician.

If the equipment is powered, try charging the vehicle using different external charging equipment.

- If the vehicle begins charging, the issue was likely with the equipment.
- If the vehicle still does not charge, the issue may be with the vehicle.

You can also try charging your vehicle using a Tesla Supercharger or Destination Charging location, all of which can be located through the map on your vehicle's touchscreen display. See [Maps and Navigation on page 158](#) for more details.

For more information on troubleshooting Mobile Connector or Wall Connector status lights, refer to the product's Owner's Manual at [Charging & Adapter Product Guides](#).

CHG_u014

Charging equipment reports error

Check equipment for error code or message

What this alert means:

Charging was interrupted because the external charging equipment has reported a fault that prevents the vehicle from charging.

This alert is usually specific to external charging equipment and power sources and does not typically indicate an issue with your vehicle that can be resolved by scheduling service.

What to do:

Inspect the external charging equipment and look for status lights, displays, or other status indicators on the equipment. For more information on troubleshooting Mobile Connector or Wall Connector status lights, refer to the product's Owner's Manual at [Charging & Adapter Product Guides](#).

Try charging the vehicle with different charging equipment or at a different charging station.

- If the vehicle begins charging, the issue was likely with the equipment.
- If the vehicle still does not charge, the issue may be with the vehicle.

You can also try charging your vehicle using a Tesla Supercharger or Destination Charging location, all of which can be located through the map on your vehicle's touchscreen display. See [Maps and Navigation on page 158](#) for more details.



CHG_w032

Charge rate reduced - Wall connection hot Outlet or Wall Connector wiring must be checked

What this alert means:

High temperature detected by Wall Connector alerts indicate the building connection to the Wall Connector is getting too warm, so charging has been slowed to protect the wiring and Wall Connector.

This is not typically an issue with your vehicle or your Wall Connector, but rather an issue with the building wiring. This may be caused by a loose building wiring connection to the Wall Connector and can be fixed quickly by an electrician.

What to do:

Contact an electrician to inspect the building wiring connection to the Wall Connector. They should make sure that all wires are properly connected and torqued according to the installation guide for the Wall Connector.

Wall Connector installation guides can be found [here](#).

CHG_w037

Unable to charge - Wall connection too hot Outlet or Wall Connector wiring must be checked

What this alert means:

High temperature detected by Wall Connector alerts indicate the building connection to the Wall Connector is getting too warm, so charging has been slowed to protect the wiring and Wall Connector.

This is not typically an issue with your vehicle or your Wall Connector, but rather an issue with the building wiring. This may be caused by a loose building wiring connection to the Wall Connector and can be fixed quickly by an electrician.

What to do:

Contact an electrician to inspect the building wiring connection to the Wall Connector. They should make sure that all wires are properly connected and torqued according to the installation guide for the Wall Connector.

For more information, see the [installation guide](#) for your Wall Connector.

CP_w043

Charge port door sensor fault Charge port may not operate as expected

What this alert means:

One of the charge port door sensors is not functioning normally. When this occurs, the charge port may be unable to accurately sense the charge port door position and the charge port may not operate as expected.

- The charge port latch may intermittently remain engaged when the charge port door is opened.
- The charge port light may illuminate only intermittently when the charge port door is opened.

What to do:

Try closing the charge port door and then opening it again.

For more information, see [Opening the Charge Port on page 172](#).

For more information on charging, see [Charging Instructions on page 172](#).



CP_w054

Charge port latch not engaged Fully insert charge cable or check for obstruction

What this alert means:

The charge port latch is unable to latch the charge cable in the charge port inlet. If the latch is not engaged, AC charging (for example, charging with a Mobile Connector or Wall Connector) will be limited to 16A and DC Fast Charging / Supercharging will be unavailable.

The charge port light will pulse amber if this alert appears during AC charging and will be solid amber if this alert appears when attempting to DC Fast Charge / Supercharge.

This alert is usually specific to external charging equipment and power sources and does not typically indicate an issue with your vehicle that can be resolved by scheduling service.

What to do:

Try re-inserting the charge cable fully into the charge port inlet.

If your vehicle begins charging and the charge port light pulses green, the charge cable may not have been fully inserted before. AC charging should no longer be limited, and DC Fast Charging / Supercharging should be available.

If charging is still limited or the vehicle will not charge at all, inspect the charge port inlet and the charge cable connector for any obstructions, such as debris, moisture, and/or foreign objects. Make sure any charge port inlet obstruction has been removed and any moisture has been allowed to dry, then try re-inserting the cable into the charge port.

If charging is still limited or the vehicle will not charge at all, make sure the charge port latch manual release cable (located on the left-hand side in the trunk) has not been pulled. Make sure the handle (usually ring-shaped or a strap) for the manual release cable is free of obstructions and that nothing is attached to it (like a cargo net or umbrella). For more information on using the charge port manual release, see [Manually Releasing Charge Cable on page 176](#).

You can also try charging your vehicle using a Tesla Supercharger or Destination Charging location, all of which can be located through the map on your vehicle's touchscreen display. See [Maps and Navigation on page 158](#) for more details.

For more information on troubleshooting Mobile Connector or Wall Connector status lights, refer to the product's Owner's Manual at [Charging & Adapter Product Guides](#).

For more information on charging, see [Charging Instructions on page 172](#).

DI_f138

Front motor disabled - OK to drive Vehicle power may be limited

What this alert means:

Your vehicle's front motor is unavailable. Power, speed, and acceleration may be reduced as your vehicle uses the rear motor(s) to continue driving.

What to do:

Continue to your destination. Your vehicle is OK to drive.

This alert may be caused by a temporary condition that will be resolved automatically. If this alert clears during your current drive, or is no longer present when you start your next drive, it was likely caused by a temporary condition. No action is required.

This alert may also indicate a condition requiring front motor inspection and service. If this alert persists throughout subsequent drives, it is recommended that you schedule service. Your vehicle is OK to drive in the meantime.



DI_u006

Vehicle automatically parked to prevent rollaway Fasten seatbelt and close door to stay in gear

What this alert means:

Your vehicle has automatically shifted into Park (P) because it determined the driver was leaving or no longer present. This is expected vehicle behavior under various circumstances.

Your vehicle will automatically shift into Park if **all** of these conditions are true:

- Autopark is not active
- Your vehicle is traveling slower than 1.4 mph (2.25 km/h) in Drive or Reverse
- The last driver activity was detected more than 2 seconds ago. Driver activity includes:
 - Pressing the brake and/or accelerator pedal

And at least **two** of these conditions are true:

1. Driver seatbelt is detected as unbuckled.
2. Driver is not detected as present.
3. Driver door is detected as open.

NOTE: If your vehicle is running software from 2015 or later, it will automatically shift into Park immediately when **all three** of the conditions above are true, regardless of vehicle speed or last detected press of the brake / accelerator pedal.

Your vehicle will also automatically shift into Park if **all** of these conditions are true:

- Vehicle hold is engaged
- Your vehicle is in Drive (D) or Reverse (R)
- Driver door is detected as open

NOTE: Your vehicle will also automatically shift into Park when a charge cable is connected to the charge port.

What to do:

For more information on automatic shifting into Park, see [Shifting on page 82](#).

DI_u015

Cruise control unavailable

What this alert means:

Cruise Control, including Traffic-Aware Cruise Control, is currently unavailable.

Cruise Control might be unavailable because:

- The driver canceled the request.
- The driver unbuckled their seatbelt.
- The front trunk, trunk, or a door is open.
- The vehicle is traveling below the Cruise Control minimum speed of 18 mph (30 km/h).
- There is an environmental condition, such as limited visibility.
- Valet mode is active.

What to do:



Troubleshooting Alerts

Take control and drive your vehicle manually.

When any condition preventing Cruise Control activation is no longer present, Cruise Control should be available. If this alert persists throughout subsequent drives, schedule service at your earliest convenience. Your vehicle is OK to drive in the meantime.

For more information, see [Traffic-Aware Cruise Control on page 118](#).

DI_u024

Autopark canceled

Take control

What this alert means:

Autopark has been canceled.

Autopark might have been canceled because:

- The driver pressed the Cancel button on the touchscreen.
- The driver moved the steering wheel.
- The driver pressed the accelerator pedal, pressed the brake pedal, or opened a door.
- There is a steep slope / grade.
- There is a weather condition affecting visibility.
- The curb cannot be detected.
- A trailer is attached to the vehicle.

What to do:

Park, or finish parking, your vehicle manually.

Autopark should be available again during your next drive.

For more information, see [#unique_658 on page](#) and [#unique_659 on page](#) .

DI_u025

Autopark aborted

What this alert means:

Autopark has aborted and the Electronic Parking Brake has been applied.

Autopark might have been canceled because:

- The driver pressed the Cancel button on the touchscreen.
- The driver moved the steering wheel.
- The driver pressed the accelerator pedal, pressed the brake pedal, or opened a door.
- There is a steep slope / grade.
- There is a weather condition affecting visibility.
- The curb cannot be detected.
- A trailer is attached to the vehicle.

What to do:

Park, or finish parking, your vehicle manually.

Autopark should be available again during your next drive.



For more information, see [#unique_658 on page](#) and [#unique_659 on page](#) .

DI_u032

Adaptive ride control disabled

Drive with caution

What this alert means:

The speed of your vehicle is limited to 90 mph (144 km/h) due to an issue with the Adaptive Suspension Damping system.

The system cannot provide real-time adjustments to the suspension system to optimize both ride and handling, and as a result your ride may be softer than usual.

What to do:

If this alert persists throughout subsequent drives, schedule service at your earliest convenience. Your vehicle is OK to drive in the meantime.

This alert is accompanied by a red indicator light on the instrument panel. For more information, see [Air Suspension on page 90](#).

DI_w039

Regenerative braking unavailable

Use brake pedal as needed

What this alert means:

Regenerative braking performance is temporarily reduced, and there is less automatic deceleration when you lift your foot off the accelerator pedal while driving.

This alert may occur when:

- High voltage battery is near full charge. Regenerative braking is reduced when the battery is at 95% charge or higher.
- High voltage battery is not warm enough. This can happen at the beginning of a drive. It may happen frequently in colder climates.

What to do:

Your vehicle is OK to drive.

Use the brake pedal as needed to slow your vehicle, just as you would in a gas-powered, non-electric vehicle.

Driving your vehicle usually clears this alert, because it reduces the battery charge below 95% and/or sufficiently heats the battery.

NOTE: In colder climates, this alert may remain present indefinitely and automatic deceleration may remain limited, as driving your vehicle may not heat the battery enough to restore full regenerative braking performance. You can use Defrost Car in the Tesla Mobile App to warm up the high voltage battery before you drive and restore normal regenerative braking. For more information, see [Cold Weather Best Practices on page 155](#).

This alert, by itself, does not typically indicate a condition requiring service. If this alert persists across drives, it may indicate a condition affecting your vehicle's regenerative braking ability, and it is recommended you schedule service at your earliest convenience.

For more information, see [Regenerative Braking on page 87](#).



DI_w138

Front motor disabled - OK to drive Vehicle power may be limited

What this alert means:

Your vehicle's front motor is unavailable. Power, speed, and acceleration may be reduced as your vehicle uses the rear motor(s) to continue driving.

What to do:

Continue to your destination. Your vehicle is OK to drive.

This alert may be caused by a temporary condition that will be resolved automatically. If this alert clears during your current drive, or is no longer present when you start your next drive, it was likely caused by a temporary condition. No action is required.

This alert may also indicate a condition requiring front motor inspection and service. If this alert persists throughout subsequent drives, it is recommended that you schedule service. Your vehicle is OK to drive in the meantime.

DI_w168

Vehicle Hold feature unavailable Keep brake pedal pressed while stopped

What this alert means:

Vehicle Hold is currently unavailable due to system constraints. When stopping, use the brake pedal to bring your vehicle to a complete stop and keep your vehicle stationary.

What to do:

Continue to your destination. Your vehicle is OK to drive.

If this alert persists throughout subsequent drives, schedule service at your earliest convenience. Your vehicle is OK to drive in the meantime.

For more information, see [Vehicle Hold on page 94](#).

DI_w172

Powertrain requires service Avoid hard acceleration

What this alert means:

An issue has been detected in the powertrain system.

Your vehicle has detected excessive backlash (lash) between the drive unit and the wheels. High, or excessive, lash is indicative of mechanical wear.

There are many possible causes, so a powertrain inspection is needed.

What to do:

It is recommended that you schedule service as soon as possible for a powertrain inspection.

Your vehicle is OK to drive in the meantime. You can drive to your immediate destination and to a service center. Avoid hard or heavy acceleration, as this puts more stress on the powertrain.

Schedule a service appointment at your earliest opportunity. If this issue is not addressed, your vehicle might unexpectedly stop while you are driving.



GTW_w017

Electrical system power reduced Non-essential features may be unavailable

What this alert means:

Some non-essential features, like seat heaters or cabin heating / cooling, may be unavailable or may operate at a reduced level. This is expected behavior designed to help your vehicle maintain adequate electrical power for essential functions.

What to do:

This alert may be present due to various vehicle conditions. For more information and further recommended actions, check for other alerts specific to conditions affecting your vehicle's electrical system.

GTW_w018

Electrical system power reduced Non-essential features may be unavailable

What this alert means:

Some non-essential features, like seat heaters or cabin heating / cooling, may be unavailable or may operate at a reduced level. This is expected behavior designed to help your vehicle maintain adequate electrical power for essential functions.

What to do:

This alert may be present due to various vehicle conditions. For more information and further recommended actions, check for other alerts specific to conditions affecting your vehicle's electrical system.

GTW_w174

12V battery must be replaced - Schedule service Software will not update until battery is replaced

What this alert means:

The low voltage battery is showing degraded performance and needs to be replaced. Until the low voltage battery is replaced, vehicle software updates will not complete.

What to do:

It is recommended that you have the low voltage battery replaced at your earliest convenient opportunity.

You can schedule service via your Tesla Mobile App, or with an independent service provider that offers low voltage battery replacement for your vehicle. Please note that independent service provider options may vary, based on your vehicle configuration and your location.

Your vehicle is OK to drive with this alert present. However, if you delay the low voltage battery replacement, your vehicle may eventually not have enough electrical power to start or to restart after a recent drive.

If the low voltage battery does not have enough electrical power to turn on your vehicle or open the doors, see [Battery Care on page 170](#) for recommended actions.

For more information on the battery system, see [High Voltage Battery Information on page 170](#).

GTW_w360

Assist for low brake performance activated To stop, keep brake pedal firmly pressed

What this alert means:



Troubleshooting Alerts

Hydraulic Fade Compensation is active. This brake assist function activates temporarily to make sure you have full braking capability in conditions where reduced braking performance is detected by your vehicle.

When this assist function activates, you may feel the brake pedal pull away from your foot and notice a strong increase in brake pressure. You may also hear a pumping sound coming from the brake hydraulic unit at the front of the vehicle. This will usually last for a few seconds, depending on road surface and vehicle speed. This is completely normal and does not indicate any issue with your vehicle.

What to do:

Continue to press the brake pedal as you normally would, and do not "pump" (repeatedly press and release) the pedal as this will interrupt the function.

This alert will clear when your vehicle comes to a stop or you are no longer pressing the brake pedal. It may still be displayed for up to 5 seconds afterward.

Reduced braking performance is usually temporary, and can occur for a number of reasons including high brake temperatures after heavy brake use, or driving in extremely cold or wet conditions. It can also indicate that your brake pads or rotors have worn to the point that normal replacement is needed.

If you continue to experience reduced braking performance which does not improve over time, please contact Tesla service at your convenience for a brake inspection.

For more information, see [Hydraulic Fade Compensation on page 87](#).

GTW_w405

Electrical system power reduced Vehicle may shut down unexpectedly

What this alert means:

The electrical system cannot maintain the voltage required to support all vehicle features.

If this alert is present while you are driving, it is possible your vehicle will shut down unexpectedly.

It is also possible that your vehicle will not restart after the current drive.

What to do:

It is recommended that you eliminate or reduce your use of any non-essential features. This can help your vehicle maintain adequate electrical power for essential functions. It may also prevent your vehicle from shutting down before you reach your immediate destination, although this is not guaranteed.

If this alert remains active, schedule service immediately. Without service, your vehicle may shut down unexpectedly or may not restart.

MCU_u005

Front trunk open Proceed with caution

What this alert means:

Your vehicle's front trunk (hood) is detected open while driving.

This alert indicates at least one of the two latches securing the hood, the front trunk primary and/or secondary latch, cannot be confirmed closed (confirmed as fully secured) when your vehicle is shifted into a gear other than Park.

What to do:

As this condition may lead to the front trunk opening while driving, it is recommended that you drive carefully until you can safely bring your vehicle to a stop and shift into Park.



Once your vehicle is parked, check the front trunk (hood) to make sure it is fully closed (both latches are fully engaged). For more information, see [Closing instructions for the Front Trunk on page 32](#).

The alert should clear once your vehicle is shifted into Park. However, it may return once you start driving if you do not first inspect and fully secure the hood.

If this alert persists across multiple drives, or occurs with increasing frequency over several drives, it is recommended that you schedule service at your earliest convenience.

For more information on the front trunk, see [Front Trunk on page 32](#).

MCU_u019

Active service connection to vehicle Service performing remote diagnostics

What this alert means:

A service technician is remotely logged into your vehicle for diagnosis or repair. You may notice some loss of Infotainment functionality while the connection persists, but this alert does not indicate an issue with your vehicle.

Your vehicle is OK to drive.

What to do:

This alert should clear automatically after the technician completes vehicle diagnosis or repair. You may find it necessary to restart your touchscreen to restore full Infotainment functionality after the alert has cleared. For more information, see [Restarting the Touchscreen in your vehicle's Do It Yourself Guide](#).

If this alert does not clear after 24 hours, it is recommended that you schedule service via your Tesla Mobile App or with an independent service provider. Please note that independent service provider options may vary, based on your vehicle configuration and your location.

MCU_w008

Air pressure in tires very low PULL OVER SAFELY - Check for flat tire

What this alert means:

This alert indicates that one or more of the tires on your vehicle is extremely low or flat.

The tire pressure monitoring system (TPMS) has detected that the air pressure in one or more of your tires is significantly lower than the recommended cold tire pressure.

What to do:

You should pull over carefully as soon as possible. In a safe location, check for a flat tire.

You can request Tesla roadside assistance options (mobile tire, loaner wheel, tow) if required. See [Contacting Tesla Roadside Assistance on page 215](#) for more information.

In a non-emergency situation, it is recommended that you visit a local tire shop for assistance or schedule service using your Tesla Mobile App.

See [Maintaining Tire Pressures on page 185](#) for detailed information on where to find the recommended cold pressure (RCP) for your vehicle's tires, how to check tire pressures, and how to keep your tires properly inflated.

The alert will clear once the TPMS has a consistent tire pressure measurement for each of your tires within 3 psi of the recommended cold pressure.

- The alert and Tire Pressure indicator light may still be present immediately after you have filled your tires to the recommended cold pressure, but both should clear once you have driven a short distance.



Troubleshooting Alerts

- You may need to drive over 15 mph (25 km/h) for at least 10 minutes for the Tire Pressure Monitoring System to measure and report your updated tire pressures.

For more information on tire pressure and inflation, see [Tire Care and Maintenance on page 185](#).

MCU_w010

Air pressure below recommendation for tires Check pressure and refill air as needed

What this alert means:

This alert does NOT indicate that there is a flat tire.

The tire pressure monitoring system (TPMS) has detected that the air pressure in one or more of your tires is at least 20% lower than the recommended cold tire pressure.

See [Maintaining Tire Pressures on page 185](#) for detailed information on where to find the recommended cold pressure (RCP) for your vehicle's tires, how to check tire pressures, and how to keep your tires properly inflated.

This alert may appear in cold weather because the air in your tires naturally contracts when it becomes cold, decreasing tire pressures.

What to do:

Add air to maintain the recommended cold tire pressure. Although drops in tire pressure are expected in colder weather, the recommended cold tire pressure should be maintained at all times.

The alert may clear as the vehicle is driven. This is because the tires will warm up and the tire pressure will increase. Even if the alert clears, the tires should still be refilled with air once they have cooled.

The alert will clear once the Tire Pressure Monitoring System detects that each of your tires is inflated to the recommended cold pressure.

- The alert and Tire Pressure indicator light may still be present immediately after you have filled your tires to the recommended cold pressure, but both should clear once you have driven a short distance.
- You may need to drive over 15 mph (25 km/h) for at least 10 minutes for the Tire Pressure Monitoring System to measure and report your updated tire pressures.

If you repeatedly see this alert for the same tire, have the tire inspected for a slow leak. You can visit a local tire shop or schedule service using your Tesla Mobile App.

For more information on tire pressure and inflation, see [Tire Care and Maintenance on page 185](#).

For more information on tire pressure and inflation, see [Tire Care and Maintenance on page 185](#).

MCU_w029

Service is required Schedule service now

What this alert means:

This alert is set remotely by Tesla when a condition requiring service is detected on your vehicle.

This alert can be set due to various conditions. When you schedule service, more information should be available.

This alert can only be cleared by a service technician after your vehicle has been serviced.

What to do:



As this alert can be present due to various conditions, it is recommended that you schedule service at your earliest convenience.

TAS_a313

Adaptive ride control degraded Ride comfort may be reduced

What this alert means:

There is an issue with your vehicle's Adaptive Suspension Damping system. As a result, the system cannot provide real-time adjustments to the suspension system to optimize both ride and handling.

Instead, all dampers are receiving fixed current. Your ride may be softer or firmer than usual.

What to do:

If this alert persists throughout subsequent drives, schedule service at your earliest convenience. Your vehicle is OK to drive in the meantime.

This alert is accompanied by a yellow indicator light on the instrument panel. For more information, see [Air Suspension on page 90](#).

TAS_a314

Adaptive ride control degraded

What this alert means:

There is an issue with your vehicle's Adaptive Suspension Damping system. As a result, the system cannot provide real-time adjustments to the suspension system to optimize both ride and handling, and your ride may be softer than usual.

What to do:

If this alert persists throughout subsequent drives, schedule service at your earliest convenience. Your vehicle is OK to drive in the meantime.

This alert is accompanied by a red indicator light on the instrument panel. For more information, see [Air Suspension on page 90](#).

THC_u0005

Air conditioning temporarily reduced Vehicle systems being cooled

What this alert means:

Cabin air conditioning performance has been temporarily reduced because your vehicle needs to focus on cooling the high voltage battery (Battery) and/or powertrain. This is completely normal and does not indicate a problem with your vehicle or the air conditioning (A/C) system.

In addition to cooling the vehicle interior, the A/C system also cools the Battery. The A/C system's priority is to cool the Battery to make sure it stays within an optimal temperature range that supports longevity and best performance.

In high temperature environments, it is normal for your vehicle to focus more for brief periods on cooling the Battery. When this happens, it is most often because the vehicle is supercharging in hot weather.

What to do:

No action is required. Your vehicle is OK to drive.

The alert should clear in a short time, and cabin air conditioning performance should return to normal. In some cases, the alert and vehicle behavior will continue until supercharging is complete.



Troubleshooting Alerts

If the alert persists over multiple drives and is accompanied by other alerts that indicate potential issues with the A/C system, contact Tesla Service at your convenience to schedule an A/C system inspection.

THC_w0100

Battery heating unavailable - Charge rate reduced Charging may be unavailable in cold temperatures

What this alert means:

A condition affecting the performance of your vehicle's high voltage battery heater has been detected.

Without adequate heating of the high voltage battery, charging speed (charge rate) may be reduced. Your vehicle may also be unable to charge in cold ambient temperatures (cold weather) while high voltage battery heating remains unavailable.

What to do:

Your vehicle is OK to drive. Your vehicle is also OK to charge and connect to a charging station. However, your vehicle may be unable to charge, or may charge more slowly than expected, in cold ambient temperatures.

If possible, try charging your vehicle in a closed environment like a garage, where warmer ambient temperatures may make high voltage battery heating unnecessary.

If driving in cold ambient temperatures, it is recommended that you do **NOT** rely on charging stations along your route to reach your destination, as the high voltage battery may be too cold to charge.

- If you need to charge, try to charge your vehicle immediately after a drive. The high voltage battery may still be warm from the previous drive.
- Leaving your vehicle parked in cold ambient temperatures after a drive will cause the high voltage battery to cool, and charging may become unavailable.

Similarly, it is recommended that you do not rely on regenerative braking to charge the high voltage battery while driving in cold ambient temperatures, as regenerative braking may be unavailable if the battery temperature is too low. For more information, see [Regenerative Braking on page 87](#).

This alert may be present due to many conditions. It may be caused by a temporary condition that requires no action to resolve.

However, if this alert persists over multiple drives, or is accompanied by other alerts indicating potential issues with your vehicle's heating and/or air conditioning system, it is recommended that you schedule service at your earliest reasonable opportunity.

For more information on charging, see [Charging Instructions on page 172](#).

For more information on the high voltage battery, see [High Voltage Battery Information on page 170](#).

UMC_w001

Unable to charge with Mobile Connector Inadequate outlet grounding - Try another outlet

What this alert means:

The Mobile Connector has detected that the electrical outlet has insufficient grounding, likely caused by an inadequate or missing ground connection.

This does not indicate an issue with your Mobile Connector or vehicle, but instead points to an issue with the wall outlet / electrical installation the Mobile Connector is connected to.

What to do:



Have the electrical installation inspected by an electrician. Your electrician should make sure there is proper grounding at your circuit breaker or power distribution box, and also make sure that appropriate connections are made to the outlet, before you attempt to plug in the Mobile Connector again.

If you need to charge in the meantime, try charging using a different outlet, at another location, or with another type of charging station.

You can also try charging your vehicle using a Tesla Supercharger or Destination Charging location, all of which can be located through the map on your vehicle's touchscreen display. See [Maps and Navigation on page 158](#) for more details.

For more information on troubleshooting Mobile Connector status lights and charging issues, refer to the [product's owner's manual](#).

UMC_w002

Unable to charge - Mobile Connector GFCI tripped Unplug charge handle from charge port and retry

What this alert means:

The vehicle cannot charge because the ground-fault circuit interrupter (GFCI) in the Mobile Connector has tripped.

Like the GFCI in a wall outlet, this feature is designed to stop the flow of electricity when there is a problem. It has interrupted charging to protect your vehicle and the charging equipment.

This could happen for many reasons. The problem could be in the charge cable, the charge handle, the charge port, or even an onboard vehicle component.

What to do:

Inspect the charge port and the charge handle for pooled water or unusual levels of moisture. If you find excessive moisture, wait and let both the inside area of the charge port and the exposed portion of the charge handle dry sufficiently before trying again.

Inspect the charge equipment for damage.

- If the cable is in any way damaged or deteriorated, **do not use it**. Try different charging equipment instead.
- If the cable is in good condition, try charging again with the same Mobile Connector.

If the issue persists and prevents charging, try charging with different charging equipment.

This alert is usually specific to external charging equipment and power sources and does not typically indicate an issue with your vehicle that can be resolved by scheduling service.

You can also try charging your vehicle using a Tesla Supercharger or Destination Charging location, all of which can be located through the map on your vehicle's touchscreen display. See [Maps and Navigation on page 158](#) for more details.

For more information on troubleshooting Mobile Connector status lights and charging issues, refer to the [product's owner's manual](#).

UMC_w004

Unable to charge with Mobile Connector Voltage too high / Try a different wall outlet

What this alert means:

The vehicle cannot charge, or charging is interrupted, because **either** the Mobile Connector:

- Detects the wall outlet voltage is too high, **or**
- Detects an unexpected increase in supply voltage from the wall outlet.



What to do:

Try charging the vehicle with a different wall outlet. If the vehicle starts to charge, the issue was likely with the original wall outlet. Contact an electrician to inspect the building wiring connection to that outlet.

If the vehicle still does not charge when you try a different wall outlet, try charging at a different location.

You can also try charging your vehicle using a Tesla Supercharger or Destination Charging location, all of which can be located through the map on your vehicle's touchscreen display. See [Maps and Navigation on page 158](#) for more details.

For more information on troubleshooting Mobile Connector status lights and charging issues, refer to the [product's owner's manual](#).

UMC_w005

Unable to charge with Mobile Connector Voltage too low / Try a different wall outlet

What this alert means:

The vehicle cannot charge, or charging is interrupted, because **either** the Mobile Connector:

- Does not detect enough supply voltage from the wall outlet, **or**
- Detects an unexpected drop in supply voltage from the wall outlet.

What to do:

Try charging the vehicle with a different wall outlet. If the vehicle starts to charge, the issue was likely with the original wall outlet. Contact an electrician to inspect the building wiring connection to that outlet.

If the vehicle still does not charge when you try a different wall outlet, try charging at a different location.

This alert is usually specific to external charging equipment and power sources and does not typically indicate an issue with your vehicle that can be resolved by scheduling service.

You can also try charging your vehicle using a Tesla Supercharger or Destination Charging location, all of which can be located through the map on your vehicle's touchscreen display. See [Maps and Navigation on page 158](#) for more details.

For more information on troubleshooting Mobile Connector status lights and charging issues, refer to the [product's owner's manual](#).

UMC_w007

Mobile Connector control box temperature high Let Mobile Connector cool to resume charging

What this alert means:

Charging has been interrupted because the Mobile Connector has detected a high temperature inside its control box housing.

What to do:

Make sure the Mobile Connector is not covered by anything, and that there is no heat source nearby. If the problem persists in normal ambient temperatures (under 38°C), service is required.

You can also try charging your vehicle using a Tesla Supercharger or Destination Charging location, all of which can be located through the map on your vehicle's touchscreen display. See [Maps and Navigation on page 158](#) for more details.

For more information on troubleshooting Mobile Connector status lights and charging issues, refer to the [product's owner's manual](#).



UMC_w008

Unable to charge - Wall plug temperature high Wall outlet and wiring inspection recommended

What this alert means:

High temperature detected by Mobile Connector alerts indicate the outlet used to charge is becoming too warm, so charging has stopped to protect the outlet.

This does not indicate an issue with your Mobile Connector or vehicle, but instead points to an issue with the wall outlet / electrical installation the Mobile Connector is connected to.

A warm outlet may be caused by a plug that is not fully inserted, a loose building wiring connection to the outlet, or an outlet that is beginning to wear out.

What to do:

Make sure your adapter is fully plugged into the outlet. If charging speed does not return to normal, contact an electrician to inspect the outlet and building wiring connections to the outlet and complete any repairs needed.

If the outlet is worn, it should be replaced with a high-quality outlet. Consider upgrading to a Tesla Wall Connector for greater convenience and highest charging speed.

UMC_w009

Cannot charge - Charge handle temperature high Check charge handle or charge port for debris

What this alert means:

Charging has been interrupted because the Mobile Connector has detected a high temperature in the charge handle that connects to your vehicle's charge port.

What to do:

Make sure the Mobile Connector is fully inserted into your vehicle's charge port inlet.

Inspect the charge port inlet and the Mobile Connector handle for any obstructions or moisture. Make sure any obstruction in the charge port or Mobile Connector handle has been removed and any moisture has been allowed to dry, then try re-inserting the Mobile Connector handle into the charge port.

Also make sure the charge handle of the Mobile Connector is not covered by anything, and that there is no heat source nearby.

If the alert persists in normal ambient temperatures (under 38°C), and occurs during multiple charging attempts, this may indicate a condition affecting the Mobile Connector or your vehicle. It is recommended that you schedule service at your convenience.

You can also try charging your vehicle using a Tesla Supercharger or Destination Charging location, all of which can be located through the map on your vehicle's touchscreen display. See [Maps and Navigation on page 158](#) for more details.

For more information on troubleshooting Mobile Connector status lights and charging issues, refer to the [product's owner's manual](#).

UMC_w010

Mobile Connector to adapter connection hot Let cool - Plug adapter fully into Mobile Connector

What this alert means:

Charging has been interrupted because the Mobile Connector has detected a high temperature at the connection between the wall plug adapter and the control box.



Troubleshooting Alerts

What to do:

Make sure the wall plug adapter is fully connected to the Mobile Connector control box.

Also make sure the wall plug adapter is not covered by anything, and that there is no heat source nearby.

After unplugging from the power source (wall outlet), inspect the wall plug adapter connection and the Mobile Connector control box connection for any obstructions or moisture. Make sure any obstruction has been removed and any moisture has been allowed to dry, then try re-inserting the wall plug adapter into the Mobile Connector and then connecting to the power source (wall outlet).

Once the Mobile Connector control box temperature has decreased and any obstruction has been removed, the alert should clear and charging should be possible.

You can also try charging your vehicle using a Tesla Supercharger or Destination Charging location, all of which can be located through the map on your vehicle's touchscreen display. See [Maps and Navigation on page 158](#) for more details.

For more information on troubleshooting Mobile Connector status lights and charging issues, refer to the [product's owner's manual](#).

UMC_w011

Charging equipment communication error Try again or try different equipment

What this alert means:

Your vehicle is unable to charge because it cannot communicate effectively with the Mobile Connector. The Mobile Connector cannot confirm via proximity detection that the charge handle is fully connected to your vehicle.

What to do:

First, confirm the lack of effective communication is caused by the Mobile Connector rather than an issue with your vehicle. This is usually the case.

To confirm this, try charging the vehicle using different external charging equipment.

- If the vehicle begins charging, the issue was likely with the Mobile Connector.
- If the vehicle still does not charge, the issue may be with the vehicle.

Inspect the charge port inlet and the Mobile Connector handle for any obstructions (use a flashlight as necessary). Make sure any obstruction has been removed and any moisture has been allowed to dry, then try re-inserting the Mobile Connector handle into the charge port.

This alert is usually specific to external charging equipment and power sources and does not typically indicate an issue with your vehicle that can be resolved by scheduling service.

You can also try charging your vehicle using a Tesla Supercharger or Destination Charging location, all of which can be located through the map on your vehicle's touchscreen display. See [Maps and Navigation on page 158](#) for more details.

For more information on troubleshooting Mobile Connector status lights and charging issues, refer to the [product's owner's manual](#).

For more information on charging, see [Charging Instructions on page 172](#).

UMC_w012

Charging equipment communication error Try again or try different equipment

What this alert means:



Your vehicle is unable to charge because it cannot communicate effectively with the Mobile Connector. The Mobile Connector detects that it cannot generate or maintain a valid control pilot signal.

What to do:

First, confirm the lack of effective communication is caused by the Mobile Connector rather than an issue with your vehicle. This is usually the case.

To confirm this, try charging the vehicle using different external charging equipment.

- If the vehicle begins charging, the issue was likely with the Mobile Connector.
- If the vehicle still does not charge, the issue may be with the vehicle.

Inspect the charge port inlet and the Mobile Connector handle for any obstructions (use a flashlight as necessary). Make sure any obstruction has been removed and any moisture has been allowed to dry, then try re-inserting the Mobile Connector handle into the charge port.

This alert is usually specific to external charging equipment and power sources and does not typically indicate an issue with your vehicle that can be resolved by scheduling service.

You can also try charging your vehicle using a Tesla Supercharger or Destination Charging location, all of which can be located through the map on your vehicle's touchscreen display. See [Maps and Navigation on page 158](#) for more details.

For more information on troubleshooting Mobile Connector status lights and charging issues, refer to the [product's owner's manual](#).

For more information on charging, see [Charging Instructions on page 172](#).

UMC_w013

Wall plug adapter error - Charge rate reduced Plug adapter fully into Mobile Connector and retry

What this alert means:

Your Mobile Connector is unable to communicate with the wall plug adapter. Because your Mobile Connector cannot monitor the wall plug adapter temperature, charge current is automatically reduced to 8A.

What to do:

1. Unplug your Mobile Connector, including the wall plug adapter, completely from the wall outlet.
2. Make sure the connection between the wall plug adapter and the main body of your Mobile Connector is secure.
 - a. Disconnect the wall plug adapter completely from the main body of your Mobile Connector.
 - b. Fully reinsert the wall plug adapter into the main body of your Mobile Connector by pushing it into the socket until it snaps into place.
3. Try charging again by plugging the Mobile Connector, including wall plug adapter, fully into the wall outlet.
4. If the alert persists, try using a different wall plug adapter (see steps above to make sure the adapter is fully connected to your Mobile Connector).
 - a. If the alert is no longer present, the issue is likely with the wall plug adapter you were using previously.
 - b. If the alert persists, the issue is likely with your Mobile Connector.

If needed, obtain another wall plug adapter or Mobile Connector.

In the meantime, you can continue to charge with the same equipment. The charge rate will be reduced, as charge current will be limited to 8A while this condition persists.

You can also try charging your vehicle using a Tesla Supercharger or Destination Charging location, all of which can be located through the map on your vehicle's touchscreen display. See [Maps and Navigation on page 158](#) for more details.



Troubleshooting Alerts

For more information on troubleshooting Mobile Connector status lights and charging issues, refer to the [product's owner's manual](#).

UMC_w014

Wall plug adapter error - Charge rate reduced Plug adapter fully into Mobile Connector and retry

What this alert means:

Your Mobile Connector is unable to communicate with the wall plug adapter. Because your Mobile Connector cannot identify the type of wall outlet the wall plug adapter is connected to, charge current is automatically reduced to 8A.

What to do:

1. Unplug your Mobile Connector, including the wall plug adapter, completely from the wall outlet.
2. Make sure the connection between the wall plug adapter and the main body of your Mobile Connector is secure.
 - a. Disconnect the wall plug adapter completely from the main body of your Mobile Connector.
 - b. Fully reinsert the wall plug adapter into the main body of your Mobile Connector by pushing it into the socket until it snaps into place.
3. Try charging again by plugging the Mobile Connector, including wall plug adapter, fully into the wall outlet.
4. If the alert persists, try using a different wall plug adapter (see steps above to make sure the adapter is fully connected to your Mobile Connector).
 - a. If the alert is no longer present, the issue is likely with the wall plug adapter you were using previously.
 - b. If the alert persists, the issue is likely with your Mobile Connector.

If needed, obtain another wall plug adapter or Mobile Connector. In the meantime, you can continue to charge with the same equipment. The charge rate will be reduced, as charge current will be limited to 8A while this condition persists.

You can also try charging your vehicle using a Tesla Supercharger or Destination Charging location, all of which can be located through the map on your vehicle's touchscreen display. See [Maps and Navigation on page 158](#) for more details.

For more information on troubleshooting Mobile Connector status lights and charging issues, refer to the [product's owner's manual](#).

UMC_w015

Wall plug adapter error - Charge rate reduced Plug adapter fully into Mobile Connector and retry

What this alert means:

Your Mobile Connector is unable to communicate with the wall plug adapter. Because your Mobile Connector cannot identify the type of wall outlet the wall plug adapter is connected to, charge current is automatically reduced to 8A.

What to do:

1. Unplug your Mobile Connector, including the wall plug adapter, completely from the wall outlet.
2. Make sure the connection between the wall plug adapter and the main body of your Mobile Connector is secure.
 - a. Disconnect the wall plug adapter completely from the main body of your Mobile Connector.
 - b. Fully reinsert the wall plug adapter into the main body of your Mobile Connector by pushing it into the socket until it snaps into place.
3. Try charging again by plugging the Mobile Connector, including wall plug adapter, fully into the wall outlet.
4. If the alert persists, try using a different wall plug adapter (see steps above to make sure the adapter is fully connected to your Mobile Connector).
 - a. If the alert is no longer present, the issue is likely with the wall plug adapter you were using previously.



- b. If the alert persists, the issue is likely with your Mobile Connector.

If needed, obtain another wall plug adapter or Mobile Connector. In the meantime, you can continue to charge with the same equipment. The charge rate will be reduced, as charge current will be limited to 8A while this condition persists.

You can also try charging your vehicle using a Tesla Supercharger or Destination Charging location, all of which can be located through the map on your vehicle's touchscreen display. See [Maps and Navigation on page 158](#) for more details.

For more information on troubleshooting Mobile Connector status lights and charging issues, refer to the [product's owner's manual](#).

UMC_w016

Mobile Connector control box temperature high

Maximum charge rate reduced

What this alert means:

Charge current has been temporarily reduced because the Mobile Connector has detected increased temperature inside its control box housing.

What to do:

Make sure the Mobile Connector is not covered by anything, and that there is no heat source nearby. If the problem persists in normal ambient temperatures (under 38°C), service is required.

You can also try charging your vehicle using a Tesla Supercharger or Destination Charging location, all of which can be located through the map on your vehicle's touchscreen display. See [Maps and Navigation on page 158](#) for more details.

For more information on troubleshooting Mobile Connector status lights and charging issues, refer to the [product's owner's manual](#).

UMC_w017

Charge rate reduced - Wall plug temperature high

Wall outlet and wiring inspection recommended

What this alert means:

High temperature detected by Mobile Connector alerts indicate the outlet used to charge is becoming too warm, so charging has been slowed to protect the outlet.

This is not typically an issue with your vehicle or your Mobile Connector, but rather an issue with the outlet. A warm outlet may be caused by a plug that is not fully inserted, a loose building wiring connection to the outlet, or an outlet that is beginning to wear out.

What to do:

Make sure your adapter is fully plugged into the outlet. If charging speed does not return to normal, contact an electrician to inspect the outlet and building wiring connections to the outlet and complete any repairs needed.

If the outlet is worn, it should be replaced with a high-quality outlet. Consider upgrading to a Tesla Wall Connector for greater convenience and highest charging speed.

UMC_w018

Charge rate reduced - Handle temperature high

Check charge handle or charge port for debris

What this alert means:



Troubleshooting Alerts

Charge current has been temporarily reduced because the Mobile Connector has detected increased temperature in the charge handle that connects to your vehicle's charge port.

What to do:

Make sure the Mobile Connector is fully inserted into your vehicle's charge port inlet.

Inspect the charge port inlet and the Mobile Connector handle for any obstructions or moisture. Make sure any obstruction in the charge port or Mobile Connector handle has been removed and any moisture has been allowed to dry, then try re-inserting the Mobile Connector handle into the charge port.

Also make sure the charge handle of the Mobile Connector is not covered by anything, and that there is no heat source nearby.

If the alert persists in normal ambient temperatures (under 38°C), and occurs during multiple charging attempts, this may indicate a condition affecting the Mobile Connector or your vehicle. It is recommended that you schedule service at your convenience.

You can also try charging your vehicle using a Tesla Supercharger or Destination Charging location, all of which can be located through the map on your vehicle's touchscreen display. See [Maps and Navigation on page 158](#) for more details.

For more information on troubleshooting Mobile Connector status lights and charging issues, refer to the [product's owner's manual](#).

UMC_w019

Mobile Connector to adapter connection hot Maximum charge rate reduced

What this alert means:

Charge current has been reduced because the Mobile Connector has detected a high temperature at the connection between the wall plug adapter and the control box.

What to do:

Make sure the wall plug adapter is fully connected to the Mobile Connector control box.

After unplugging from the power source (wall outlet), inspect the wall plug adapter connection and the Mobile Connector control box connection for any obstructions or moisture.

It is recommended that any debris / foreign objects be removed. Make sure any obstruction has been removed and any moisture has been allowed to dry, then try re-inserting the wall plug adapter into the Mobile Connector and then connecting to the power source (wall outlet).

Also make sure the wall plug adapter is not covered by anything, and that there is no heat source nearby. If the alert persists in normal ambient temperatures (under 38°C), and occurs during multiple charging attempts, this may indicate a condition affecting the Mobile Connector or your vehicle. It is recommended that you schedule service at your convenience.

You can also try charging your vehicle using a Tesla Supercharger or Destination Charging location, all of which can be located through the map on your vehicle's touchscreen display. See [Maps and Navigation on page 158](#) for more details.

For more information on troubleshooting Mobile Connector status lights and charging issues, refer to the [product's owner's manual](#).



Document Applicability

For the latest and greatest information that is customized to your vehicle, view the Owner's Manual on your vehicle's touchscreen by touching **Controls > Service > Owner's Manual**. The information is specific to your vehicle depending on the features you purchased, vehicle configuration, market region and software version. In contrast, owner information that is provided by Tesla elsewhere is updated as necessary and may not contain information unique to your vehicle.

Information about new features is displayed on the touchscreen after a software update, and can be viewed at any time by touching **Controls > Software > Release Notes**. If the content in the Owner's Manual on how to use your vehicle conflicts with information in the Release Notes, the Release Notes take precedence.

Illustrations

The illustrations provided in this document are for demonstration purposes only. Depending on vehicle options, software version and market region, the information displayed on the touchscreen in your vehicle may appear slightly different.

Feature Availability

Some features are available only on some vehicle configurations and/or only in specific market regions. Options or features mentioned in the Owner's Manual does not guarantee they are available on your specific vehicle. See [Feature Availability Statement on page 269](#) for more information.

Errors or Inaccuracies

All specifications and descriptions are known to be accurate at time of publishing. However, because continuous improvement is a goal at Tesla, we reserve the right to make product modifications at any time. To communicate any inaccuracies or omissions, or to provide general feedback or suggestions regarding the quality of the Owner's Manual, send an email to ownersmanualfeedback@tesla.com.

Location of Components

Owner information may specify the location of a component as being on the left or right side of the vehicle. As shown, left (1) and right (2) represent the side of the vehicle when sitting inside.

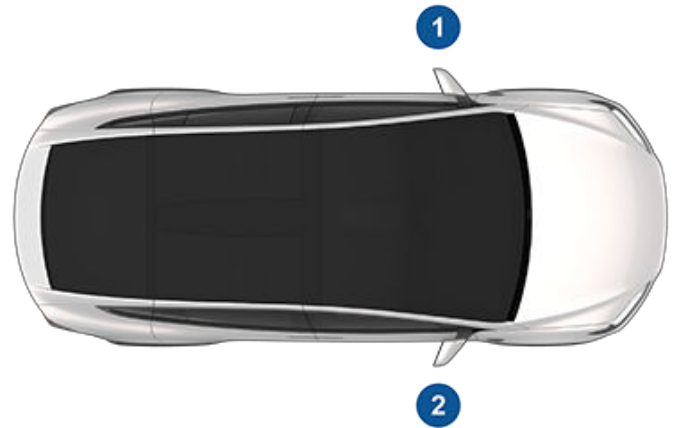

Copyrights and Trademarks

© 2012–2024 Tesla, Inc. All information in this document and all vehicle software is subject to copyright and other intellectual property rights of Tesla, Inc. and its licensors. This material may not be modified, reproduced or copied, in whole or in part, without the prior written permission of Tesla, Inc. and its licensors. Additional information is available upon request. Tesla uses software created by the Open Source community. Please visit Tesla's Open Source software website at <http://www.tesla.com/opensource>. HD Radio is a registered trademark of iBiquity Digital Corporation. The following are trademarks or registered trademarks of Tesla, Inc. in the United States and other countries:

TESLA

TESLA MOTORS

TESLA ROADSTER

MODEL S

MODEL X

MODEL 3

MODEL Y

CYBERTRUCK

T E S L A





About this Owner Information

All other trademarks contained in this document are the property of their respective owners and their use herein does not imply sponsorship or endorsement of their products or services. The unauthorized use of any trademark displayed in this document or on the vehicle is strictly prohibited.



Your Tesla is constantly changing, with new features being added and improved upon with every software update. However, depending on the firmware release operating on your vehicle, your vehicle may not be equipped with all features or may not operate exactly as described in this Owner's Manual. The features on your vehicle vary depending on market region, vehicle configuration, options purchased, software updates, and more.

Referencing options or features mentioned in this Owner's Manual does not guarantee they are available on your specific vehicle. The best way to ensure you are getting the latest and greatest features is update your vehicle's software as soon as you receive the notification to do so. You can also set your preferences to **Controls > Software > Software Preferences > Advanced**. See [Software Updates on page 182](#) for more information. For the features available on your vehicle, always comply with local laws and limits to ensure the safety of you, your passengers, and those around you.



Vehicle Telematics

Model X is equipped with electronic modules that monitor and record data from various vehicle systems, including the motor, Autopilot components, Battery, braking and electrical systems. The electronic modules record information about various driving and vehicle conditions, including braking, acceleration, trip and other related information regarding your vehicle. These modules also record information about the vehicle's features such as charging events and status, the enabling/disabling of various systems, diagnostic trouble codes, VIN, speed, direction and location.

The data is stored by the vehicle and may be accessed, used and stored by Tesla service technicians during vehicle servicing or periodically transmitted to Tesla wirelessly through the vehicle's telematics system. This data may be used by Tesla for various purposes, including, but not limited to: providing you with Tesla telematics services; troubleshooting; evaluation of your vehicle's quality, functionality and performance; analysis and research by Tesla and its partners for the improvement and design of our vehicles and systems; to defend Tesla; and as otherwise may be required by law. In servicing your vehicle, Tesla can potentially resolve issues remotely simply by reviewing your vehicle's data log.

Tesla's telematics system wirelessly transmits vehicle information to Tesla on a periodic basis. The data is used as previously described and helps ensure the proper maintenance of your vehicle. Additional Model X features may use your vehicle's telematics system and the information provided, including features such as charging reminders, software updates, and remote access to, and control of, various systems of your vehicle.

Tesla does not disclose the data recorded in your vehicle to any third party except when:

- An agreement or consent from the vehicle's owner (or the leasing company for a leased vehicle) is obtained.
- Officially requested by the police or other authorities.
- Used as a defense for Tesla.
- Ordered by a court of law.
- Used for research purposes without disclosing details of the vehicle owner or identification information.
- Disclosed to a Tesla affiliated company, including their successors or assigns, or our information systems and data management providers.

For additional information regarding how Tesla processes data collected from your vehicle, please review Tesla's Privacy Notice at <http://www.tesla.com/about/legal>.

Data Sharing

For quality assurance and to support the continuous improvement of advanced features such as Autopilot, your Model X may collect analytics, road segment, diagnostic, and vehicle usage data and send to Tesla for analysis. This analysis helps Tesla improve products and services by learning from the experience of billions of miles that Tesla vehicles have driven. Although Tesla shares this data with partners that contribute similar data, the collected information does not identify you personally and can be sent to Tesla only with your explicit consent. In order to protect your privacy, personal information is either not logged at all, is subject to privacy preserving techniques, or is removed from any reports before being sent to Tesla. You have control over what data you share by touching **Controls > Software > Data Sharing**.

For additional information regarding how Tesla processes data collected from your vehicle, please review Tesla's Privacy Notice at <http://www.tesla.com/about/legal>.

NOTE: Although Model X uses GPS in connection with driving and operation, as discussed in this document, Tesla does not record or store vehicle-specific GPS information, except the location where a crash occurred. Consequently, Tesla is unable to provide historical information about a vehicle's location (for example, Tesla is unable to tell you where Model X was parked/traveling at a particular date/time).

Quality Control

You might notice a few km on the odometer when you take delivery of your Model X. This is a result of a comprehensive testing process that ensures the quality of your Model X.

The testing process includes extensive inspections during and after production. The final inspection takes place at Tesla and includes a road test conducted by a technician.

Sound Library

"Free Sounds Library" (if equipped).

Free Sound Effects Site.

License: Attribution 4.0 International (CC BY 4.0). You are allowed to use sound effects free of charge and royalty free in your multimedia projects for commercial or non-commercial purposes.

<http://www.freesoundslibrary.com>



Contacting Tesla

For detailed information about your Model X, go to <http://www.tesla.com>, and log on to your Tesla account, or sign up to get an account.

If you have any questions or concerns about your Model X, call Tesla. To find the number for your region, go to <http://www.tesla.com> then view contact information.

Key and Passive Unlocking System

FCC Certification

Model Number	Mfr	Frequency	Tested For
Key fob 1048598	Tesla	2.4 GHz	USA Canada Mexico Taiwan
WC1	Tesla	127.7KHz	Global

The devices listed above comply with Part 15 of the FCC rules, Industry Canada's license-exempt RSS Standard(s) and EU Directive 2014/53/EU.

1. This device may not cause harmful interference, and
2. This device must accept any interference received, including interference that may cause undesired operation.

Changes or modifications not expressly approved by Tesla could void your authority to operate the equipment.

Radiation Exposure Statement

The product complies with FCC/IC RF Exposure for Low Power Consumer Wireless Power Transfer. The RF exposure limit set forth for an uncontrolled environment is safe for the operations intended, as described in this manual. Compliance was demonstrated at a distance of 20 cm or greater between the human body and the device. If the function is available, the device's output power could be lowered.

Central Body Controller

FCC Certification

Model Number	Mfr	MHz / GHz	Tested For
Central Body Controller 1031503	Tesla	315 / 2.4	USA Canada

Per FCC ID 2AEIM-1031503, the devices listed above comply with Part 15 of the FCC rules. Operation is subject to the following two conditions:

1. This device may not cause harmful interference, and
2. This device must accept any interference received, including interference that may cause undesired operation.

Changes or modifications not expressly approved by Tesla could void your authority to operate the equipment.

Integral Component Only

The Central Body Controller is an integral part of the vehicle that is installed and secured around other interior trim components. The Central Body Controller is designed and intended for use only as an integral component and cannot be sold and/or marketed separately.



Tire Pressure Monitoring System

FCC IDs: TZSTPMS201, Z9F-201FS43X

IC ID: 11852A-201FS4X

The tire pressure monitoring system (TPMS) complies with Part 15 of the FCC rules and RSS-210 of Innovation, Science and Economic Development Canada. Operation is subject to the following two conditions:

1. This device may not cause harmful interference, and
2. This device must accept any interference received, including interference that may cause undesired operation.

Changes or modifications not expressly approved by Tesla could void your authority to operate the equipment.

HomeLink

This device complies with Part 15 of the FCC rules, RSS-210 Industry Canada, and with EU Directive 2014/53/EU.

Operation is subject to the following conditions:

- This device may not cause harmful interference.
- This device must accept any interference received, including interference that may cause undesired operation.

Any changes or modifications to the device not expressly approved by the manufacturer or Tesla could void your authority to operate the equipment.

Radio Frequency Information

This equipment has been tested and found to comply with the limits for a Class B digital device, pursuant to Part 15 of the FCC Rules. These limits are designed to provide reasonable protection against harmful interference in a residential installation. This equipment generates, uses and can radiate radio frequency energy and, if not installed and used in accordance with the instructions, may cause harmful interference to radio communications. However, there is no guarantee that interference will not occur in a particular installation. If this equipment does cause harmful interference to radio or television reception, which can be determined by turning the equipment off and on, try to correct the interference by one or more of the following measures:

- Reorient or relocate the receiving antenna.
- Increase the separation between the equipment and receiver.
- Connect the equipment into an outlet on a circuit different from that to which the receiver is connected.
- Consult the dealer or an experienced radio/TV technician for help.



RF Modules

The devices described above comply with CE standards. Operation is subject to the following two conditions:

1. This device may not cause harmful interference, and
2. This device must accept any interference received, including interference that may cause undesired operation.

Changes or modifications not expressly approved by Tesla could void your authority to operate the equipment.

Description	Frequency Band	Power Level	Antenna Location
Keyfob	Transmit/Receive - 2.4 GHz Receive - 22 kHz	10 dB @ 2.4 GHz	n/a
Body/Security Controller	Transmit - 22 kHz Receive (NA) - 315 MHz Receive (EU) - 433 MHz Transmit/Receive -2.4 GHz	n/a (magnetic field)	Front passenger footwell
TPMS Sensor	433.9 MHz	2.5 mW	Each wheel
TPMS Module/Antenna	Receive - 433.9 MHz	n/a (Receive only)	Center spine
FM	88-108 MHz	n/a (Receive only)	Rear Window
DAB	174-241 MHz	n/a (Receive only)	Rear Window
Homelink (if equipped)	433.9 MHz	10 mW	Above front bumper beam
Bluetooth	2402-2480 MHz	2.5 mW max.	Left of center display
GSM (band 5/8)	Transmit - 824-849, 880-915 MHz Receive - 864-894, 925-960 MHz	2 W	Transmit - Right side mirror Receive - Right side mirror
GSM (band 2/3)	Transmit - 1710-1785, 1850-1910 MHz Receive - 1805-1880, 1930-1990 MHz	1 W	Transmit - Right side mirror Receive - Right side mirror
WCDMA (Band 5/6/19/8)	Transmit - 824-849, 880-915 MHz Receive - 864-894, 925-960 MHz	250 mW	Transmit - Right side mirror Receive - Right side mirror
WCDMA (Band 1/2/3/4)	Transmit - 1710-1785, 1850-1910, 1920-1980 MHz Receive - 1805-1880, 1930-1990, 2110-2170 MHz	250 mW	Transmit - Right side mirror Receive - Right side mirror
LTE (band 5/19/26/8/20/28)	Transmit - 703-748, 814-849, 832-862, 880-915 MHz Receive - 758-803, 791-821, 859-894, 925-960 MHz	200 mW	Transmit - Right side mirror Receive - Right side mirror



Description	Frequency Band	Power Level	Antenna Location
LTE (band 21/32)	Transmit - 1447.9-1462.9 MHz Receive - 1452-1510.9 MHz	200 mW	Transmit - Right side mirror Receive - Right side mirror
LTE (band 1/2/3/4)	Transmit - 1710-1785, 1850-1910, 1920-1980 MHz Receive - 1805-1880, 1930-1990, 2110-2170 MHz	200 mW	Transmit - Right side mirror Receive - Right side mirror
LTE (band 7)	Transmit - 2500-2570 MHz Receive - 2620-2690 MHz	200 mW	Transmit - Right side mirror Receive - Right side mirror
Wi-Fi	2400-2483.5 MHz 5180-5825 MHz	100 mW	Left side mirror Left side mirror/B-header in the middle ceiling
GPS	1593-1610 MHz	n/a (Receive only)	Between windshield and rear view mirror
Drivers Assistance Radar	77 GHz	22 W	Behind lower grill and front bumper



A

- ABS (Anti-lock Braking System): [86](#)
- absolute speed limit: [141](#)
- accessories: [10](#)
 - plugging into power socket: [10](#)
- accessory carrier: [104](#)
- adjacent lane speed: [114](#)
- aero covers: [187](#)
- air conditioning: [149](#)
- air filter: [154](#)
- airbags (location): [61](#)
- alarm: [143](#), [146](#)
- all-season tires: [189](#)
- always connected, setting: [181](#)
- Always Show Estimated Round Trip Energy: [162](#)
- anti-lock braking (ABS): [86](#)
- apps: [6](#)
- Arcade: [165](#)
- audio: [77](#), [163](#), [165](#)
 - playing files: [163](#), [165](#)
 - settings: [163](#)
 - steering wheel buttons: [77](#)
 - volume control: [163](#)
- Auto Lane Change: [114](#)
- automatic emergency braking: [139](#)
- automatic navigation: [158](#)
 - navigating: [158](#)
- Autopark: [123](#)
- autopilot: [135](#)
 - side collision warning: [135](#)
- Autopilot: [112](#), [114](#), [118](#), [123](#), [125](#), [138](#), [141](#)
 - automatic emergency braking: [138](#)
 - Autopark: [123](#)
 - collision avoidance assist: [138](#)
 - forward collision warning: [138](#)
 - overtake acceleration: [114](#), [118](#)
 - overview: [112](#)
 - speed assist: [141](#)
 - speed limit warning: [141](#)
 - staying within speed limits: [141](#)
 - Summon: [125](#)
 - Traffic-Aware Cruise Control: [114](#), [118](#)
- Autopilot components: [112](#)
- average range: [181](#)

B

- backup camera: [101](#)
- Battery (high voltage): [170](#), [209](#)
 - specifications: [209](#)

- temperature limits: [170](#)
- battery (key), replacing: [21](#)
- battery (low voltage): [170](#), [209](#)
 - complete discharge: [170](#)
 - specifications: [209](#)
- bicycle carrier: [104](#)
- Blind Spot Camera: [135](#)
- Blind Spot Collision Warning: [135](#)
- Blind Spot Collision Warning Chime: [135](#)
- Bluetooth: [69](#), [71](#), [165](#)
 - devices, playing audio files from: [165](#)
 - general information: [69](#), [71](#)
 - phone, pairing and using: [69](#)
- body repairs: [198](#)
- body touch up: [193](#)
- Boombox: [165](#), [166](#)
- booster seats - child safety: [44](#)
- brakes: [86](#), [139](#), [207](#)
 - automatic in emergencies: [139](#)
 - overview of: [86](#)
 - specifications: [207](#)

C

- cabin air filter: [154](#)
- cabin temperature control: [149](#)
- Calendar: [71](#)
- calibration of doors: [20](#)
- camera, rear-facing: [101](#)
- Camp: [152](#)
- car cover: [193](#)
- car status, displaying: [77](#), [78](#)
- car washes: [191](#)
- Caraoke): [165](#)
- cargo area: [31](#)
- cargo volume (specifications): [206](#)
- carpets, cleaning: [193](#)
- CCS (Combo): [169](#)
- certifications, CE: [272](#)
- certifications, FCC: [272](#)
- certifications, IC: [272](#)
- certifications, NCC: [272](#)
- CHAdEMO: [169](#)
- chains: [189](#)
- change of ownership: [9](#)
- charge port: [172](#)
- charge port light: [173](#)
- charge port manual release: [176](#)
- charge port release cable: [176](#)
- charging: [168](#), [169](#), [172](#), [173](#)
 - charge settings: [173](#)



- charging status: [173](#)
- components and equipment: [168](#)
- instructions: [172](#)
- public charging stations: [169](#)
- scheduling: [173](#)
- charging locations, finding: [161](#)
- charging stations, displaying on map: [158](#)
- child protection: [28](#)
 - disabling rear window switches: [28](#)
- child restraint and safety systems: [44](#)
- child safety seats, restraint systems: [44](#)
- child seats(disable front passenger airbag: [62](#)
- child-protection lock: [26](#)
 - disabling liftgate and rear door handles: [26](#)
- cleaning: [191](#)
- climate controls: [149](#)
- cold weather: [155](#)
- cold weather best practices: [155](#)
- collision avoidance assist: [138](#)
- Colorizer: [165](#)
- connecting to Wi-Fi: [68](#)
- console: [10](#), [35](#)
 - cup holders: [35](#)
 - low voltage power socket: [10](#)
 - USB ports: [10](#)
- consumption chart: [181](#)
- contact information: [216](#)
 - roadside assistance: [216](#)
- copyrights: [267](#)
- Creep: [88](#)
- cruise control: [114](#), [118](#)
- cup holders: [35](#)

D

- dashboard overview: [4](#)
- Dashcam: [145](#)
- data recording: [270](#)
- data sharing: [270](#)
- delivery mileage: [270](#)
- devices: [10](#), [165](#)
 - Bluetooth, playing audio files: [165](#)
 - connecting: [10](#)
- dimensions, overhand: [204](#)
- disable front passenger airbag: [62](#)
- display settings: [6](#)
- Dog: [152](#)
- door labels: [203](#)
- door seals: [193](#)
 - cleaning: [193](#)
- Door Unlock Mode: [26](#)

- doors: [20](#), [219](#)
 - opening from interior: [219](#)
 - opening with no power: [219](#)
- doors, opening: [20](#)
- drive away locking: [26](#)
- drive mode, Drive: [82](#)
- drive mode, Neutral: [82](#)
- drive mode, Park: [82](#)
- drive mode, Reverse: [82](#)
- drive modes, shifting: [82](#)
- driver: [36](#), [98](#)
 - profiles: [98](#)
 - seat adjustment: [36](#)
- driver assistance: [112](#)
- driving: [36](#), [76](#), [180](#)
 - seating position: [36](#)
 - starting: [76](#)
 - tips to maximize range: [180](#)

E

- Easy Entry: [38](#), [39](#)
- easy entry, driver profile: [98](#)
- electric parking brake: [88](#)
- emergency braking: [138](#)
- Emergency Lane Departure Avoidance: [135](#)
- emergency lights: [84](#)
- emergency rear door opening: [219](#)
- energy: [87](#)
 - gained from regenerative braking: [87](#)
- Energy app: [181](#)
- energy saving mode: [181](#)
- energy use predictions (navigating): [162](#)
- energy, range information: [11](#)
- Entertainment: [165](#)
- Erase & Reset: [9](#)
- event data recording: [270](#)
- exterior: [3](#), [191](#), [193](#)
 - car cover: [193](#)
 - cleaning: [191](#)
 - overview: [3](#)
 - polishing, touch up, & repair: [193](#)
- exterior (dimensions): [204](#)
- exterior dimensions: [204](#)

F

- factory defaults, restoring: [9](#)
- factory reset: [9](#)
- favorites (Media Player): [165](#)
- Favorites (navigation): [158](#)
- FCC and IC certifications: [272](#)



- feature availability: [269](#)
- features, downloading new: [182](#)
- firmware (software) updates: [182](#)
- flash drive: [145](#), [146](#)
- flashers, hazard warning: [84](#)
- floor mats: [194](#)
- fluids: [184](#)
 - replacement intervals: [184](#)
- forward collision warning: [138](#)
- front and rear seats: [36](#)
- front passenger detection: [62](#)
- front trunk: [32](#), [217](#)
 - opening with no power: [217](#)

G

- gaming controllers: [165](#)
- garage doors, opening: [73](#)
- gates, opening: [73](#)
- glovebox: [34](#)
- Glovebox PIN: [143](#)
- ground clearance: [204](#)

H

- hazard lights: [84](#)
- hazards: [84](#)
- head restraints: [40](#)
- head supports: [40](#)
- headlights, Auto High Beam: [83](#)
- headlights, high beam: [83](#)
- heating: [149](#)
- height adjustments (suspension): [197](#)
 - disabling (Jack mode): [197](#)
- height adjustments, air suspension: [90](#)
- high beam headlights: [83](#)
- high voltage: [168](#), [184](#), [209](#)
 - Battery specifications: [209](#)
 - components: [168](#)
 - safety: [184](#)
- hills, stopping on: [94](#)
- Hold: [88](#)
- Home: [6](#)
 - button: [6](#)
 - screen: [6](#)
- Home location: [160](#)
- HomeLink: [73](#), [125](#), [273](#)
 - FCC certification: [273](#)
 - programming and using: [73](#)
 - when using Summon: [125](#)
- hood: [32](#), [217](#)
 - opening with no power: [217](#)

- horn: [78](#)
- hub caps: [187](#)

I

- I'm Feeling Lucky, Hungry: [158](#)
- information, radio frequency: [272](#)
- instant range: [181](#)
- instructions, towing: [212](#)
- instrument panel: [193](#)
 - cleaning: [193](#)
- instrument panel, overview: [11](#)
- interior: [4](#), [149](#), [192](#)
 - cleaning: [192](#)
 - overview: [4](#)
 - temperature control: [149](#)
- interior (dimensions): [204](#)
- interior specifications: [204](#)
- intrusion detection: [143](#)
- ISOFIX - child safety: [44](#)

J

- J1772: [169](#)
- Jack mode: [197](#)
- jacking: [197](#)
- jump start: [216](#), [218](#)

K

- Keep Climate On: [152](#)
- key: [20](#), [21](#), [22](#)
 - how to use: [20](#)
 - ordering extras: [22](#)
 - replacing battery: [21](#)
- key fob: [76](#)
 - key fob not inside: [76](#)
- keyless entry: [20](#)

L

- label: [203](#)
 - Statutory Plate: [203](#)
 - Tire Information: [203](#)
- lane assist: [135](#)
- Lane Departure Avoidance: [135](#)
- liftgate: [30](#)
 - adjust opening height: [30](#)
 - opening: [30](#)
- lifting: [197](#)
- lights, dome (map): [83](#)
- lights, exterior: [83](#)
- lights, fog: [83](#)
- lights, hazard warning: [84](#)



lights, interior: [83](#)
load limits: [203](#)
location tracking: [158](#)
locking and unlocking doors: [20](#)
lug nut covers: [187](#)
lumbar support: [36](#)

M

maintenance: [183](#), [184](#), [185](#), [191](#), [195](#), [196](#)
 cleaning: [191](#)
 daily checks: [183](#)
 fluid replacement intervals: [184](#)
 monthly checks: [183](#)
 periodic checks: [184](#)
 replacing wiper blades: [195](#)
 service intervals: [183](#)
 tires: [185](#)
 washer fluid, topping up: [195](#)
 washer jets, cleaning: [196](#)
map orientation: [158](#)
map updates: [162](#)
mats: [194](#)
media: [163](#), [165](#)
 settings: [163](#)
 sources, show and hide: [163](#)
mileage upon delivery: [270](#)
mirrors: [80](#)
mobile app: [66](#)
mobile app access: [66](#)
Mobile Connector: [169](#), [172](#)
 description: [169](#)
 using: [172](#)
modifications: [198](#)
motor specifications: [206](#)
My Apps: [7](#)
my car does what?: [165](#)

N

naming your vehicle: [9](#)

O

Obstacle-Aware Acceleration: [138](#)
odometer: [100](#)
Off-Peak Charging: [178](#)
offset from speed limit: [141](#)
Online Routing: [162](#)
overtake acceleration: [114](#), [118](#)
Owner Information, about: [267](#)

P

Park Assist: [92](#)
parking brake: [88](#)
parking, using Autopark: [123](#)
parking, using Summon: [125](#)
parking, when towing a trailer: [108](#)
parts replacement: [198](#)
pedestrian warning: [102](#)
personal data, erasing: [9](#)
phone: [69](#), [71](#), [78](#)
 app: [71](#)
 connecting: [69](#)
 importing contacts: [69](#)
 in call options: [71](#)
 making a call: [71](#)
 pairing: [69](#)
 receiving a call: [71](#)
 recent calls: [69](#)
 steering wheel buttons: [78](#)
phone app: [71](#)
PIN: [98](#)
PIN to Drive: [143](#)
power: [87](#)
 gained from regenerative braking: [87](#)
power cycling: [76](#)
power management: [181](#)
power socket: [10](#)
power windows: [28](#), [201](#)
powered liftgate: [26](#)
powering on and off: [76](#)
Preconditioning: [178](#)
public charging stations: [169](#)

R

radio: [163](#), [165](#)
range: [87](#), [180](#)
 driving tips to maximize: [180](#)
 regenerative braking: [87](#)
range assurance: [180](#)
Range mode: [180](#)
range, displayed on instrument panel: [11](#)
re-naming your vehicle: [9](#)
Re-route: [162](#)
rear seats, accessing: [38](#), [39](#)
rear view camera: [101](#)
rear window switches, disabling: [28](#)
recent (Media Player): [165](#)
Recents (navigation): [158](#)
recording: [145](#), [146](#)



regenerative braking: [87](#)
relative speed limit: [141](#)
release notes: [182](#)
restarting the touchscreen: [76](#)
RFID transponders: [198](#)
ride height, air suspension: [90](#)
roadside assistance: [216](#)
Roll: [88](#)
rotating tires: [186](#)
Round Trip Energy (navigating): [162](#)
run out of range: [216](#), [218](#)

S

safety information: [43](#), [65](#)

- airbags: [65](#)
- seat belts: [43](#)

Schedule: [178](#)
schedule service: [66](#)
scheduled charging: [178](#)
scheduled departure: [178](#)

- using: [178](#)

seat belts: [41](#), [42](#), [193](#)

- cleaning: [193](#)
- in a collision: [42](#)
- overview of: [41](#)
- pre-tensioners: [42](#)
- wearing when pregnant: [42](#)

seat covers: [40](#)
seat heaters: [149](#)
seating capacity: [203](#)
seats: [36](#), [149](#)

- adjusting: [36](#)
- heaters: [149](#)

seats, second row: [36](#)
security settings: [143](#)
self-leveling: [90](#)
Sentry Mode: [146](#)
service data recording: [270](#)
service intervals: [183](#)
Settings, erasing: [9](#)
shifting drive modes: [82](#)
shortcuts: [7](#), [8](#)

- adding to My Apps: [7](#)
- restarting the touchscreen: [8](#)

Show Calendar Upon Entry: [71](#)
side camera(s): [101](#)
Side Clearance (Summon): [125](#)
side collision warning: [135](#)
Smart Summon: [128](#)
Software Reinstall: [182](#)

software reset: [9](#)
software update preferences: [182](#)
software updates: [182](#)
specifications: [206](#), [207](#), [209](#)

- brakes: [207](#)
- High Voltage Battery: [209](#)
- low voltage battery: [209](#)
- motor: [206](#)
- steering: [207](#)
- subsystems: [206](#)
- suspension: [207](#)
- tires: [209](#)
- transmission: [206](#)
- wheels: [209](#)

specifications (dimensions): [204](#)
specifications (exterior): [204](#)
speed assist: [141](#)
speed limit warning: [141](#)
spoiler: [103](#)
stability control: [95](#)
standby: [146](#)
starting: [76](#)
Statutory Plate: [203](#)
steering specifications: [207](#)
Stopping Mode: [88](#)
submerged vehicle: [220](#)
summer tires: [189](#)
Summon: [125](#)
Summon Distance: [125](#)
sun visors: [29](#)
Superchargers, displaying on map: [158](#)
Supercharging: [176](#)

- congestion fees: [176](#)
- described: [176](#)
- idle fees: [176](#)
- pay-per-use fees: [176](#)

suspension: [90](#)
suspension specifications: [207](#)
suspension, air: [90](#)
suspension, auto-raising: [90](#)
suspension, damping: [90](#)

T

Technically Permissible Maximum Laden Mass: [203](#)
Technically Permissible Maximum Mass on Axle: [203](#)
telematics: [270](#)
temperature: [78](#), [149](#), [170](#)

- Battery (high voltage), limits: [170](#)
- cabin, controls for: [149](#)
- heated: [78](#)



- temperature, outside: [11](#)
 - tesla profiles: [98](#)
 - Teslacam: [145](#), [146](#)
 - third row seats, accessing: [38](#), [39](#)
 - third row seats, folding and raising: [39](#)
 - tie-down straps: [214](#)
 - Tire Information label: [203](#)
 - tire noise: [189](#)
 - Tire Pressure Monitoring System: [188](#)
 - overview of: [188](#)
 - Tire Pressure Monitoring System, FCC certification: [273](#)
 - tire pressures, checking: [185](#)
 - tire pressures, displaying: [185](#)
 - tire pressures, when towing: [106](#)
 - tires: [185](#), [186](#), [189](#), [209](#), [210](#)
 - all-season: [189](#)
 - balancing: [186](#)
 - chains: [189](#)
 - inspecting and maintaining: [185](#)
 - pressures, displaying: [185](#)
 - pressures, how to check: [185](#)
 - replacing: [186](#)
 - replacing a tire sensor: [189](#)
 - rotation: [186](#)
 - specification: [209](#)
 - summer: [189](#)
 - tire markings: [210](#)
 - wheel configuration: [185](#)
 - winter: [189](#)
 - toll system transponders, attaching: [198](#)
 - torque specifications: [206](#)
 - touch up body: [193](#)
 - touchscreen: [6](#), [7](#), [8](#), [182](#), [193](#)
 - adding shortcuts: [7](#)
 - cleaning: [193](#)
 - customizing My Apps: [7](#)
 - display settings: [6](#)
 - frozen: [8](#)
 - main: [6](#)
 - overview: [6](#)
 - rear: [6](#)
 - reboot: [8](#)
 - software updates: [182](#)
 - unresponsive: [8](#)
 - tow eye, locating: [213](#)
 - tow hitch, connecting: [109](#)
 - tow hitch, disconnecting: [110](#)
 - towing: [212](#), [216](#), [218](#)
 - towing a trailer: [104](#)
 - towing capacity: [105](#)
 - towing guidelines: [108](#)
 - Towing Label: [203](#)
 - Toybox: [165](#)
 - TPMAM: [203](#)
 - TPMLM: [203](#)
 - TPMS: [188](#)
 - overview of: [188](#)
 - TPMS, FCC certification: [273](#)
 - Tracking Disabled: [158](#)
 - traction control: [95](#)
 - trademarks: [267](#)
 - Traffic-Aware Cruise Control: [114](#), [118](#)
 - Trailer Brakes for towing: [107](#)
 - Trailer Mode: [106](#)
 - trailer towing: [104](#)
 - transmission specifications: [206](#)
 - transponders, attaching: [198](#)
 - Transport Mode: [213](#)
 - transporting: [212](#)
 - transporting your vehicle: [212](#)
 - trip chart: [181](#)
 - trip meter: [100](#)
 - Trip Planner: [162](#)
 - trunk, front: [32](#)
 - trunk, rear: [26](#), [30](#)
 - child lock: [26](#)
 - disabling interior handle: [26](#)
 - turn signals, lights: [84](#)
- ## U
- Unlock on Park: [20](#)
 - unlocking when key fob doesn't work: [26](#)
 - USB devices: [10](#)
 - connecting: [10](#)
 - USB flash drive: [143](#), [145](#), [146](#)
 - USB ports: [10](#)
- ## V
- Valet mode: [98](#)
 - Vehicle Hold: [94](#)
 - vehicle identification labels: [202](#)
 - Vehicle Identification Number (VIN) labels: [202](#)
 - vehicle lights: [83](#)
 - vehicle loading: [203](#)
 - ventilation: [154](#)
 - vents, adjusting: [154](#)
 - video clips: [145](#)
 - View Live Camera: [146](#)
 - voice commands: [17](#)
 - volume control: [6](#)



volume control (media): [163](#)

W

Walk-Away Door Lock: [26](#)

Wall Connector: [169](#)

warm weather best practices: [157](#)

warning flashers: [84](#)

washer fluid, topping up: [195](#)

washer jets, cleaning: [196](#)

washers, using: [85](#)

wheel chocks: [214](#)

wheels: [186](#), [187](#), [209](#)

- aero covers, removing and installing: [187](#)

- alignment: [186](#)

- lug nut covers, removing and installing: [187](#)

- replacing: [186](#)

- specifications: [209](#)

- torque: [209](#)

Wi-Fi, connecting to: [68](#)

windshield washer fluid, topping up: [195](#)

winter tires: [189](#)

wiper blades, replacing: [195](#)

wiper defrosters: [85](#)

wipers, defrosting: [85](#)

wipers, using: [85](#)

Work location: [160](#)

TESLA

Publication date: 2024/12/13